

# JU-87 STUKA GIANT SCALE

“ Graphics and specifications may change without notice “ .

Code: SEA284



## Specifications:

- Wingspan-----90 in (228.6 cm).
- Wing area-----1328.7 sq.in (85.7 sq.dm).
- Weight-----17.6 lbs (8.0 kg).
- Length-----68.3 in (173.4 cm).
- Gasoline Engine-----38-50cc
- Radio-----7 channels with 7 servos.



## INTRODUCTION.

Thank you for choosing the **JU-87 ARF** by **SG MODELS** . The **JU-87** was designed with the intermediate/advanced sport flyer in mind. It is a semi scale airplane which is easy to fly and quick to assemble. The airframe is conventionally built using balsa, plywood to make it stronger than the average ARF, yet the design allows the aeroplane to be kept light. You will find that most of the work has been done for you already. The motor mount has been fitted and the hinges are pre-installed. Flying the **JU-87** is simply a joy.

This instruction manual is designed to help you build a great flying aeroplane. Please read this manual throughly before starting assembly of your **JU-87** . Use the parts listing below to indentify all parts.

## WARNING.

***Please be aware that this aeroplane is not a toy and if assembled or used incorrectly it is capable of causing injury to people or property. WHEN YOU FLY THIS AEROPLANE YOU ASSUME ALL RISK & REPONSIBILITY.***

If you are inexperienced with basic R/C flight we strongly recommend you contact your R/C supplier and join your local R/C model Flying Club. R/C Model Flying Clubs offer a variety of training procedures designed to help the new pilot on his way to successful R/C flight. They will also be able to advise on any insurance and safety regulations that may apply.

## KIT CONTENTS

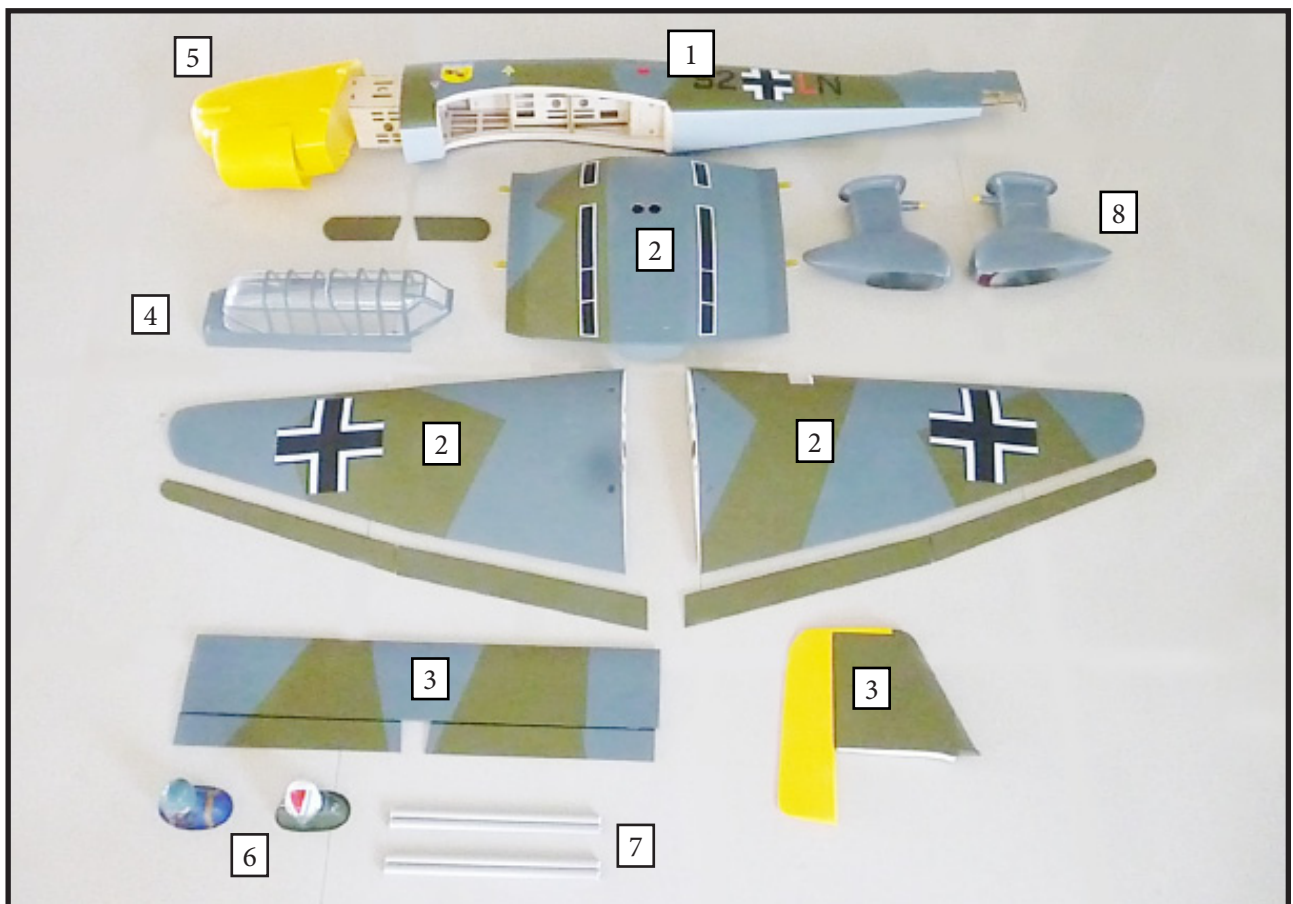

## KIT CONTENTS.

### SEA284 JU-87 STUKA GIANT

1. Fuselage
2. Wing set
3. Tail set
4. Canopy
5. Cowling
6. Pilot
7. Aluminum wing tube
8. Wheel pants

## ADDITIONAL ITEMS REQUIRED.

- 38-50cc gasoline engine.
- Computer radio with 7 servos.
- Glow plug to suit engine.
- Propeller to suit engine.
- Protective foam rubber for radio system.

## TOOLS & SUPPLIES NEEDED.

- Thin cyanoacrylate glue.
- Medium cyanoacrylate glue.
- 30 minute epoxy.
- 5 minute epoxy.
- Hand or electric drill.
- Assorted drill bits.
- Modelling knife.
- Straight edge ruler.
- 2mm ball driver.
- Phillips head screwdriver.
- 220 grit sandpaper.
- 90° square or builder's triangle.
- Wire cutters.
- Masking tape & T-pins.
- Thread-lock.
- Paper towels.

## HINGING THE AILERON.

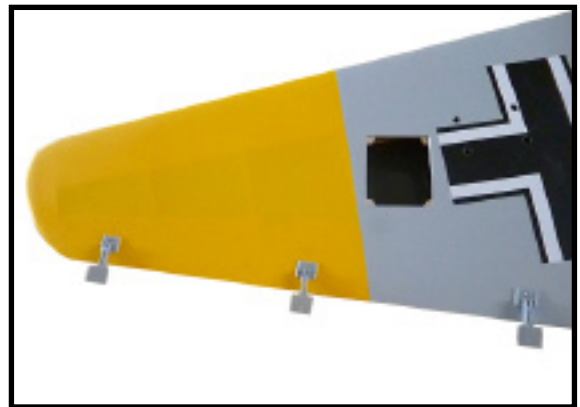
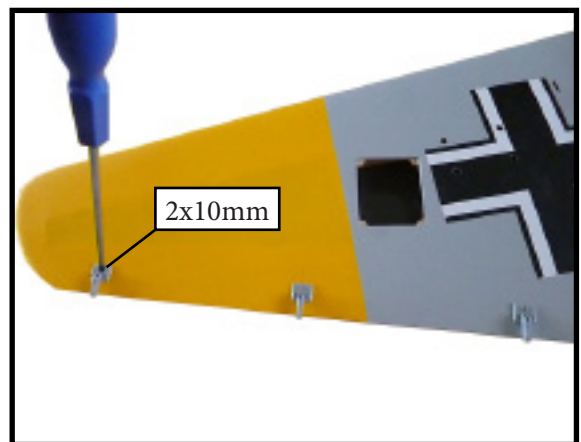
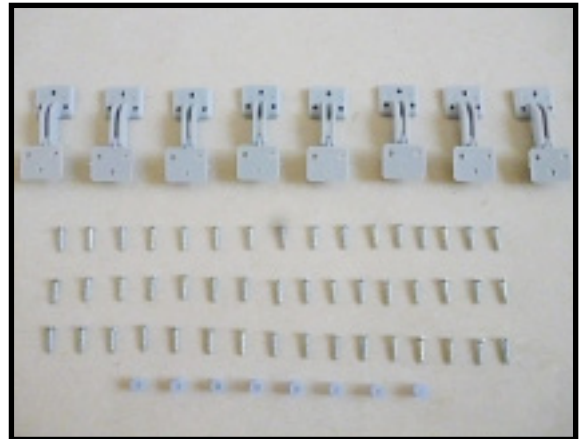

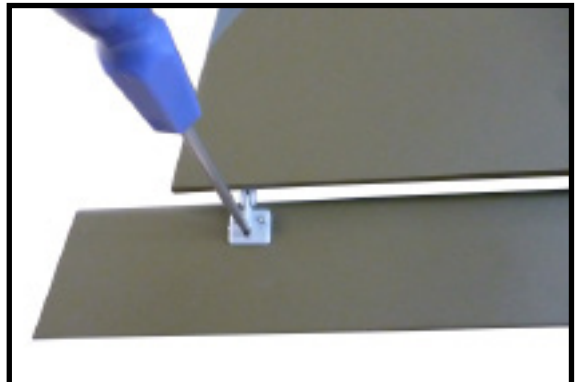
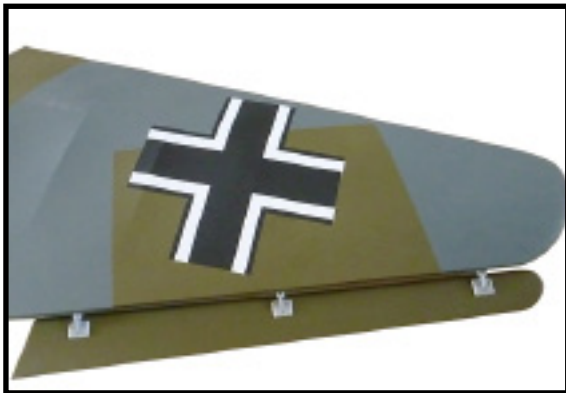
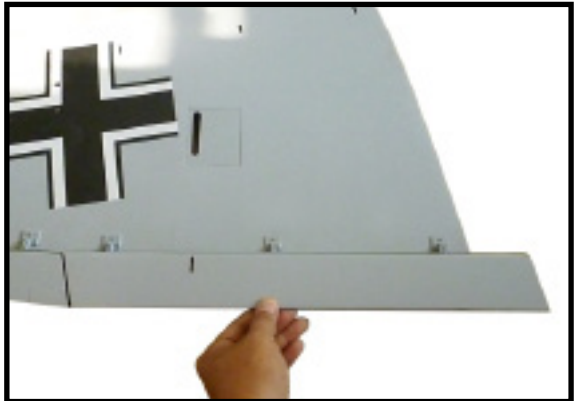
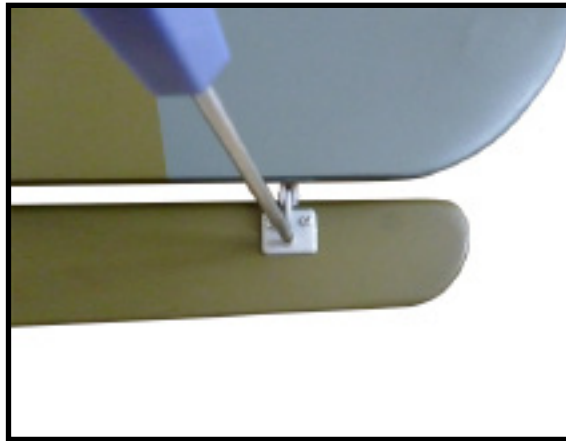
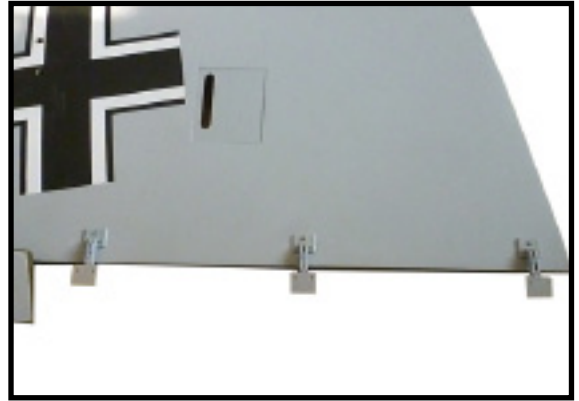

**HINGING THE FLAP.**

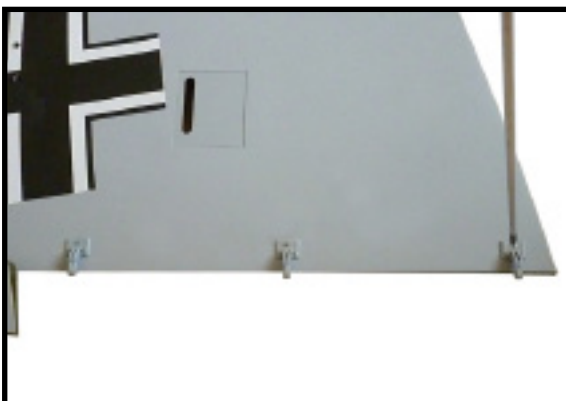

**INSTALL THE AILERONS CONTROL HORN.**

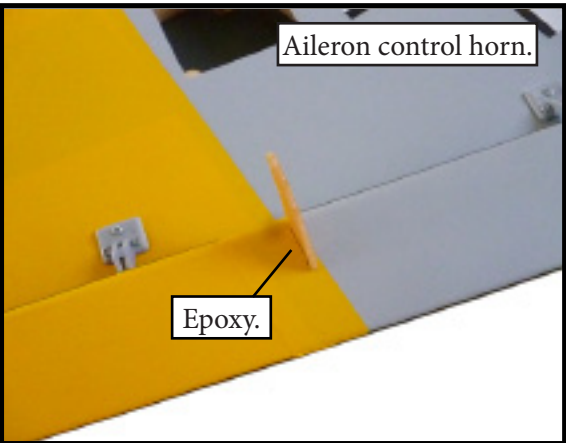
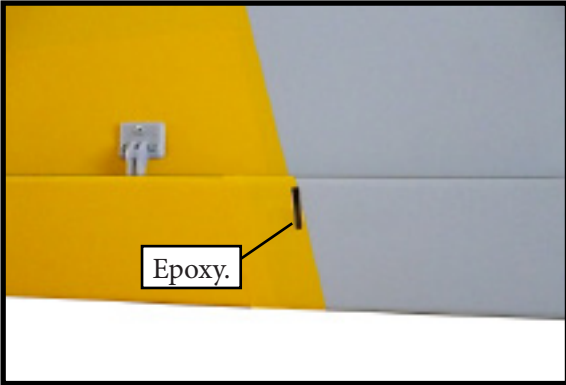
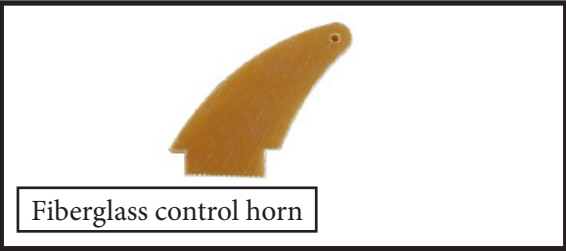

**INSTALL FLAP CONTROL HORN.**

Install the flap control horn using the same method as same as the aileron control horns.

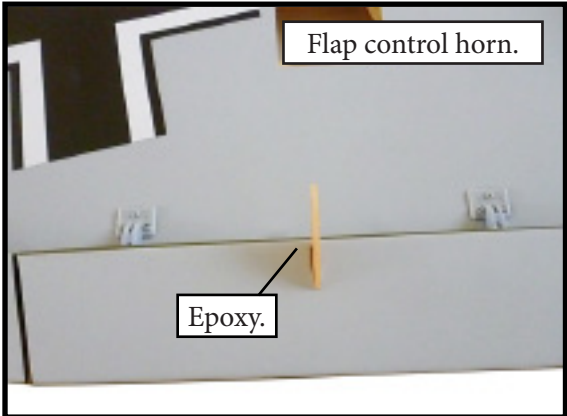
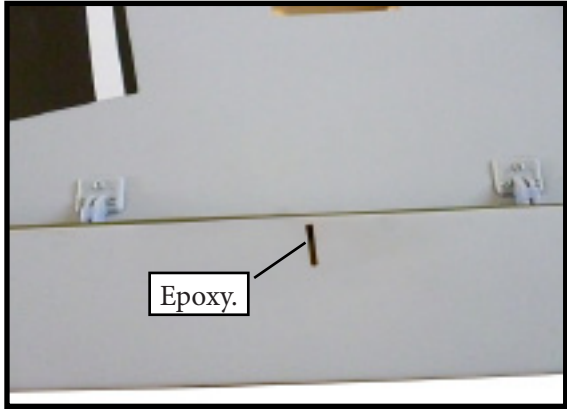
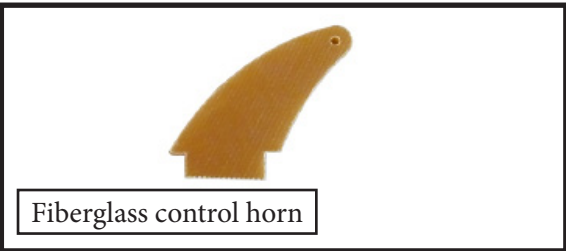

**INSTALL LED LIGHT.**

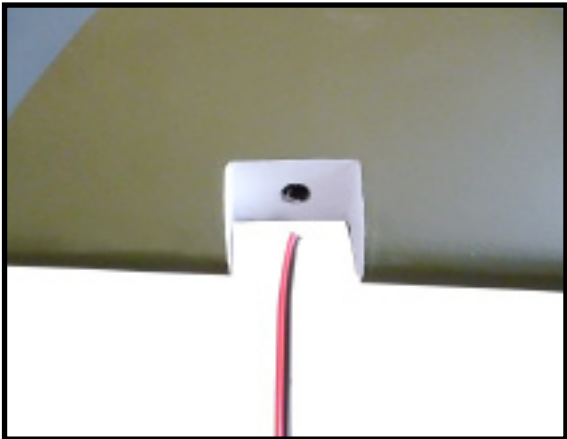
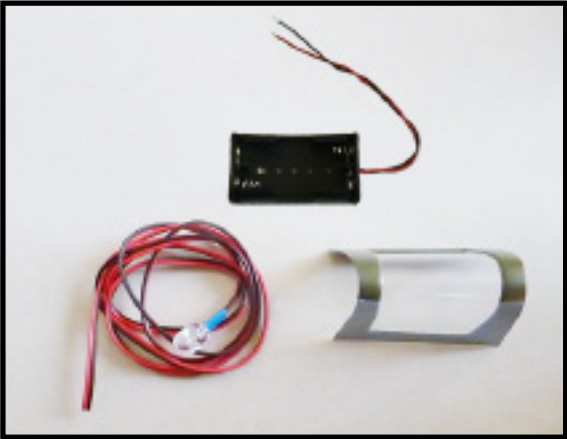

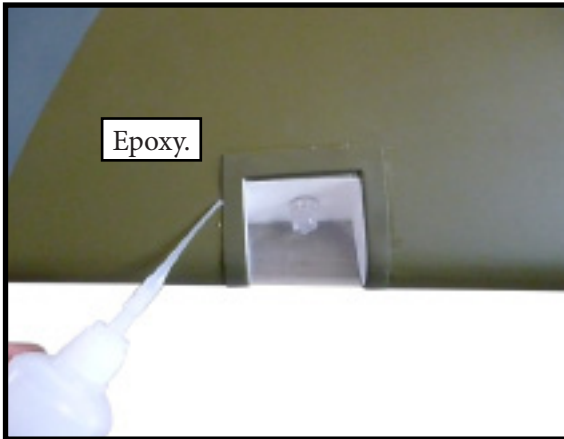
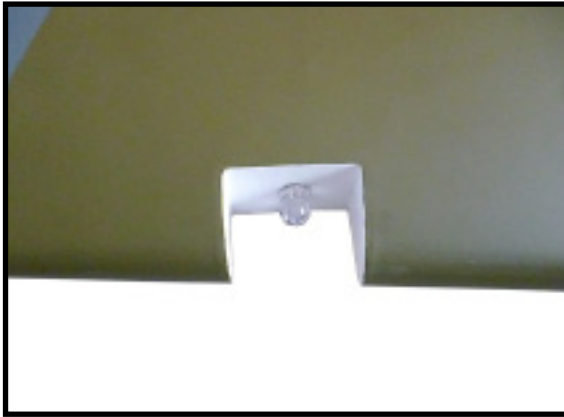

**HINGING THE FLAP FOR CENTER WING.**

1) Repeat steps to install hinging for center wing as same as steps done for ailerons.



2) Then, fit the joiner wire into the flap of center wing as below pictures.

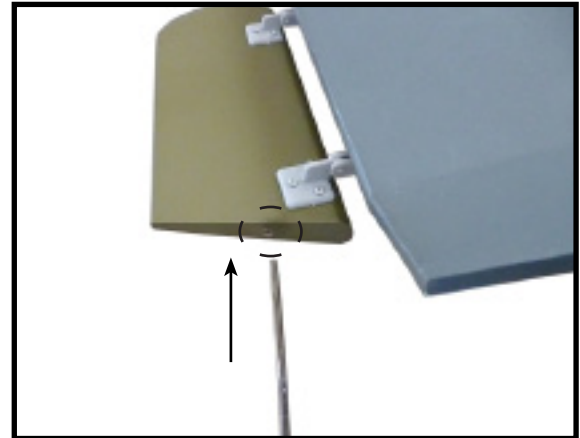
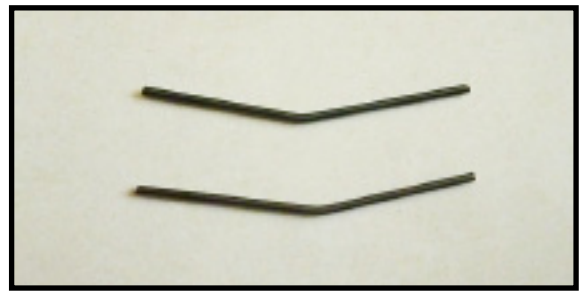

3) Slide the wing tube into the wing tube socket.

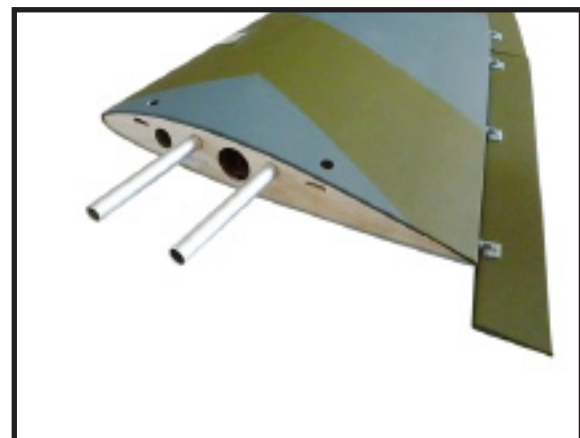

4) Slide the wing panel into position, guiding the extensions from the side wing into center wing.

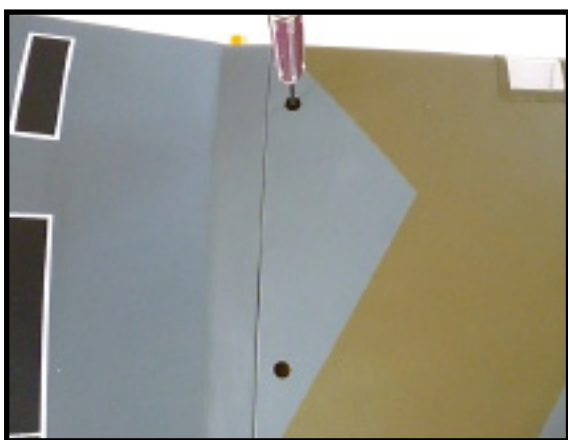
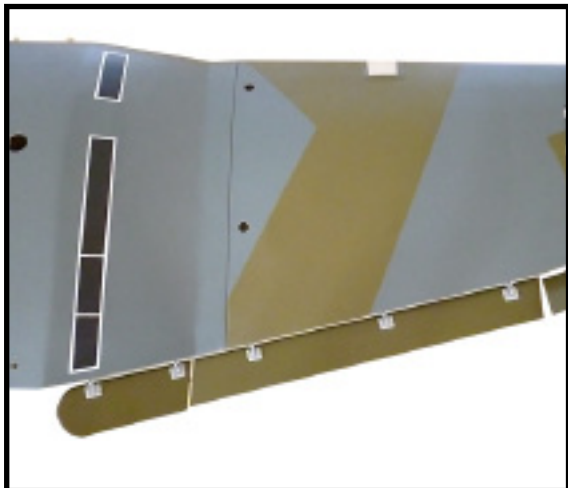
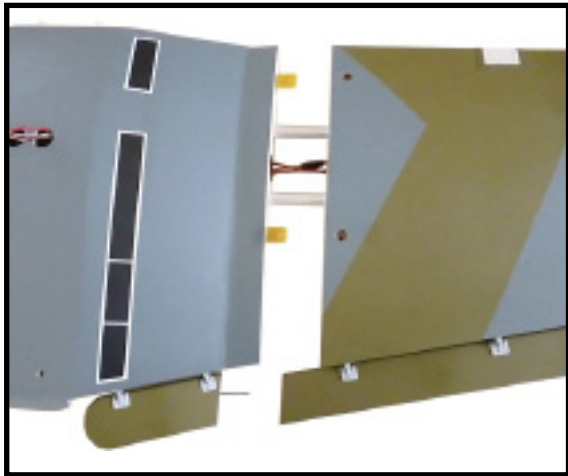

## INSTALLING THE AILERON SERVOS.

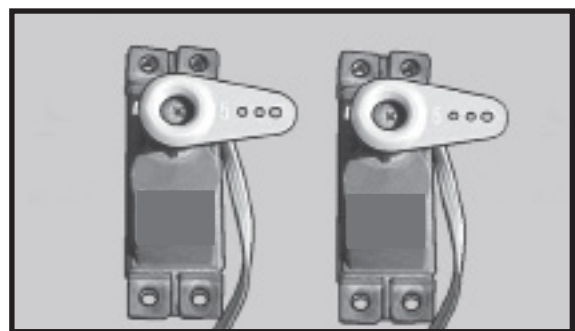
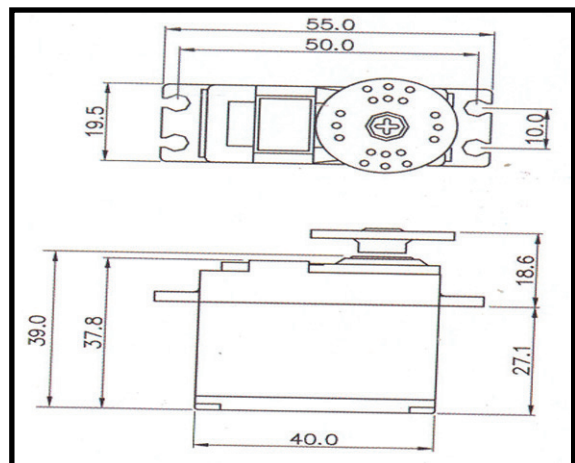

 Because the size of servos differ, you may need to adjust the size of the precut opening in the mount. The notch in the sides of the mount allow the servo lead to pass through.

1) Using a small weight (Weighted fuel pick-up works well) and string, feed the string through the wing as indicated.

2) Place the servo between the mounting blocks and space it from the hatch. Use a pencil to mark the mounting hole locations on the blocks.

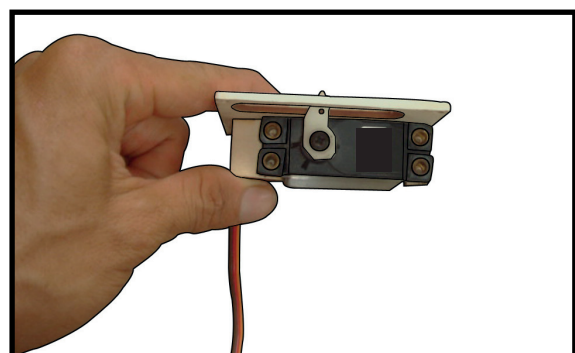

3) Use drill bit in a pin vise to drill the mouting holes in the blocks.

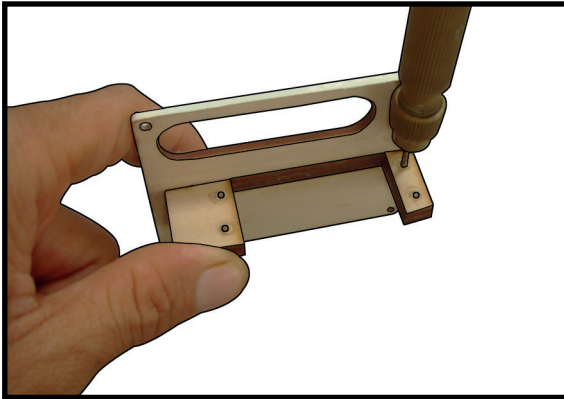

4) Apply 2-3 drops of thin C/A to each of the mounting holes. Allow the C/A to cure without using accelerator.

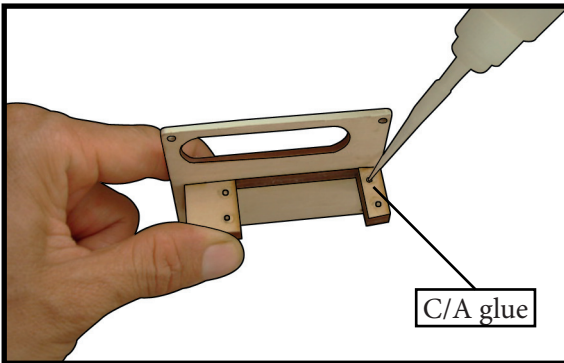

5) Use dental floss to secure the connection so they cannot become unplugged.

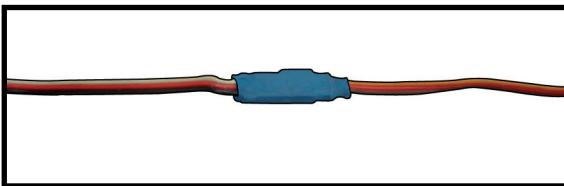

6) Secure the servo to the aileron hatch using Phillips screwdriver and the screws provided with the servo.

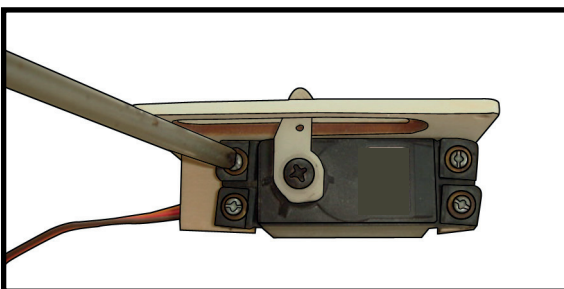

7) Apply 1-2 drops of thin C/A to each of the mounting tabs. Allow the C/A to cure without using accelerator.

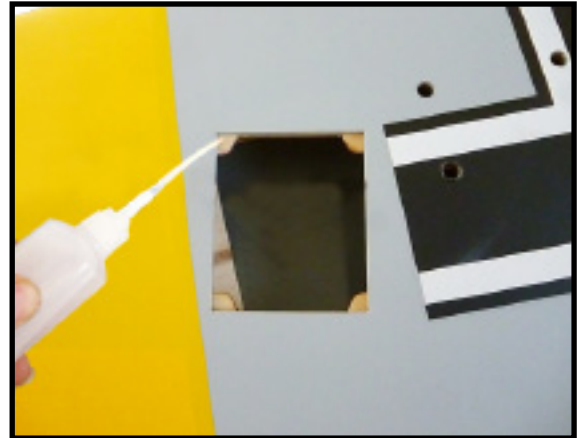

8) Remove the string from the wing at the servo location and use the tape to attach it to the servo extension lead. Pull the lead through the wing and remove the string.

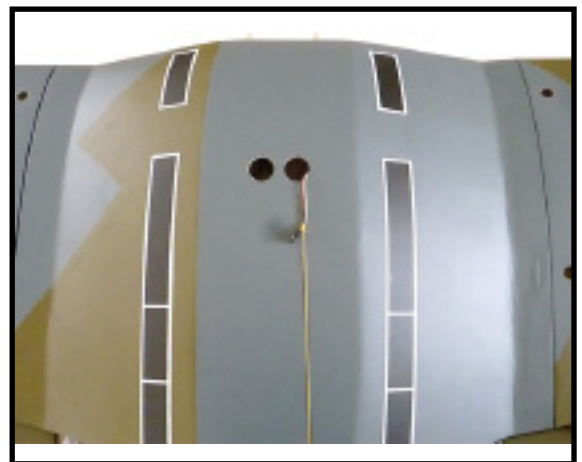
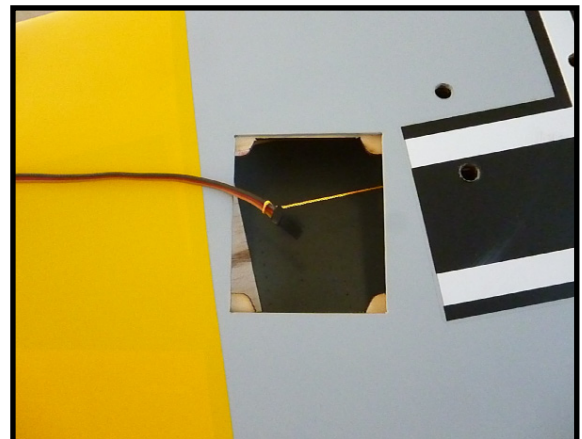



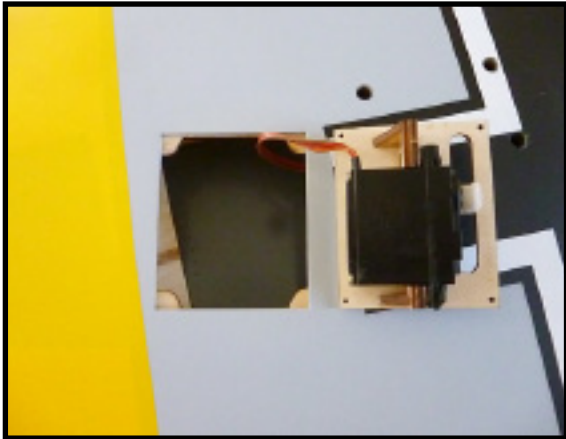

9) Set the aileron hatch in place and use a Phillips screw driver to install it with four wood screws.

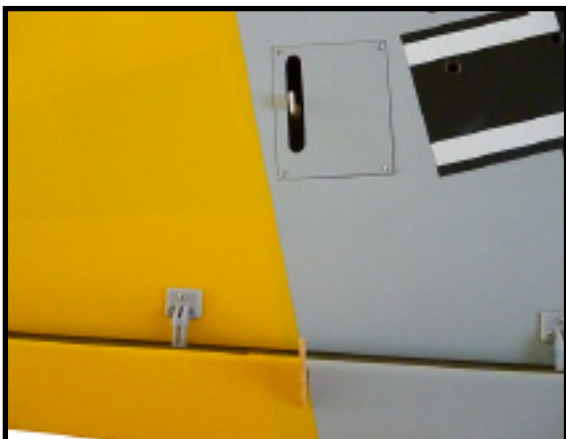
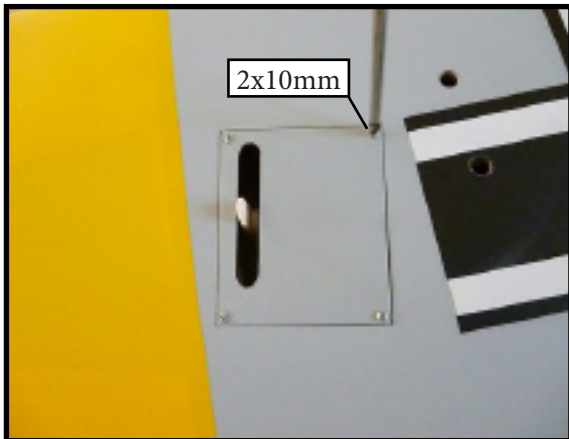

## AILERON PUSHROD INSTALLATION.

Please see below pictures.

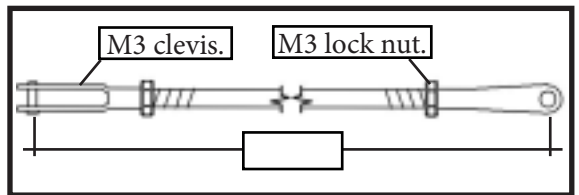
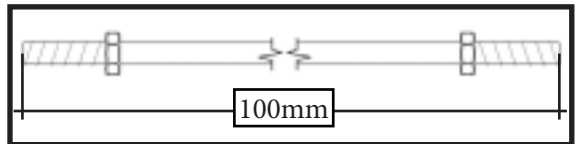
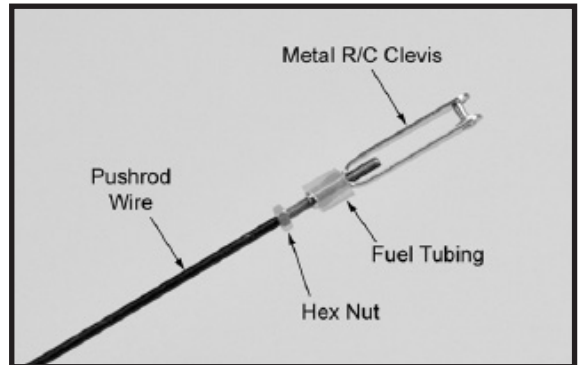

## INSTALLING THE FLAP SERVO.

Repeat the procedure as above for the flap servo.





**INSTALLING THE FLAP PUSHROD.**

Repeat the procedure as aileron push-rod.

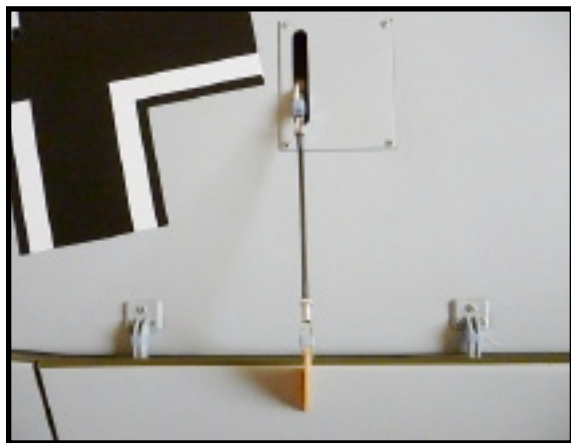
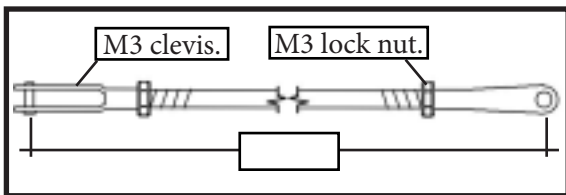
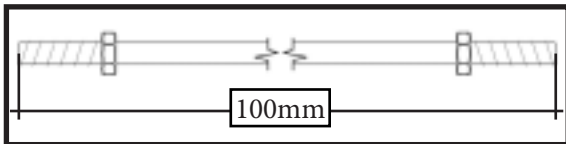

**INSTALLING THE LANDING GEAR.**



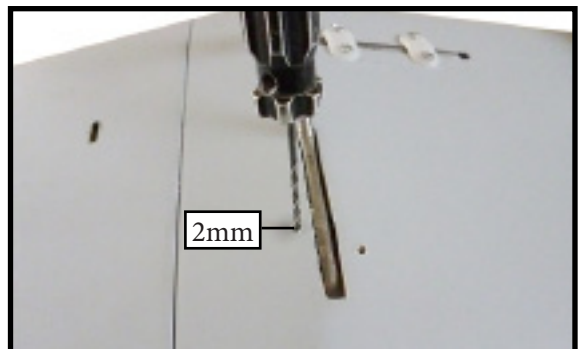
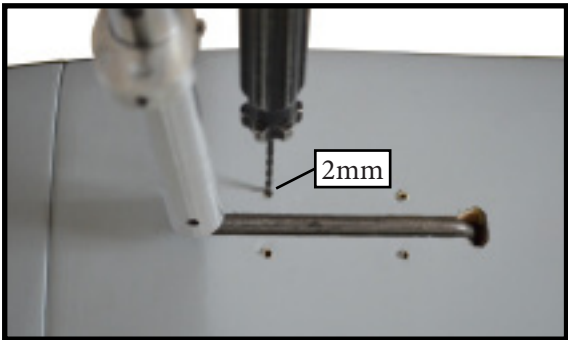
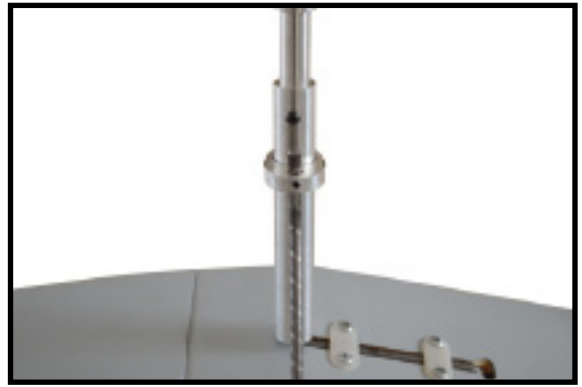
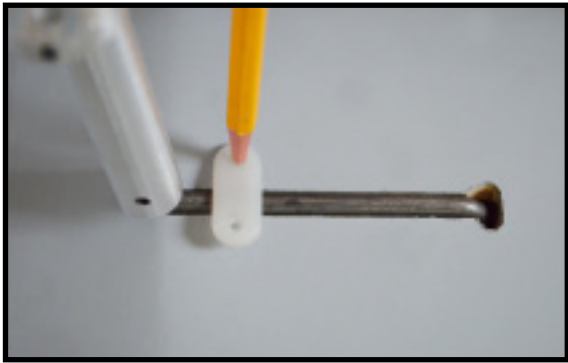

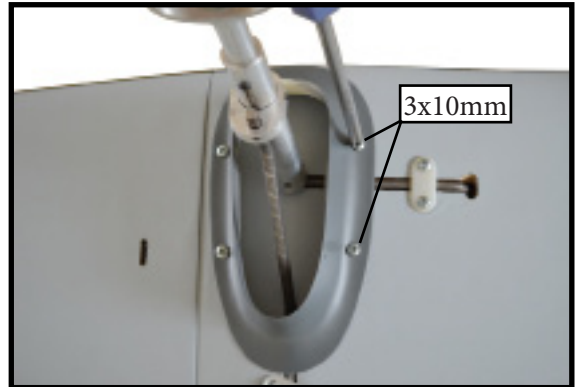
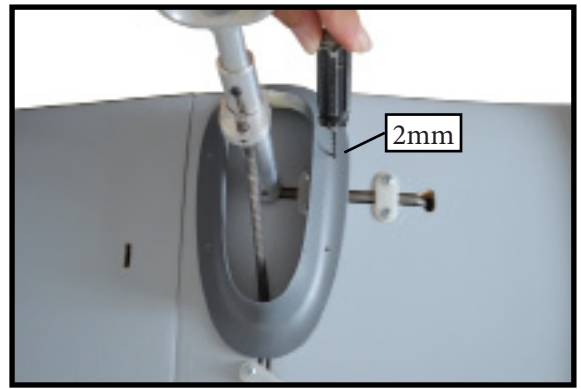
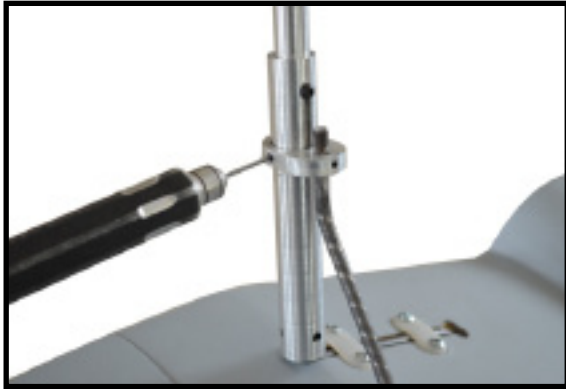

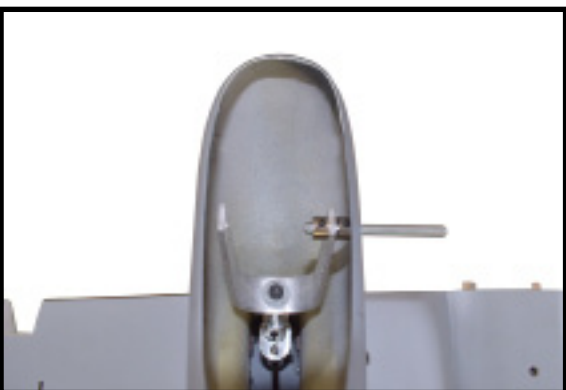
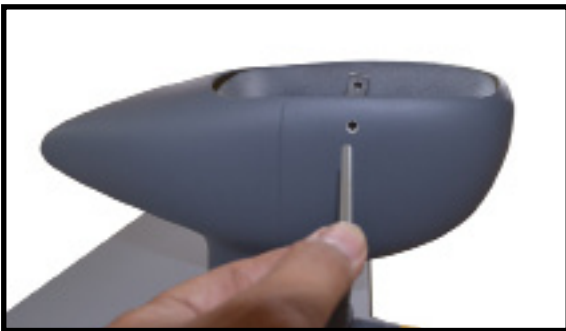
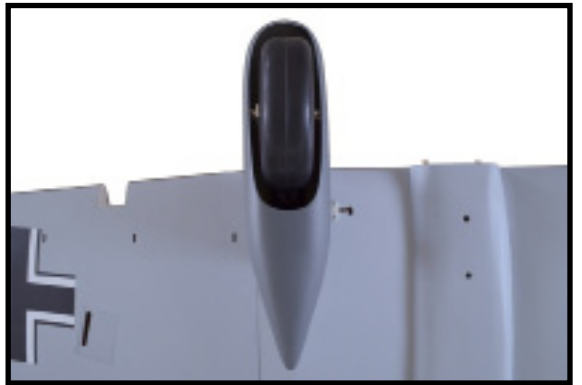
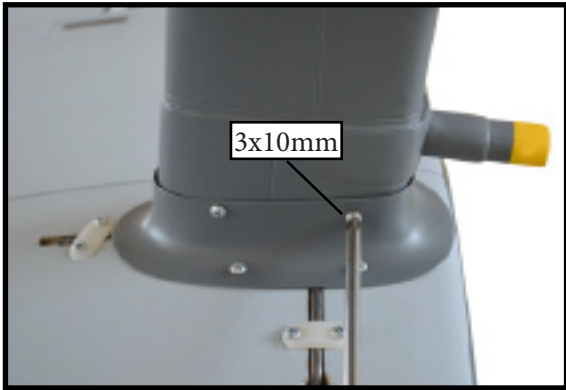
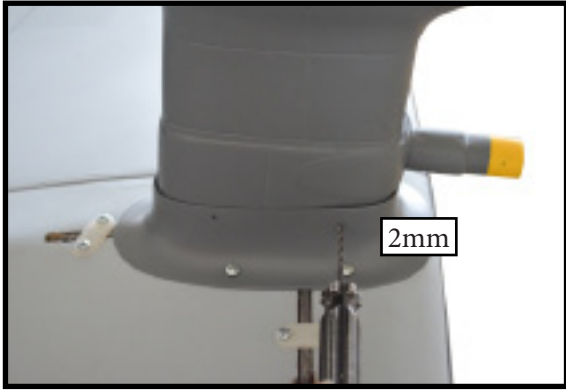

**INSTALLING THE BOMB ON THE WINGS.**

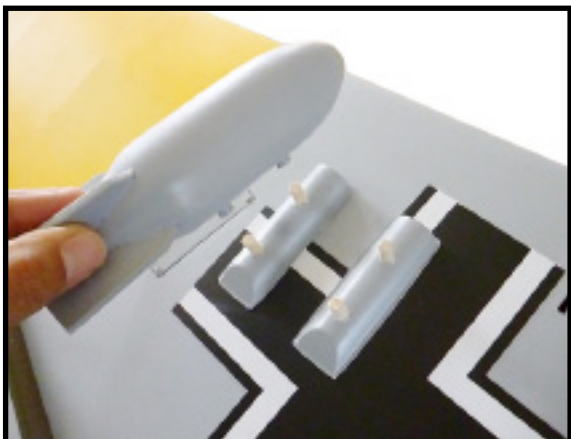
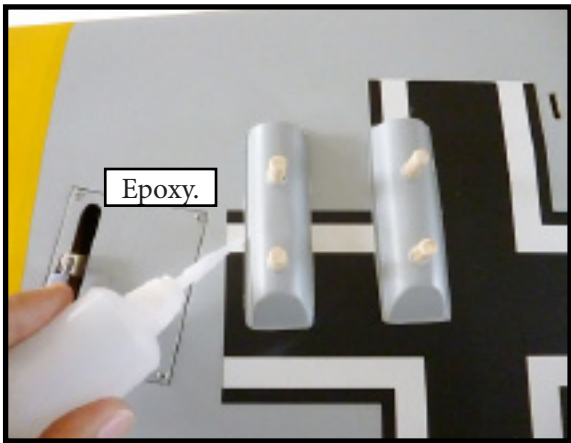
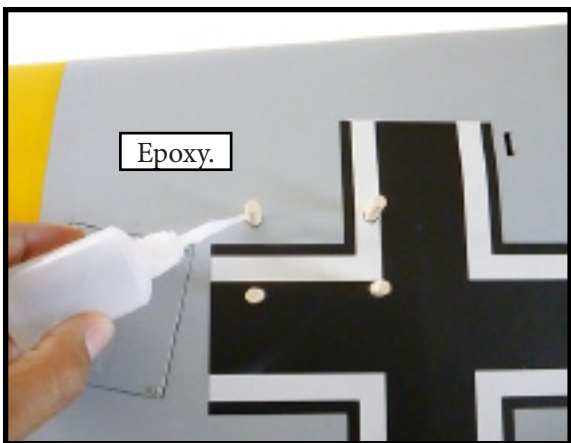
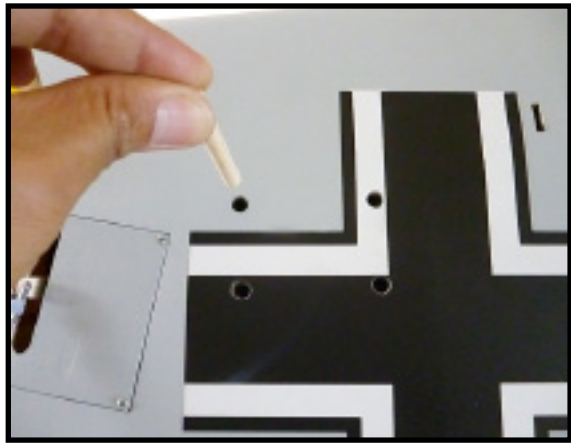
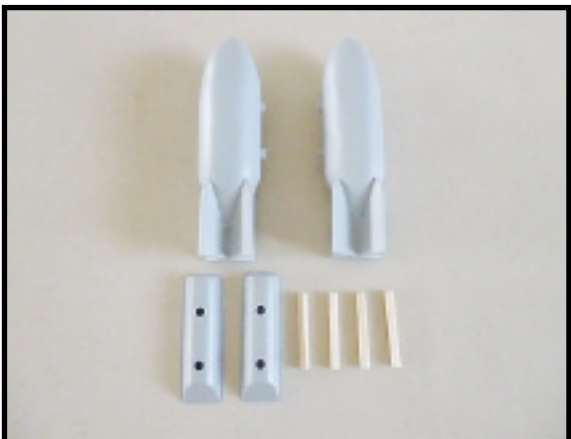
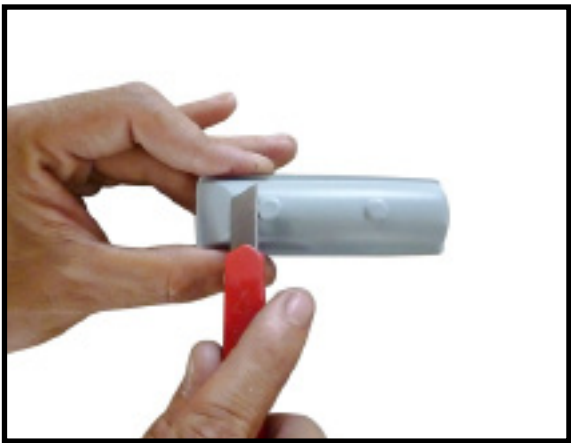
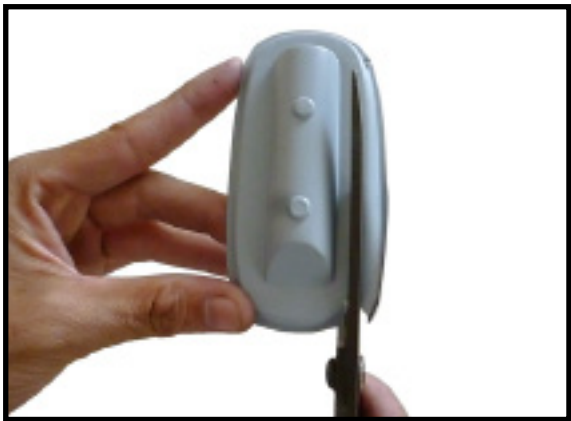

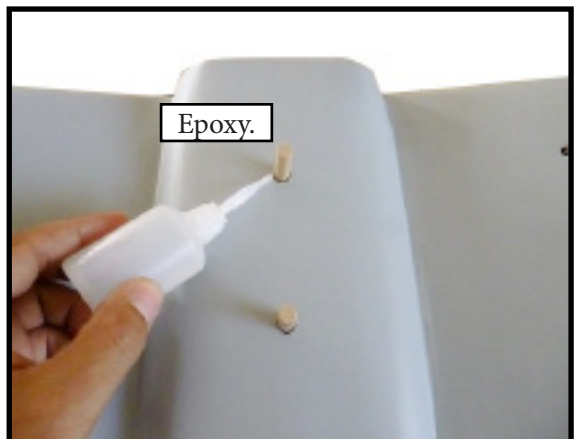
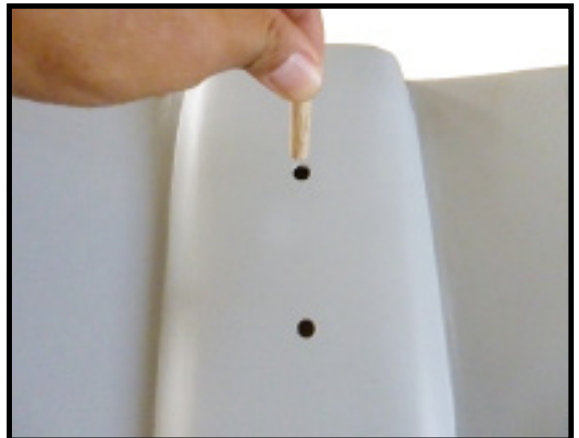
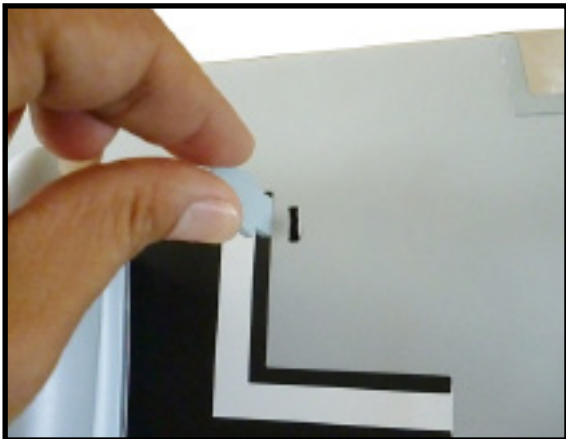
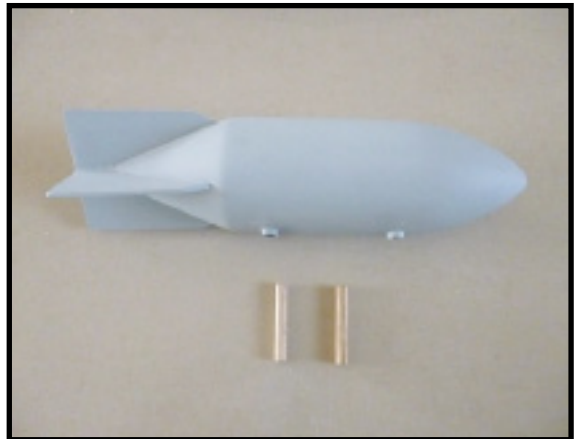
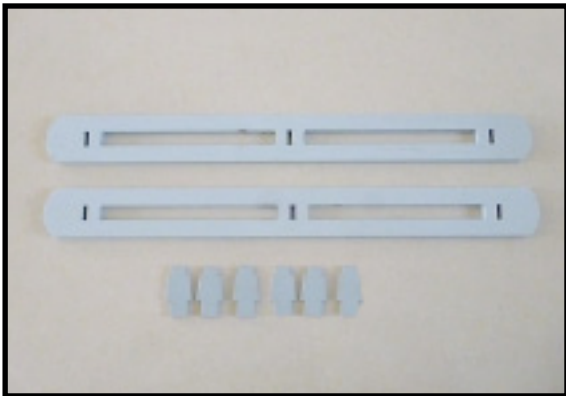
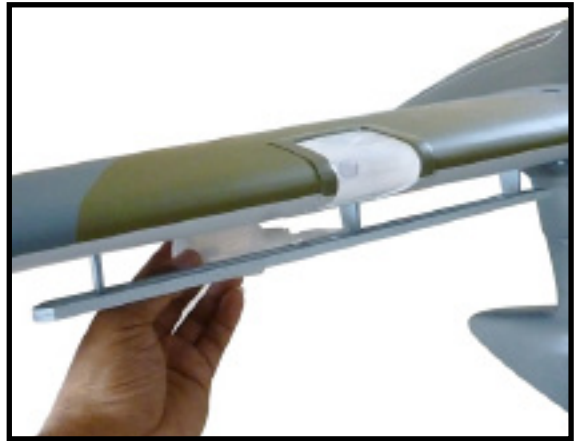

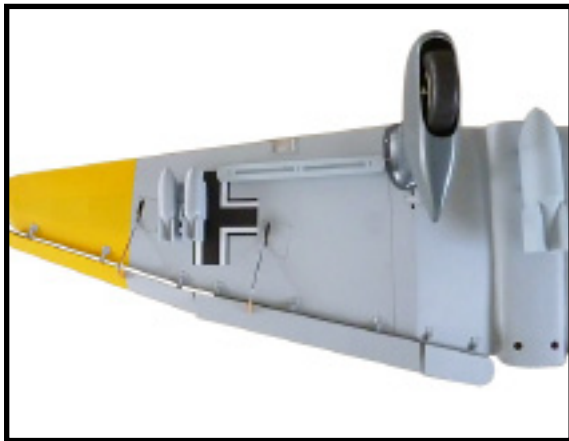
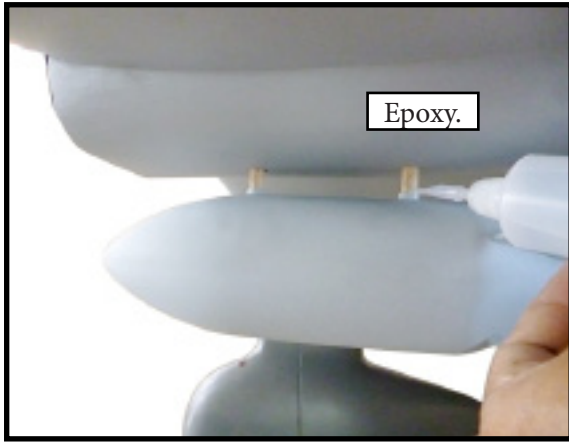

**INSTALLING THE FUSELAGE SERVOS.**

**!** Because the size of servos differ, you may need to adjust the size of the precut opening in the mount. The notch in the sides of the mount allow the servo lead to pass through.

- 1) Install the rubber grommets and brass collets into all servos. Test fit the servo into the fuselage servo mount.
- 2) Secure the servos with the screws provided with your radio system.

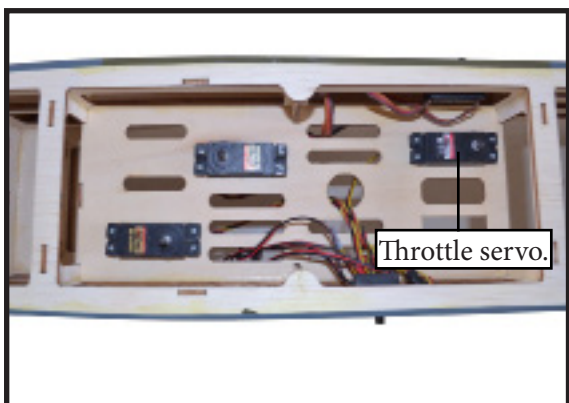

**THROTTLE SERVO ARM INSTALLATION.**

Install adjustable servo connector in the servo arm as same as picture below:

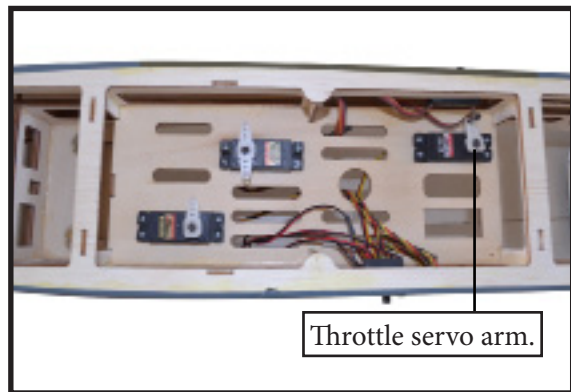
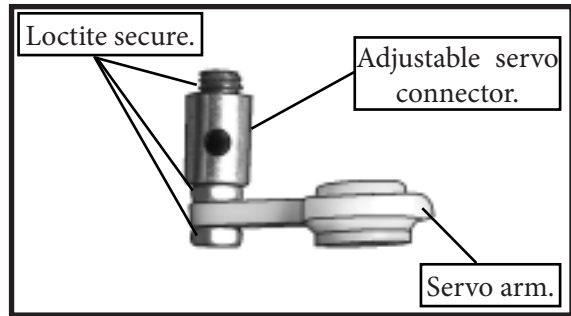

**INSTALLING THE RECEIVER SWITCH.**

Install the switch into the precut hole in the side, in the fuselage.

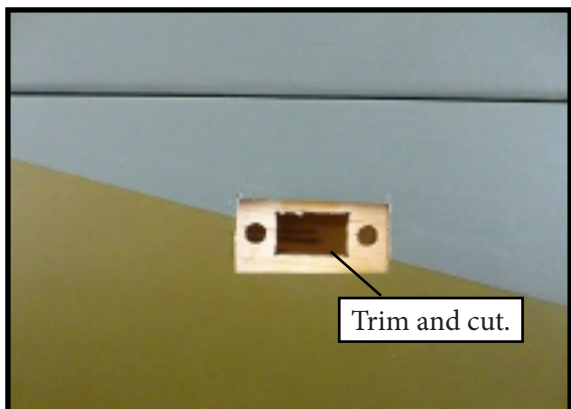
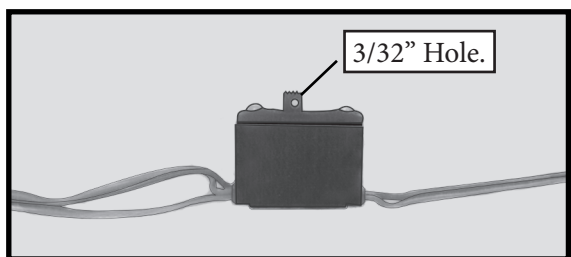



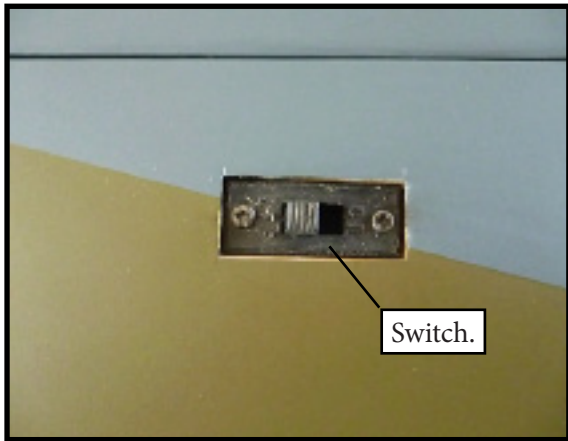

**INSTALLING THE ENGINE SWITCH.**

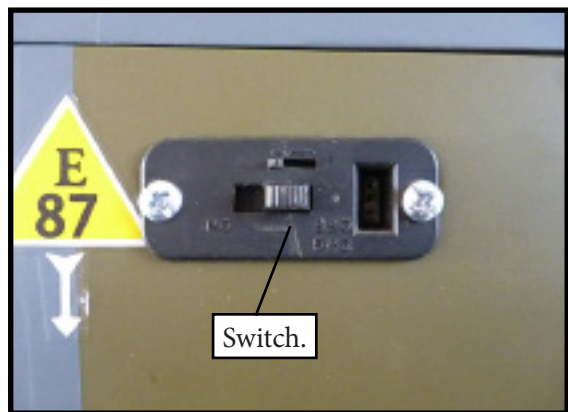
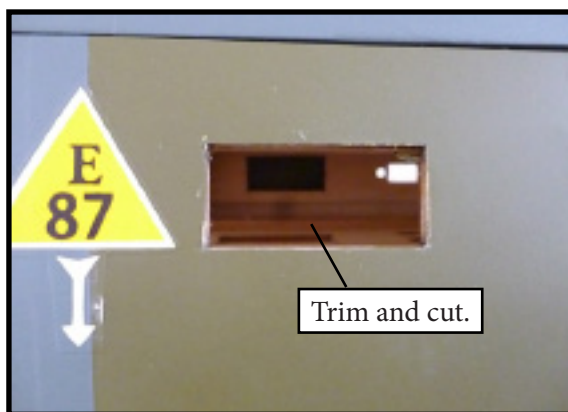

**INSTALLING THE STOPPER ASSEMBLY.**

1) Using a modeling knife, carefully cut off the rear portion of one of the 3 nylon tubes leaving 1/2" protruding from the rear of the stopper. This will be the fuel pick up tube.

2) Using a modeling knife, cut one length of silicon fuel line. Connect one end of the line to the weighted fuel pick up and the other end to the nylon pick up tube.

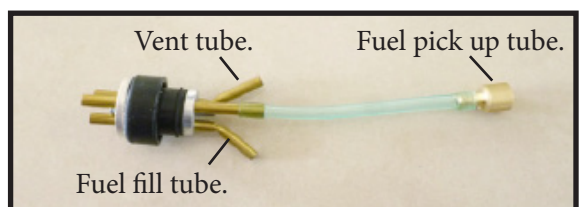
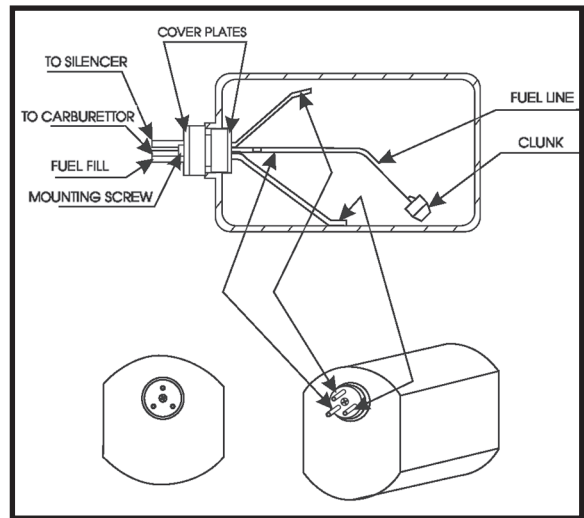

3) Carefully bend the second tube up at a 45° angle. This tube is the vent tube.

4) Test fit the stopper assembly into the tank. It may be necessary to remove some of the flashing around the tank opening using a modeling knife. If flashing is present, make sure none falls into the tank.

5) With the stopper assembly in place, the weighted pick-up should rest away from the rear of the tank and move freely inside the tank. The top of the vent tube should rest just below the top of the tank. It should not touch the top of the tank.

6) When satisfied with the alignment of the stopper assembly tighten the 3 x 20mm machine screw until the rubber stopper expands and seals the tank opening. Do not over-tighten the assembly as this could cause the tank to split.

**FUEL TANK INSTALLATION.**

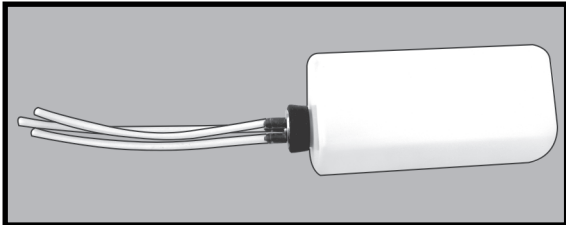

**!** *You should mark which tube is the vent and which is the fuel pickup when you attach fuel tubing to the tubes in the stopper. Once the tank is installed inside the fuselage, it may be difficult to determine which is which.*

7) Slide the fuel tank into the fuselage. Guide the lines from the tank through the hole in the firewall.

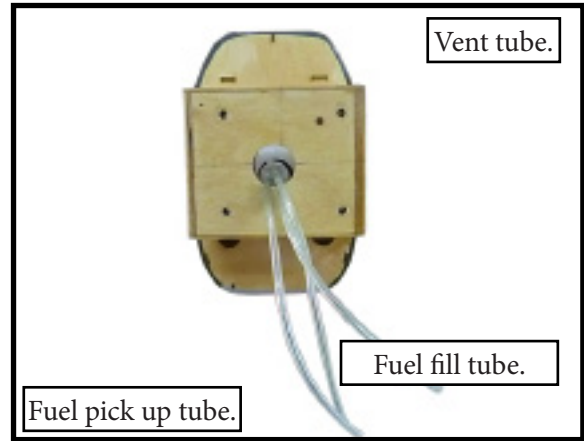
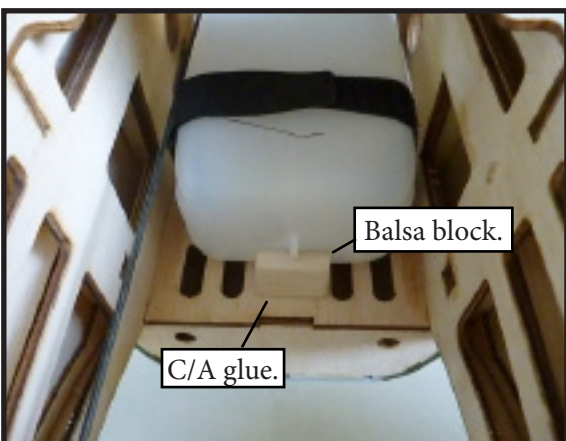

8) Connect the lines from the tank to the engine and muffler. The vent line will connect to the muffler and the line from the clunk to the carburetor.

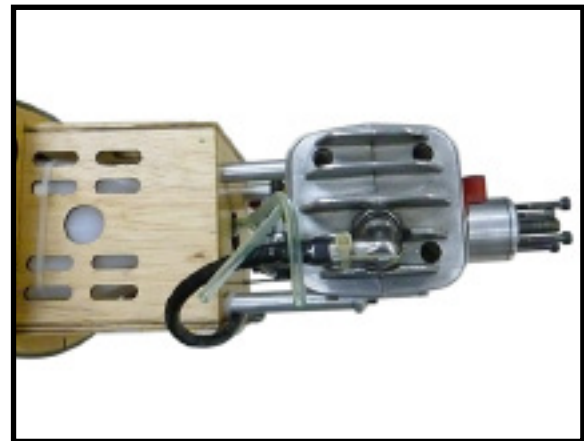

**!** Blow through one of the lines to ensure the fuel lines have not become kinked inside the fuel tank compartment. Air should flow through easily.

**MOUNTING THE ENGINE**

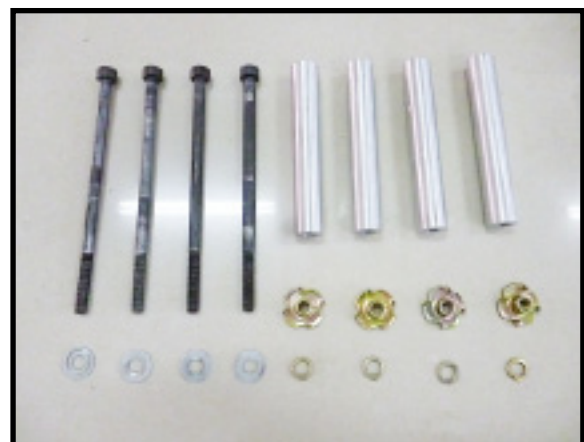

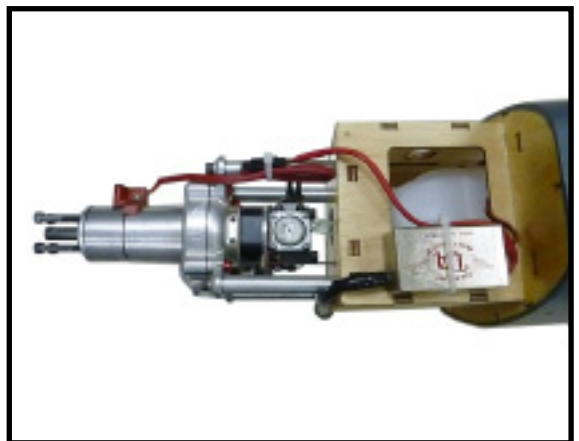
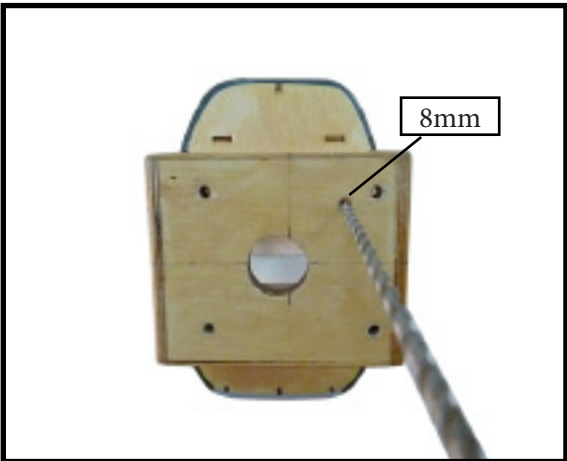
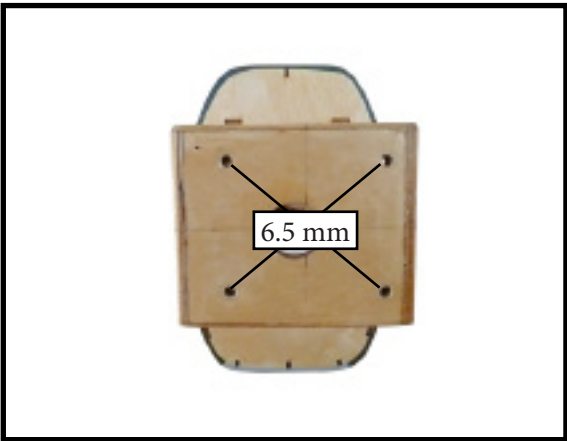
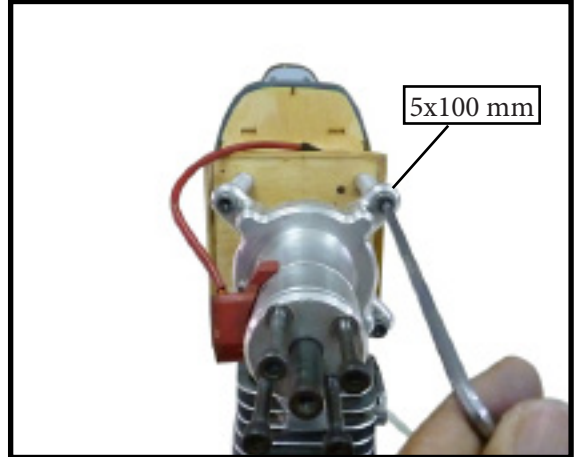
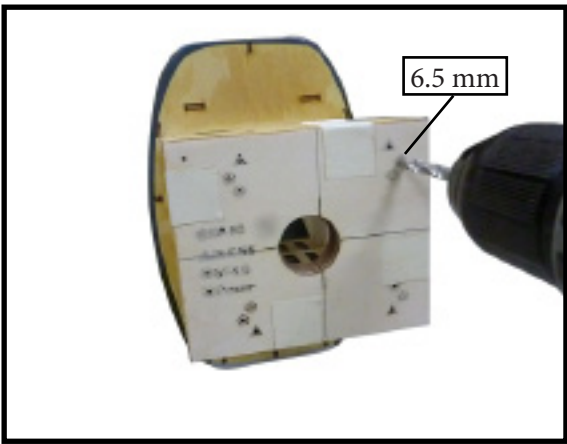
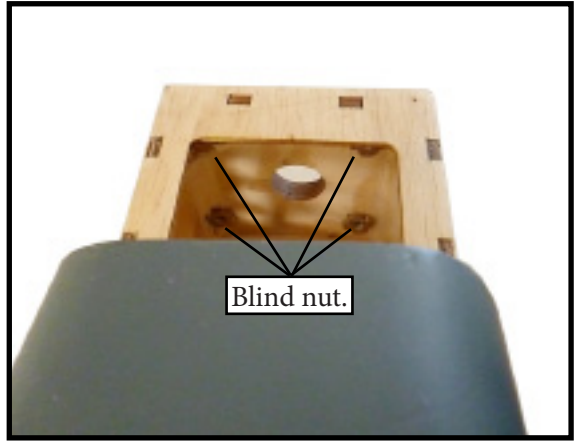
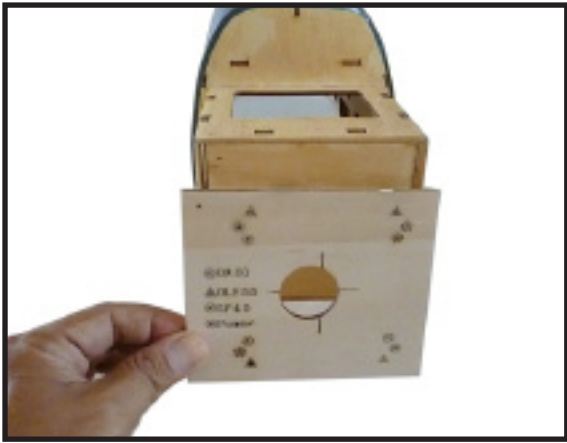

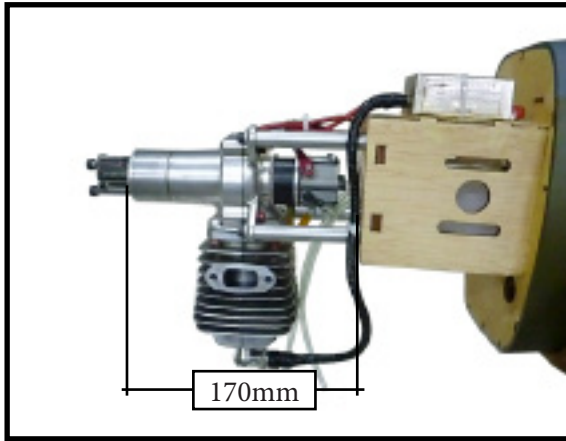

1) Reinstall the servo horn by sliding the connector over the pushrod wire. Center the throttle stick and trim and install the servo horn perpendicular to the servo center line.

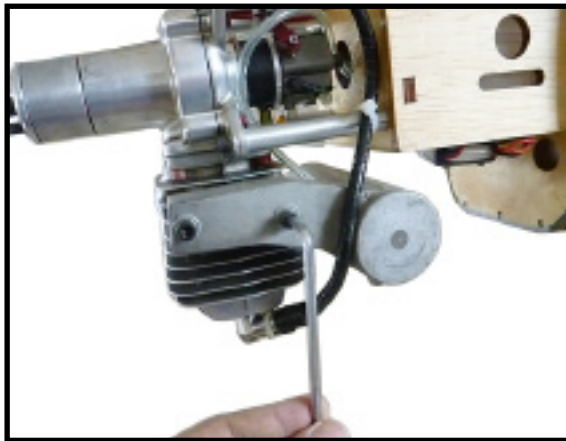
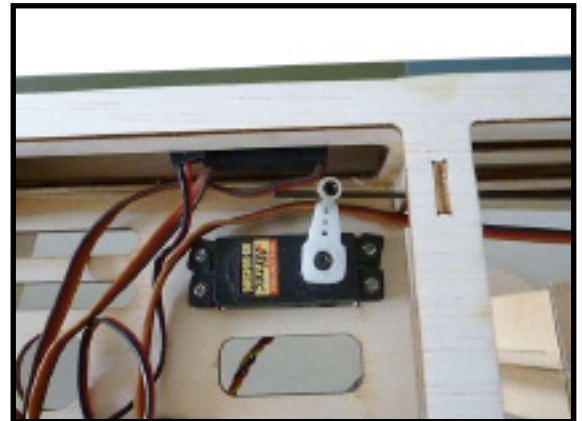
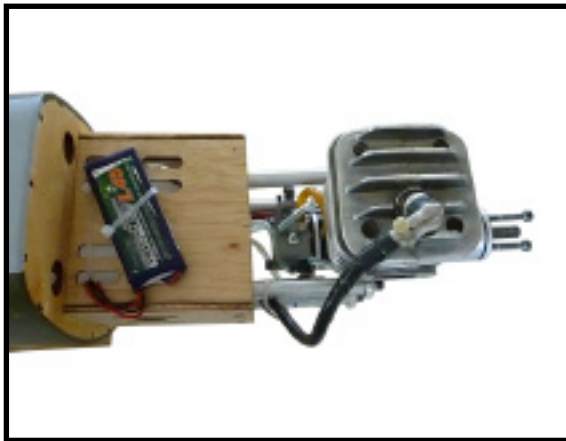

2) Move the throttle stick to the closed position and move the carburetor to closed. Use a 2.5mm hex wrench to tighten the screw that secures the throttle pushrod wire. Make sure to use threadlock on the screw so it does not vibrate loose.

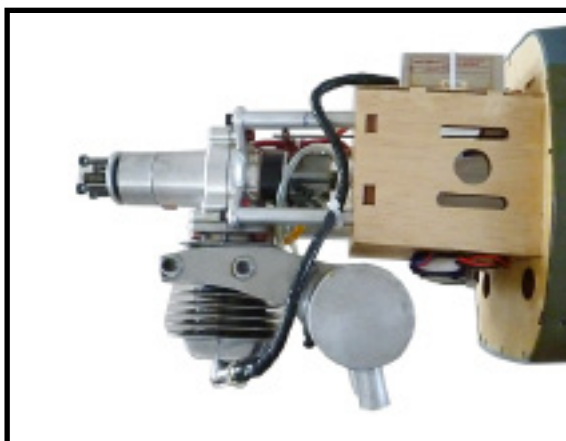

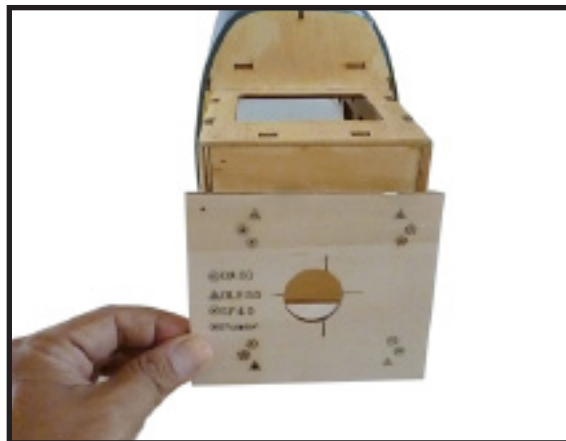
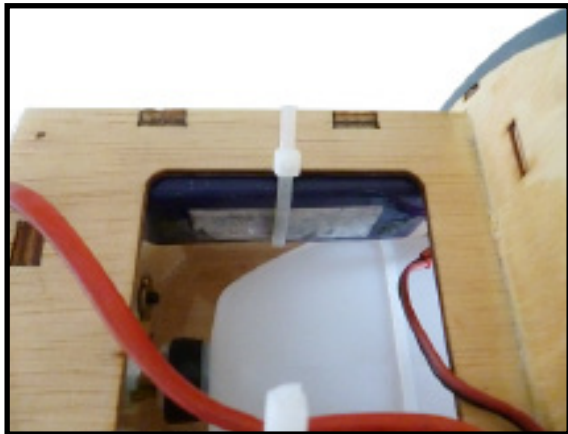

**ELECTRIC POWER CONVERSION.**

1) Locate the items necessary to install the electric power conversion included with your model.

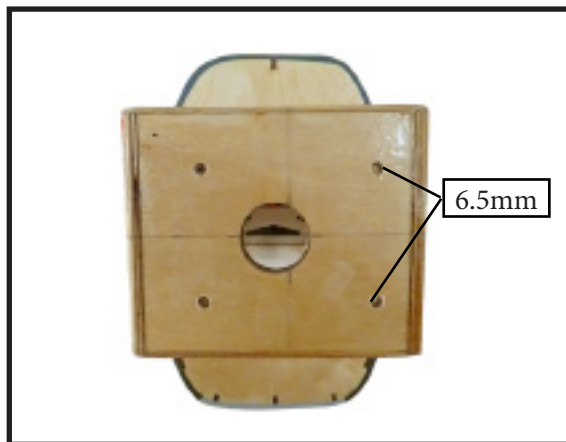
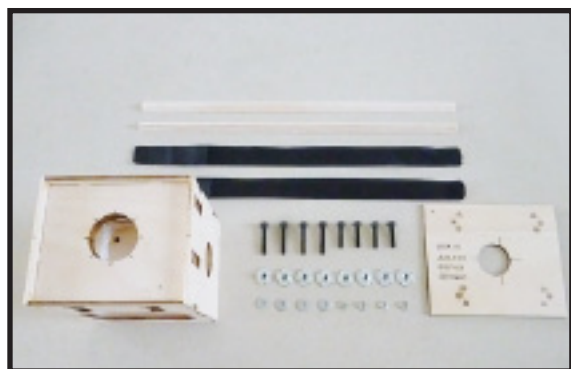
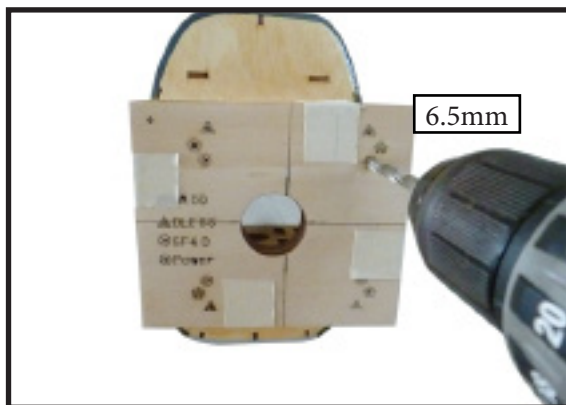

2) Recommend the items necessary to install the electric power conversion parts included with your model.

- **Motor: 360 - 6000 Watt**
- **Propeller: 24x10 ~ 25x12**
- **ESC: 160A- 200A**
- **Lipo: 12S**

3) Attach the electric motor box to the firewall suitable with the cross lines drawn on the electric motor box and firewall. Using M5x25mm to secure the motor box to the firewall. Please see pictures below.



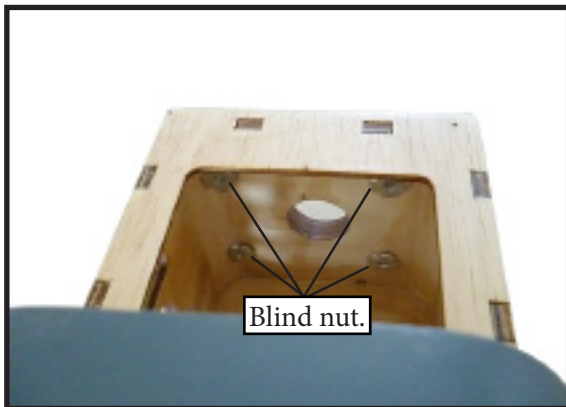
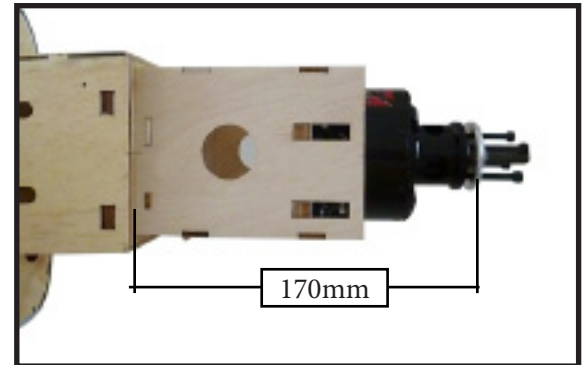
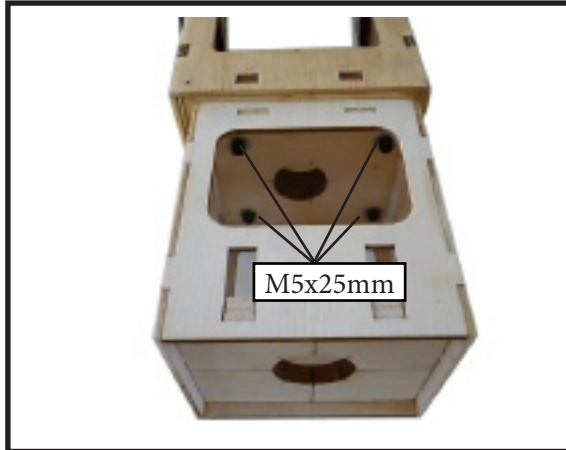
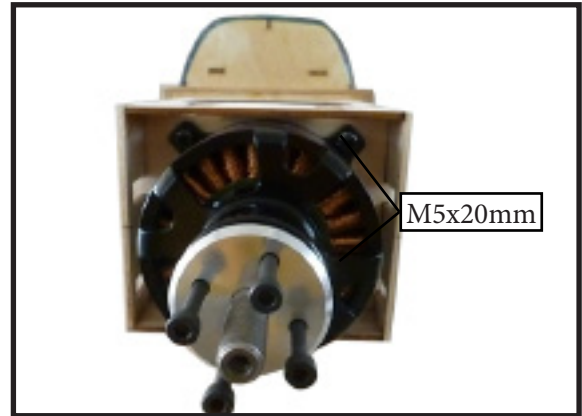
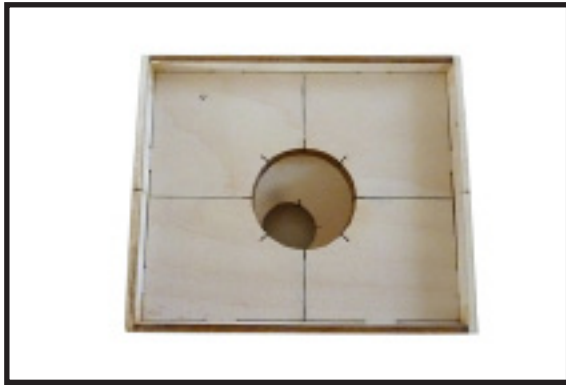

4) Attach the motor to the front of the electric motor box using four 4mm blind nut, four M5x20mm hex head bolts to secure the motor. Please see picture shown.

5) Attach the speed control to the side of the motor box using two-sided tape and tie wraps. Connect the appropriate leads from the speed control to the motor. Make sure the leads will not interfere with the operation of the motor.

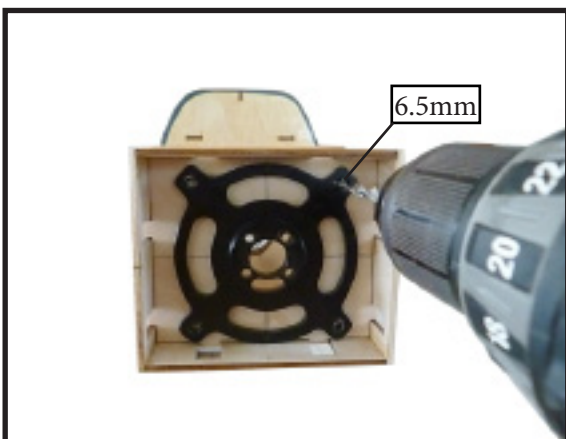

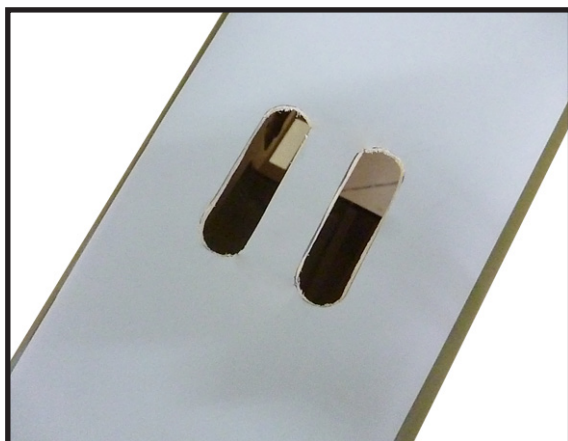
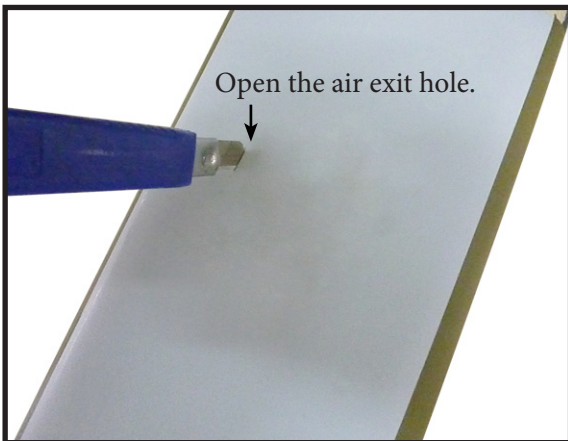
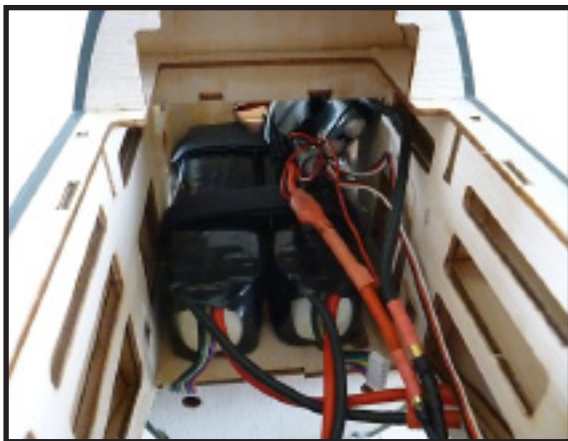

## COWLING.

1) Tape the cowl to the fuselage using low-tack tape.

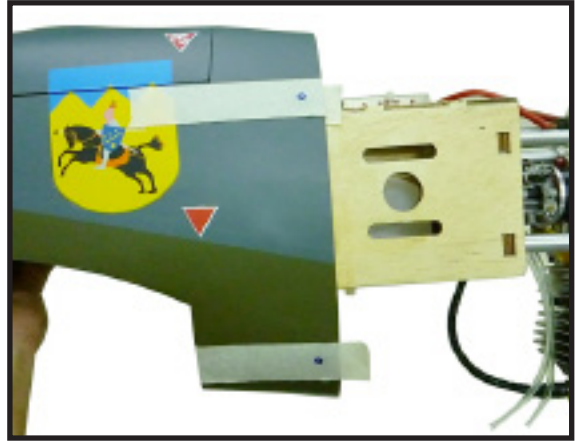

2) Use a drill and drill bit to drill the holes for the cowl mounting screws. Make sure the cowl position is correct before drilling each hole.



3) Slide the muffler screws through the engine. Place the muffler extension and gaskets included with the engine on the screws. Be careful when mounting the cowl so the screws and extension remain in position until the muffler can be attached.

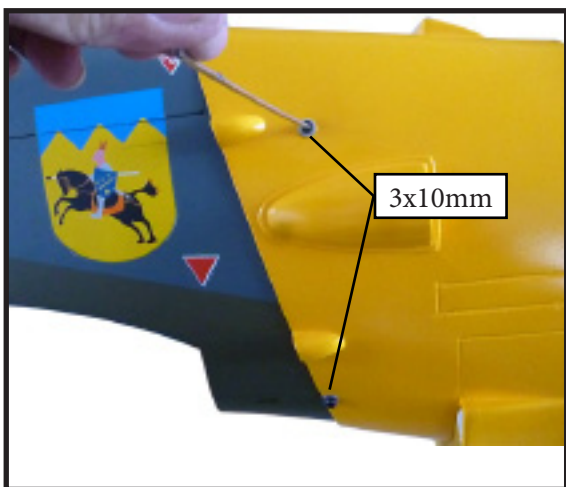
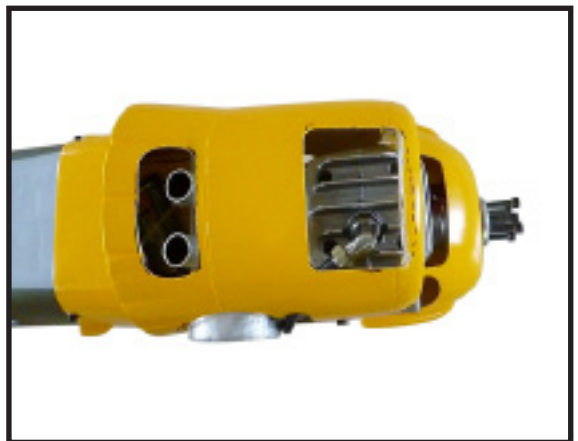
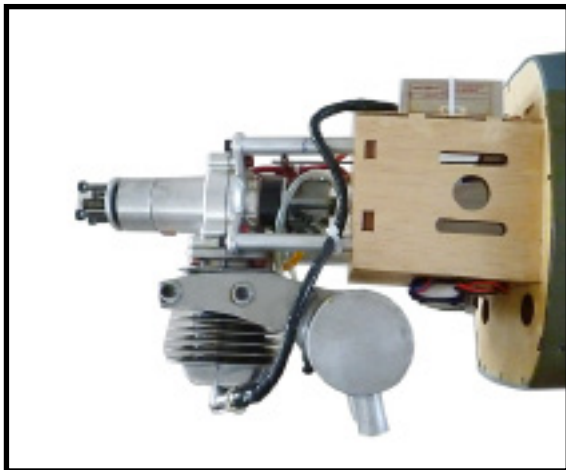



## INSTALLING THE SPINNER.



⚠ The propeller should not touch any part of the spinner cone. If it does, use a sharp modeling knife and carefully trim away the spinner cone where the propeller comes in contact with it.



Insert plastic cover on the cowling.

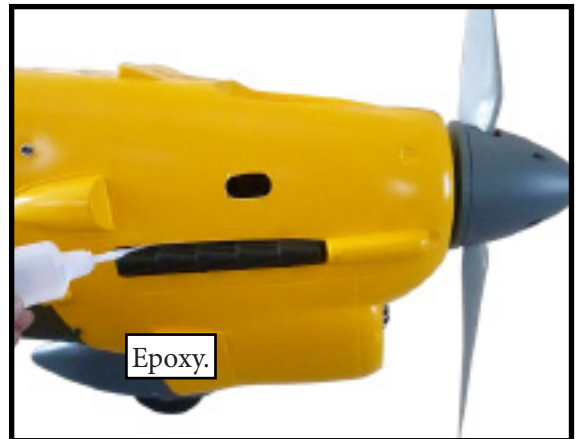

## HINGING THE ELEVATOR.

Glue the elevator hinges in place using the same techniques as below pictures.

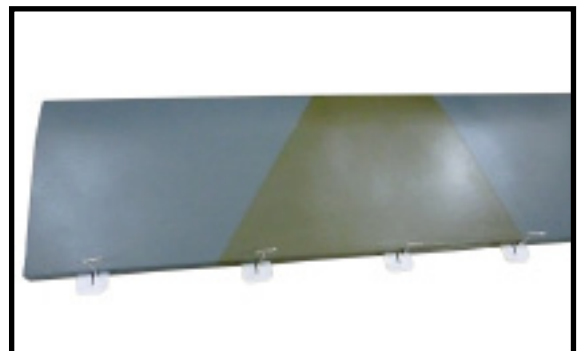

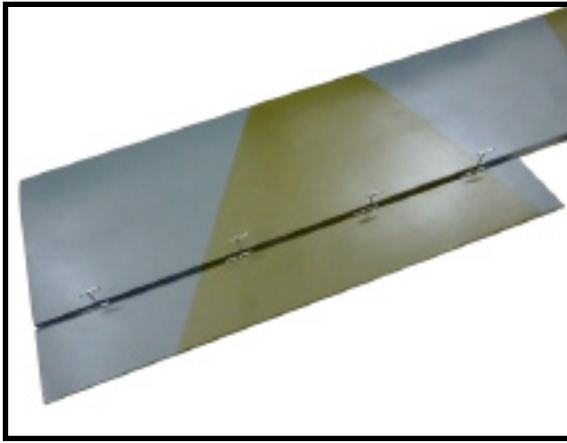

**INSTALL ELEVATOR CONTROL HORN.**

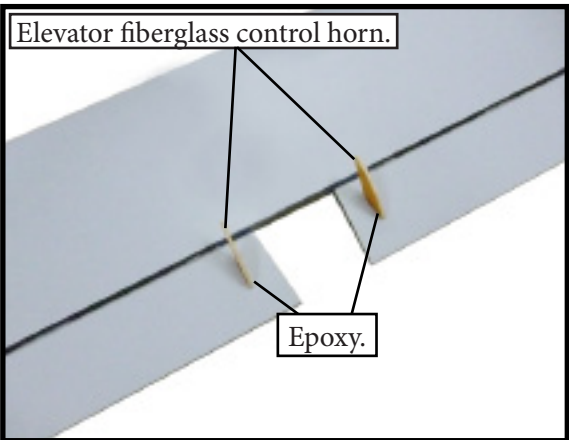
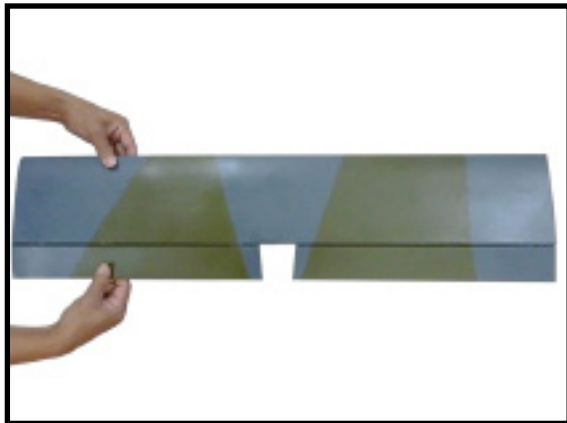
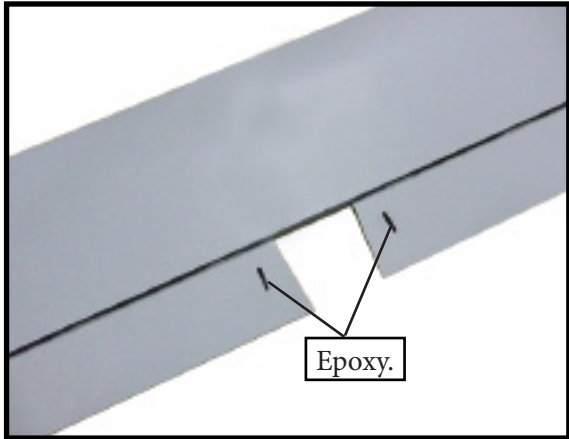
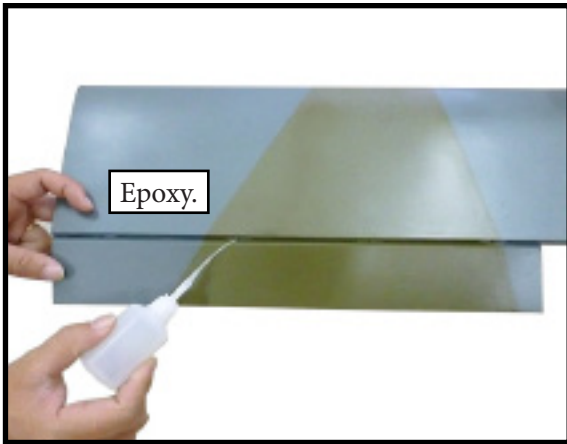
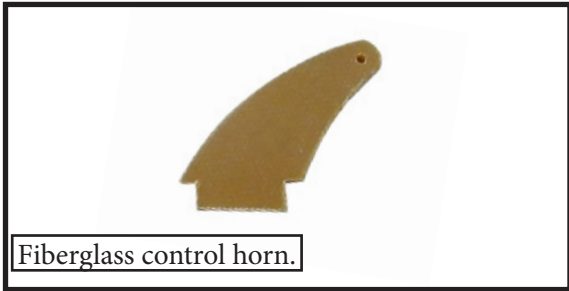

**HINGING THE RUDDER.**

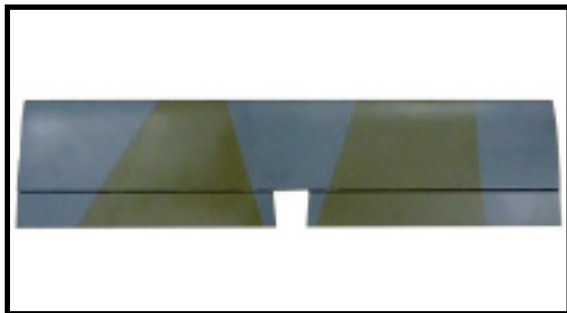

Glue the top three rudder hinges in place using the same techniques used to hinge the elevator.  
 The lower hinge will be glued when the fin/rudder assembly is attached to the fuselage.



### INSTALL RUDDER CONTROL HORN.

Repeat steps to install the rudder control horn as same as steps done for elevator.

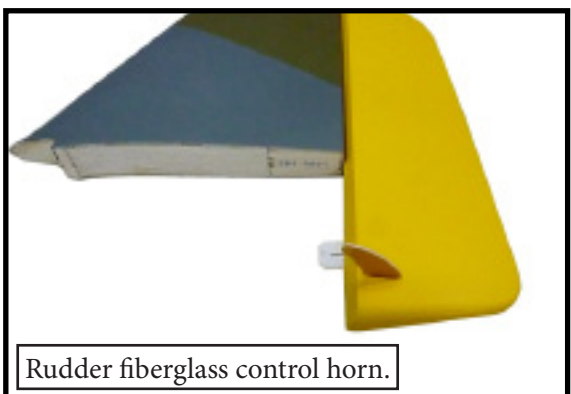
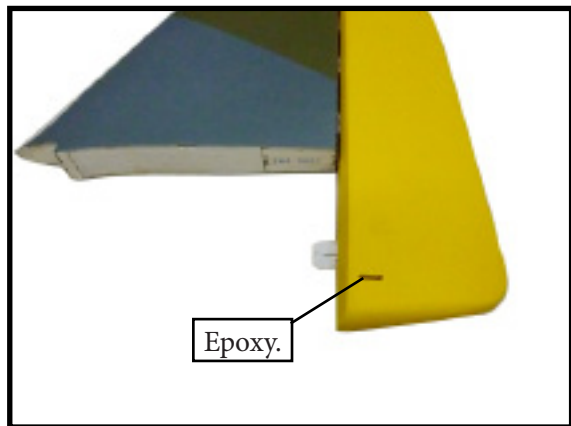

### INSTALLING THE HORIZONTAL STABILIZER.

1) Using a ruler and a pen, locate the centerline of the horizontal stabilizer, at the trailing edge, and place a mark. Use a triangle and extend this mark, from back to front, across the top of the stabilizer. Also extend this mark down the back of the trailing edge of the stabilizer.

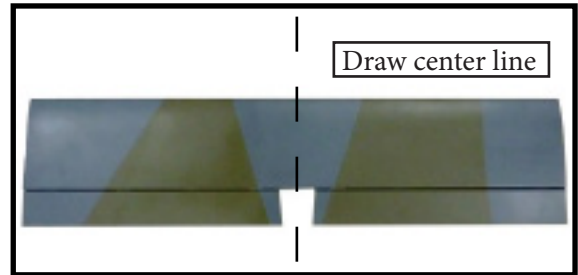

2) Using a modeling knife, carefully remove the covering at mounting slot of horizontal stabilizer ( both side of fuselage).

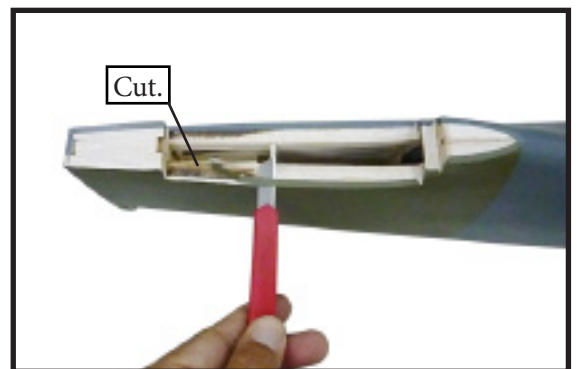

3) Slide the stabilizer into place in the precut slot in the rear of the fuselage. The stabilizer should be pushed firmly against the front of the slot.

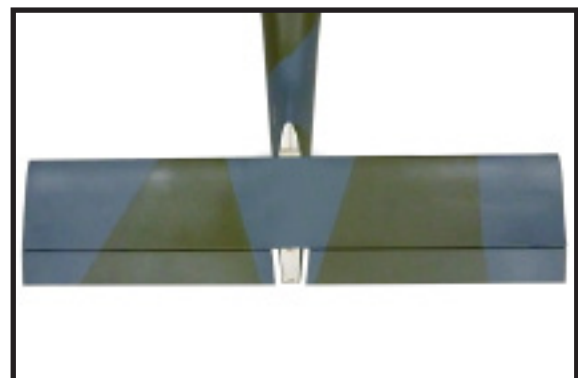

4) With the stabilizer held firmly in place, use a pen and draw lines onto the stabilizer where it and the fuselage sides meet. Do this on both the right and left sides and top and bottom of the stabilizer.

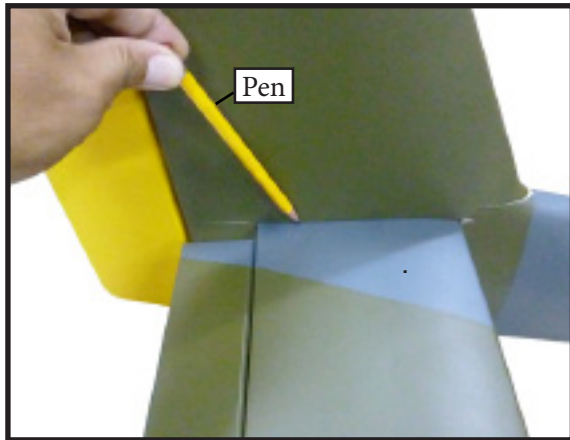

5) Remove the stabilizer. Using the lines you just drew as a guide, carefully remove the covering from between them using a modeling knife.

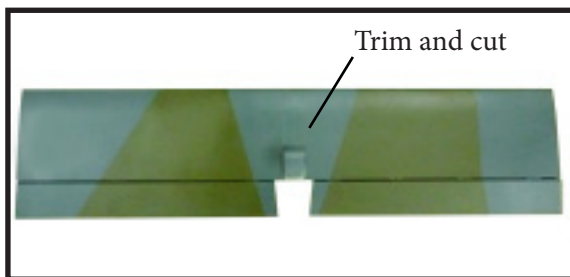

**!** When cutting through the covering to remove it, cut with only enough pressure to only cut through the covering itself. Cutting into the balsa structure may weaken it.

6) Using a modeling knife, carefully remove the covering that overlaps the stabilizer mounting platform sides in the fuselage. Remove the covering from both the top and the bottom of the platform sides.

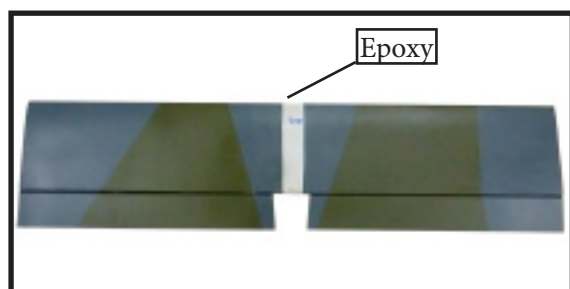

7) When you are sure that everything is aligned correctly, mix up a generous amount of 30 Minute Epoxy. Apply a thin layer to the top and bottom of the stabilizer mounting area and to the stabilizer mounting platform sides in the fuselage. Slide the stabilizer in place and realign. Double check all of your measurements, once more before the epoxy cures. Hold the stabilizer in place with T-pins or masking tape and remove any excess epoxy using a paper towel and rubbing alcohol.

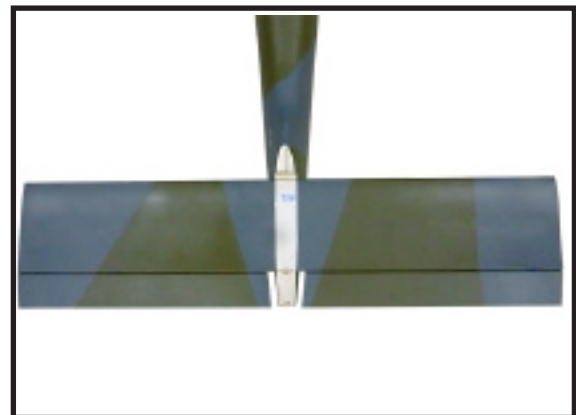
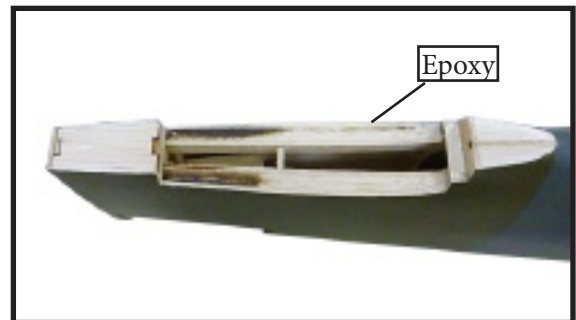

**INSTALLING VERTICAL STABILIZER**

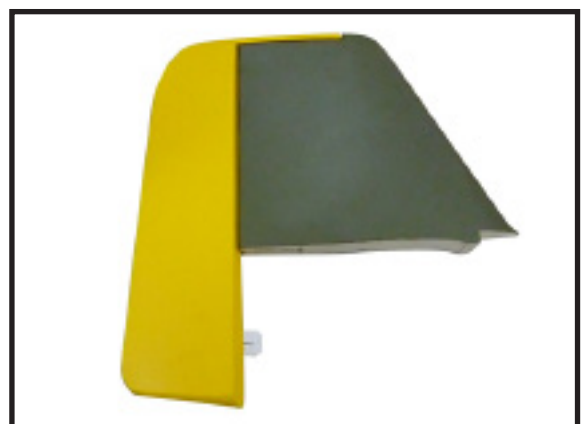

1) Using a modeling knife, remove the covering from over the precut hinge slot cut into the lower rear portion of the fuselage. This slot accepts the lower rudder hinge.

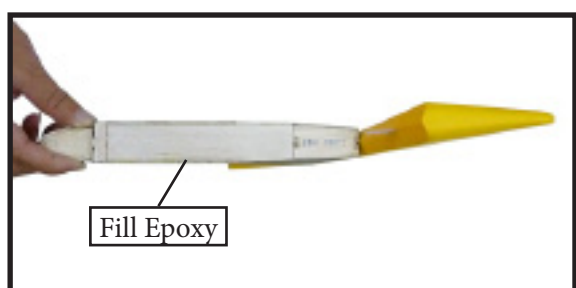
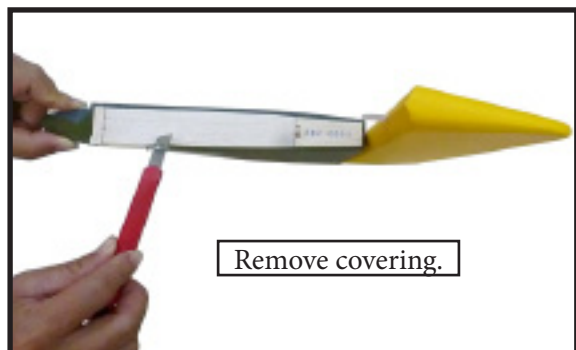

2) Slide the vertical stabilizer into the slot in the top of the fuselage. The rear edge of the stabilizer should be flush with the rear edge of the fuselage and the lower rudder hinge should engage the precut hinge slot in the lower fuselage. The bottom edge of the stabilizer should also be firmly pushed against the top of the horizontal stabilizer.

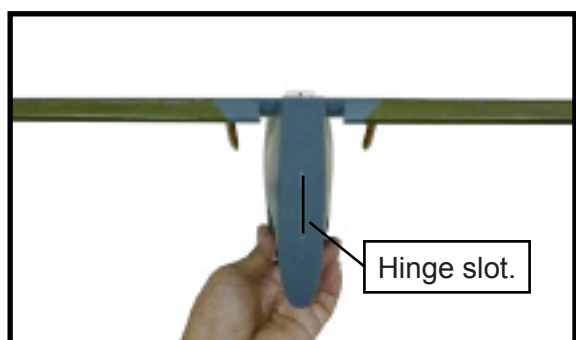

3) While holding the vertical stabilizer firmly in place, use a pen and draw a line on each side of the vertical stabilizer where it meets the top of the fuselage.

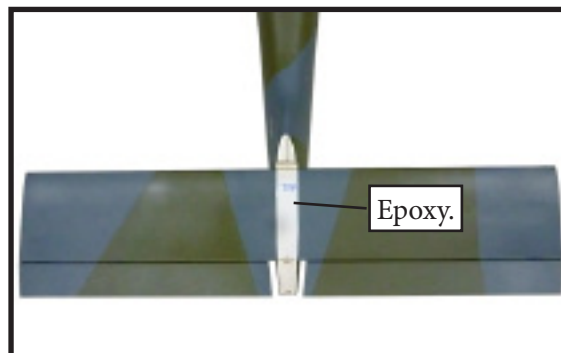

4) Slide the vertical stabilizer back in-place. Using a triangle, check to ensure that the vertical stabilizer is aligned 90° to the horizontal stabilizer.

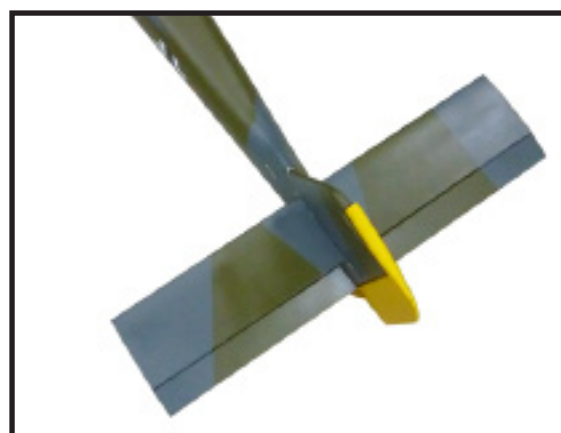
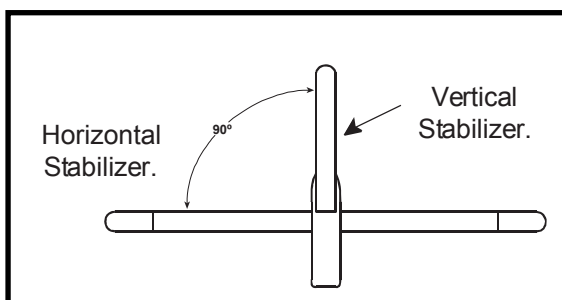

5) When you are sure that everything is aligned correctly, mix up a generous amount of Flash 30 Minute Epoxy. Apply a thin layer to the mounting slot and to bottom of the vertical stabilizer mounting area. Apply epoxy to the bottom and top edges of the filler block and to the lower hinge also. Set the stabilizer in place and realign. Double check all of your measurements once more before the epoxy cures. Hold the stabilizer in place with T-pins or masking tape and remove any excess epoxy using a paper towel and rubbing alcohol. Allow the epoxy to fully cure before proceeding.

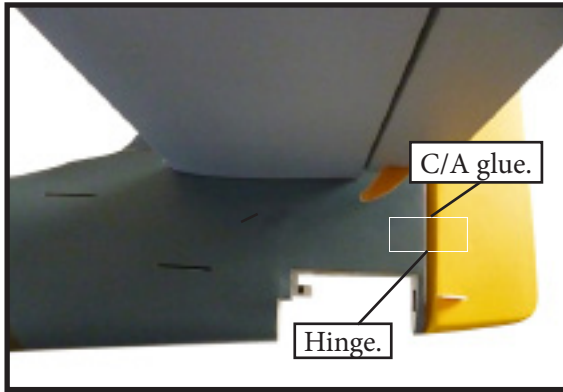

**ELEVATOR PUSHROD INSTALLATION.**

- 1) Install the elevator control horn using the same method as with the aileron control horns.
- 2) Position the elevator control horn on the both side of elevator.

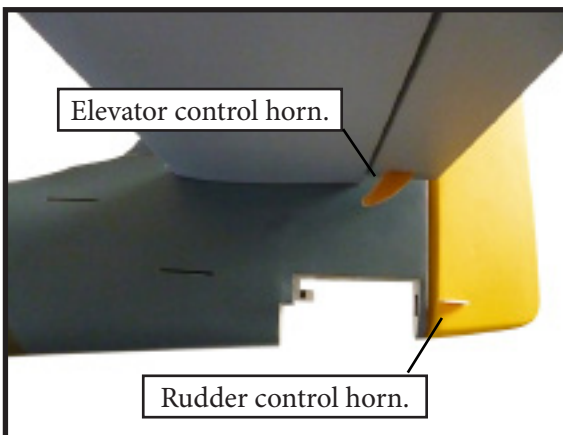
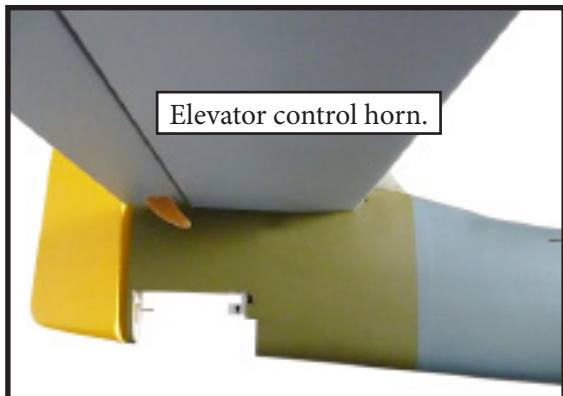

- 3) Thread one clevis and M2 lock nut on to each elevator control rod. Thread the horns on until they are flush with the ends of the control rods.

- 4) Elevator and rudder pushrods assembly as pictures below.

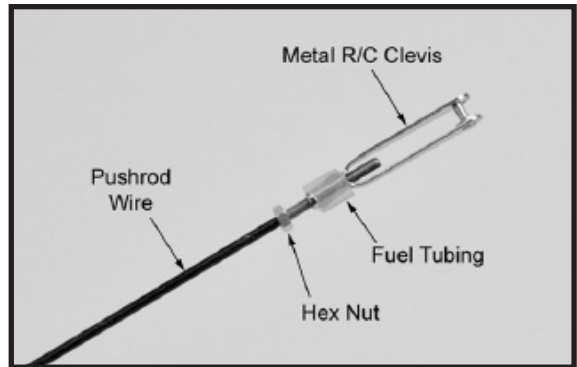

*Elevator pushrod.*

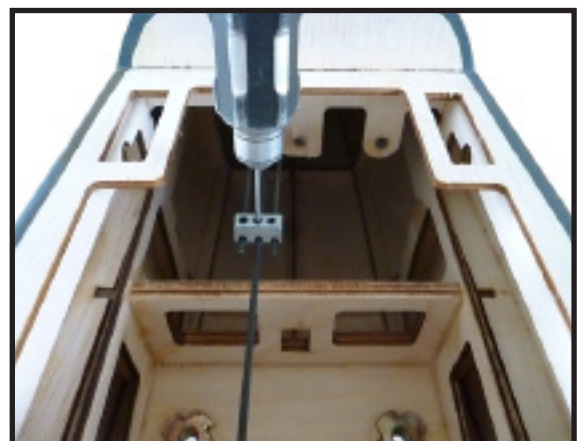
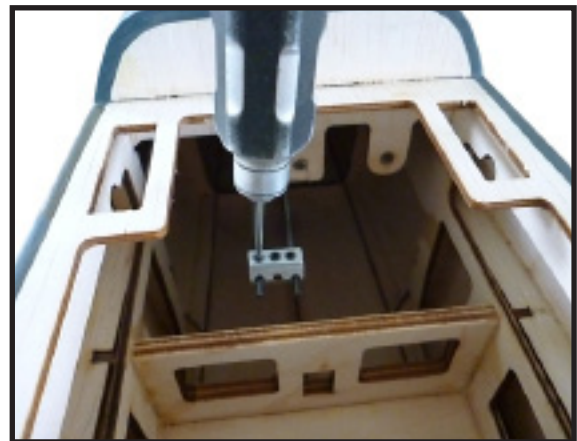
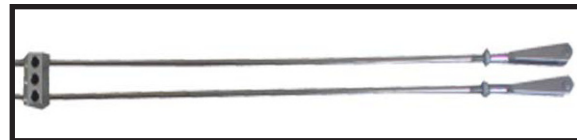
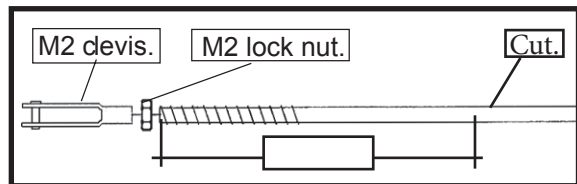

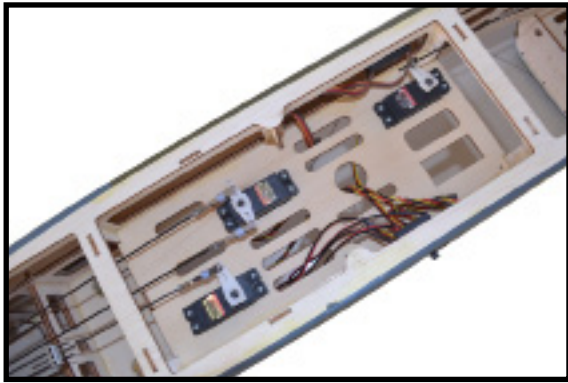

**MOUNTING THE TAIL WHEEL.**

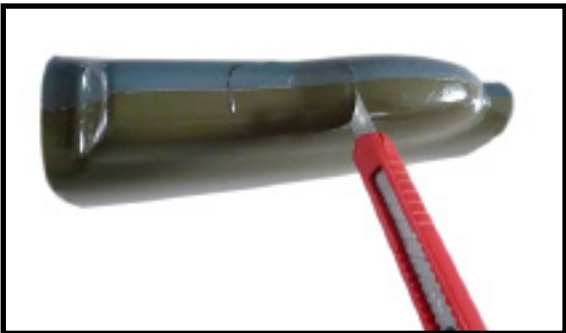
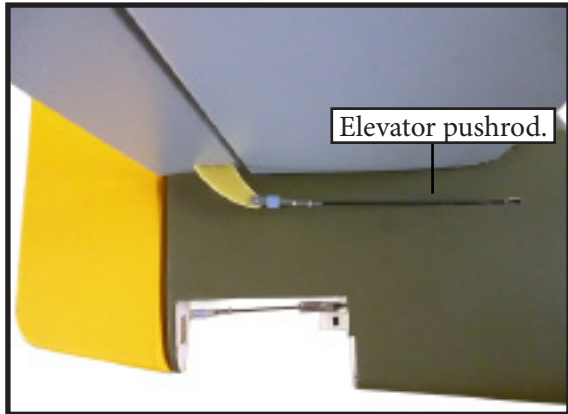

*Rudder pushrod.*

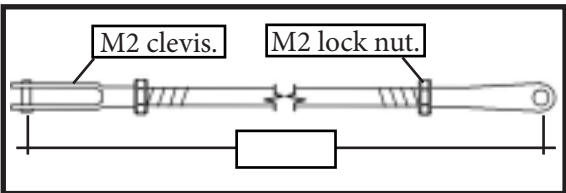
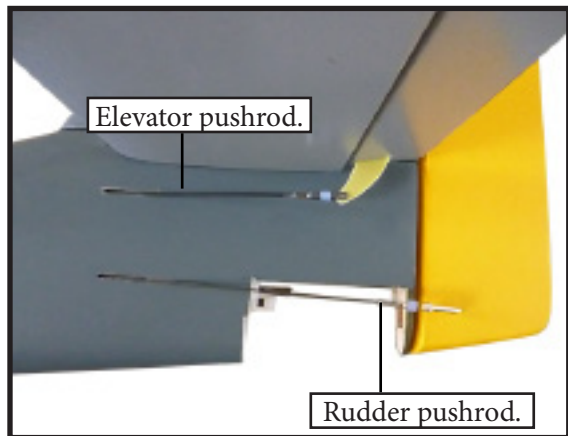
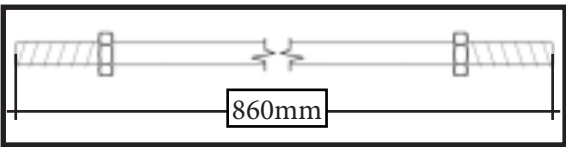
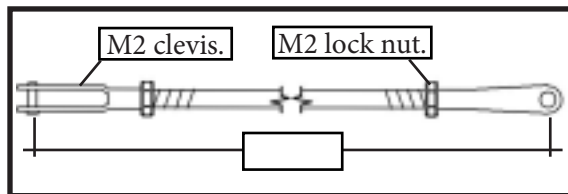
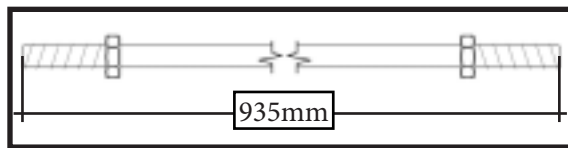

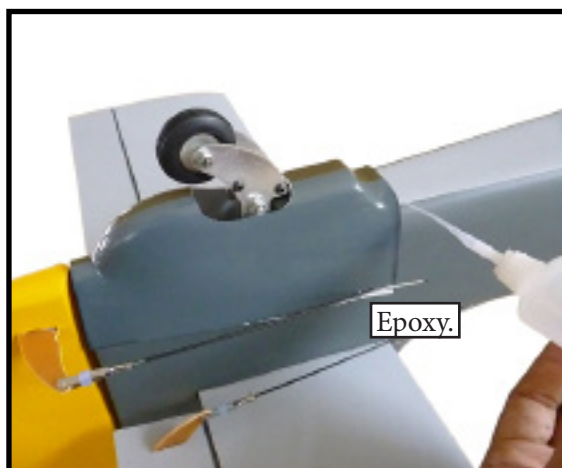
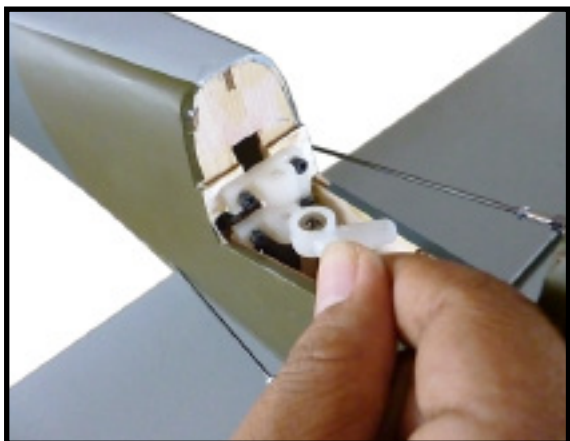
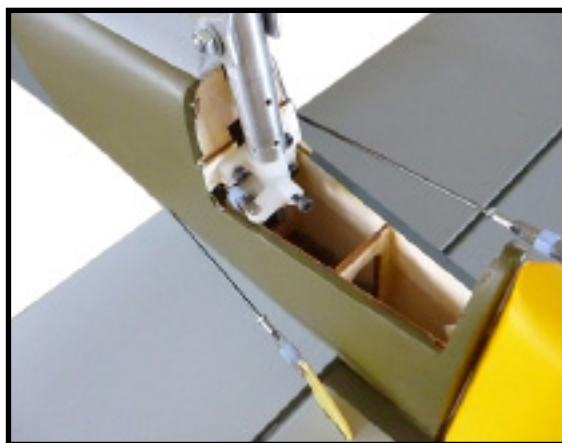
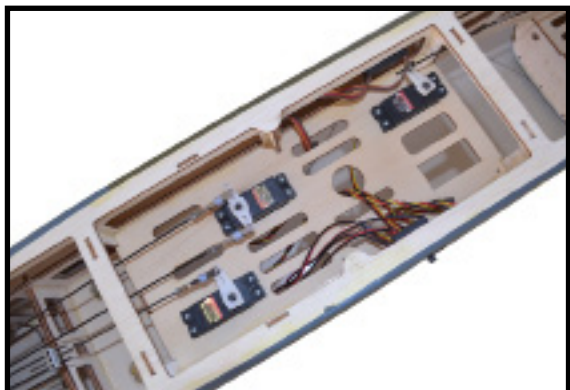

**TAIL STRUTS INSTALLATION.**

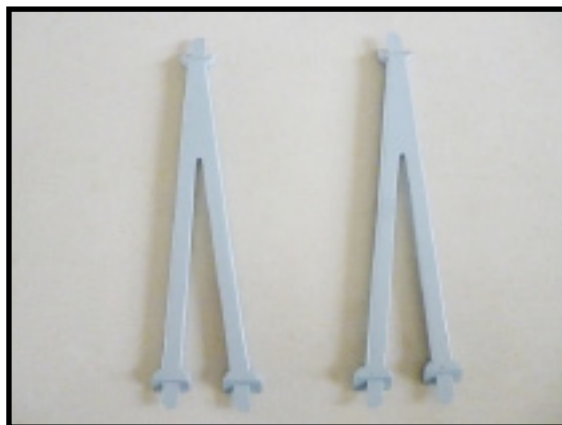
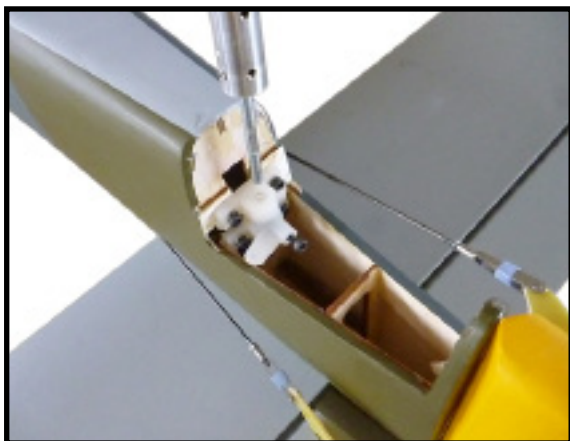



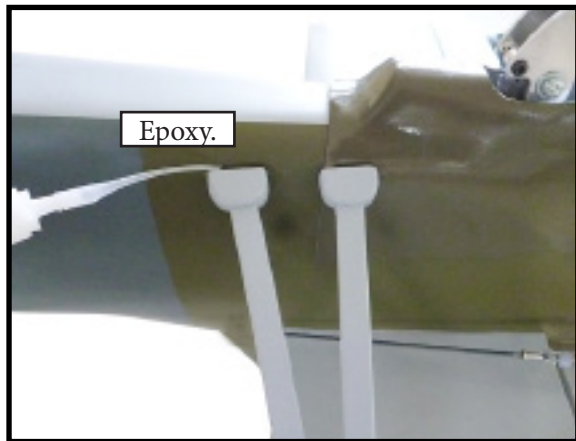
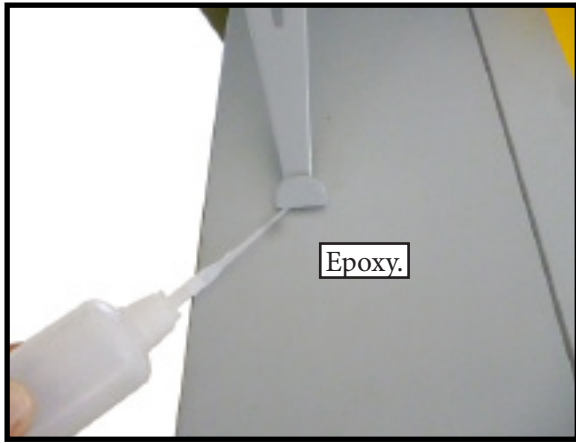

**SIDE FORCE GENERATOR OF STABILIZER ASSEMBLY.**

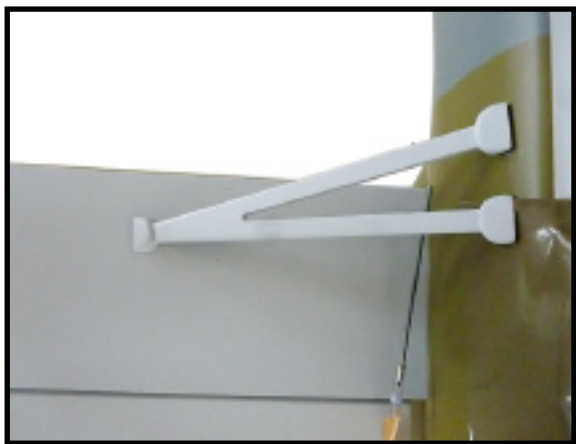
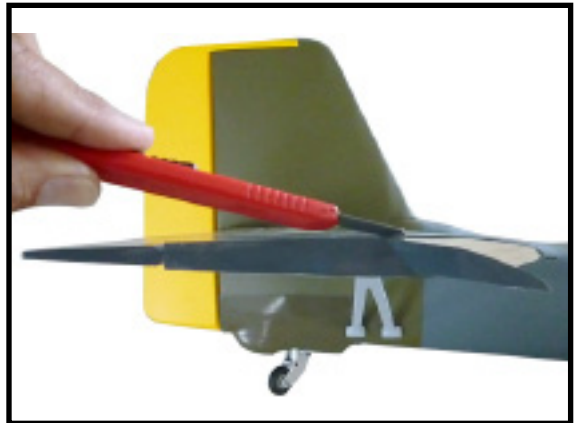

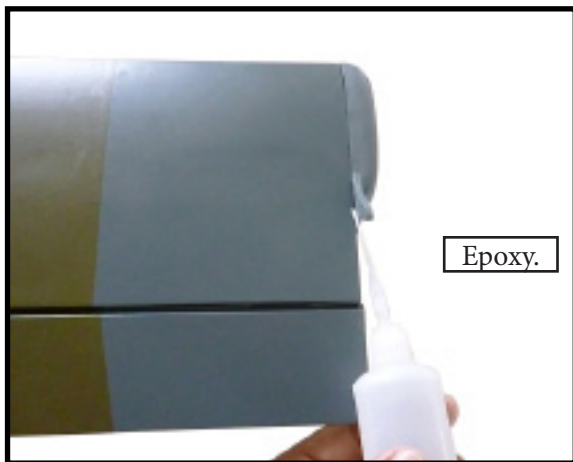
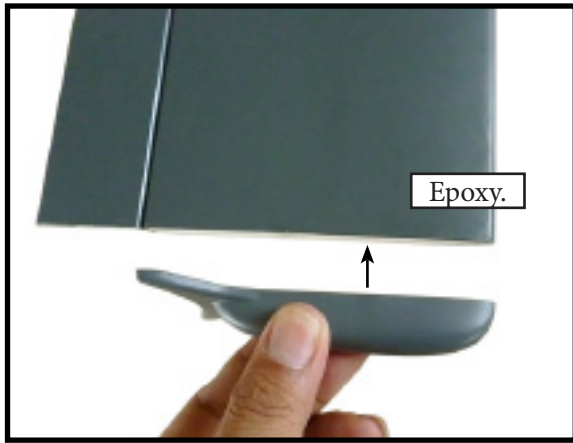

**INSTALLATION PILOT AND CANOPY.**

1) Locate items necessary to install pilot, seats.

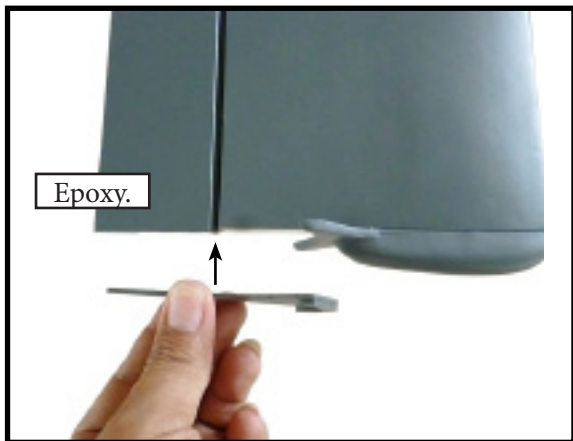
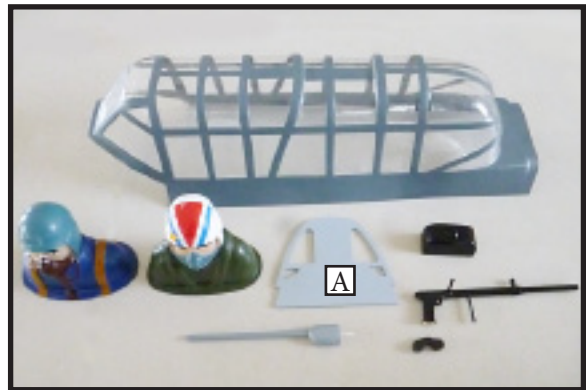

2) Assembly gun as below steps.

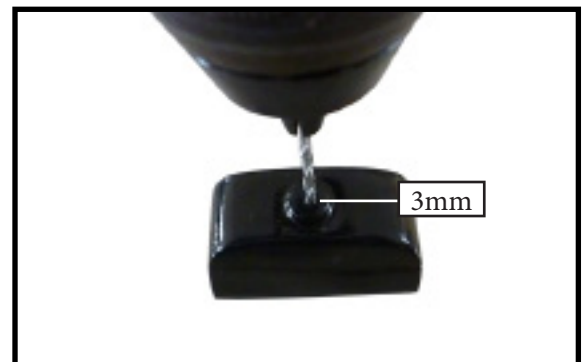

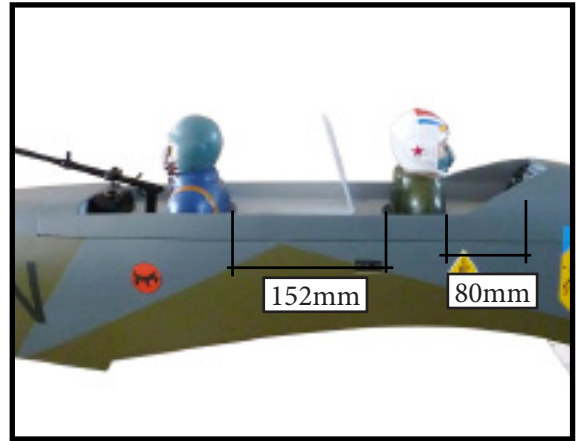

5) Drill hole on canopy.

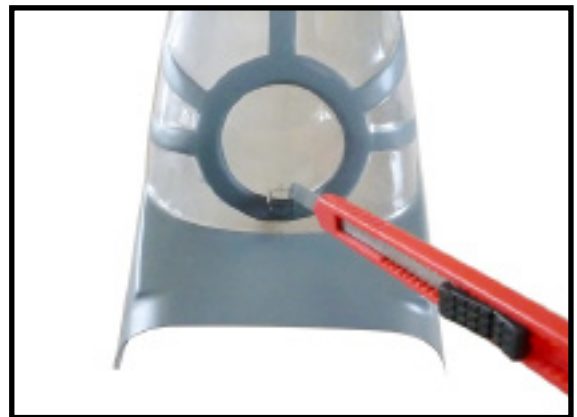

3) A scale pilot is included with this ARF. The Pilot included fitting well to the cockpit. (or you can order others scale pilot figures made by SG Models. They are available at SG Models distributors.)

If you are going to install a pilot figure, please use a sanding bar to sand the base of the figure so that it is flat.

4) Position the pilot figure on the canopy floor as shown. Use epoxy to glue the base of the pilot figure to the cockpit floor, please see pictures as shown.

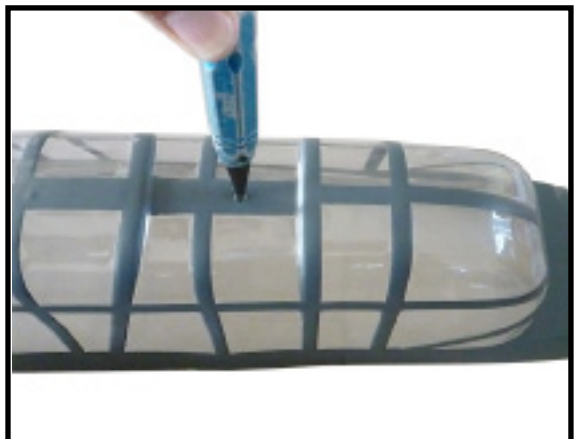
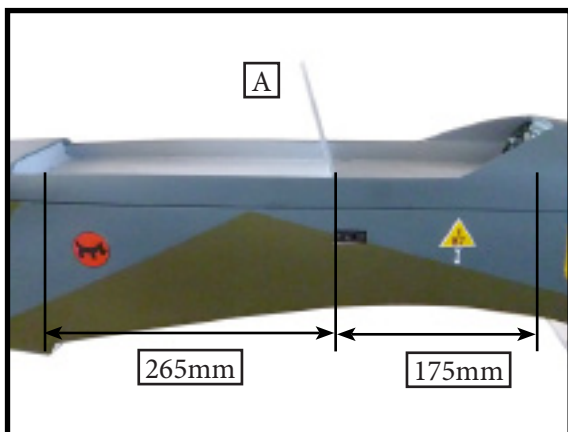

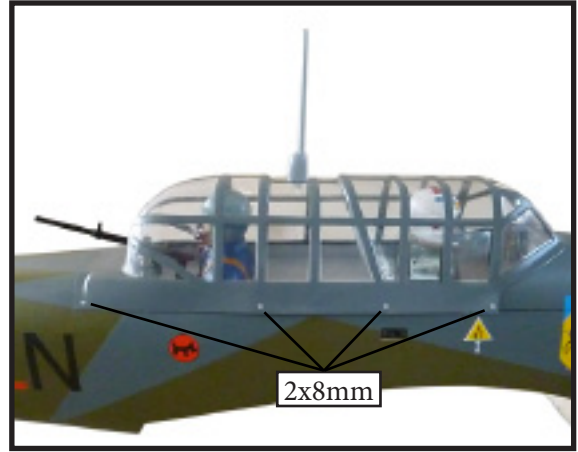
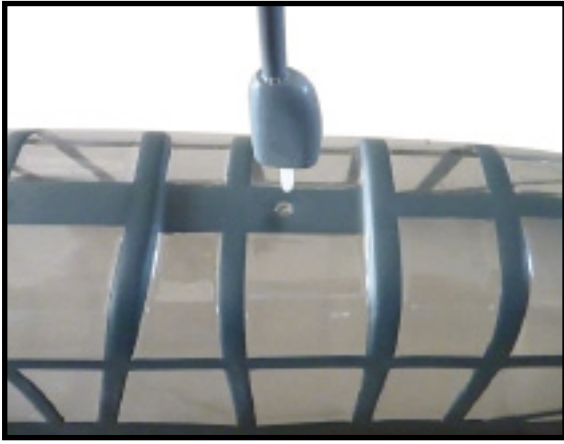

### APPLY THE DECALS.

The decals are sticky-back type. Most are factory die-cut to shape. If you want to trim the edges closer, use a sharp #11 hobby knife. Small decals can be applied by simply removing the paper backing sheet, and then lay the decal in position.

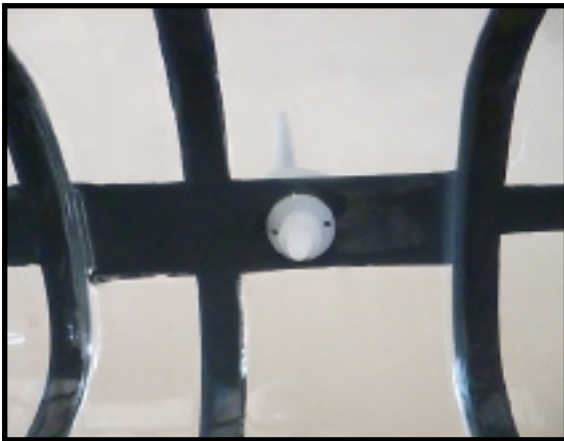

For the larger decals we recommend a “wet” application method - 1) Peel the paper backing sheet off the decal.; 2) Use a soapy water product (like window cleaner) to spray the adhesive side of the decal. Also spray the area of the model where the decal goes.; 3) Lightly place the decal onto the wet surface of the model. The liquid cleaner will keep the decal from sticking to the model, to give you time to shift it around into exact position.; 4) Once in position, use a piece of stiff cardboard to squeegee the excess liquid out from under the decal. Squeegee repeatedly, removing all excess liquid and air bubbles. Mop up the liquid with a paper towel. Allow to dry overnight.



### INSTALLING BATTERY - RECEIVER.

1) Plug the servos leads and the switch lead into the receiver. Plug the battery pack lead into the switch also.

2) Wrap the receiver and battery pack in the protective foam rubber to protect them from vibration.

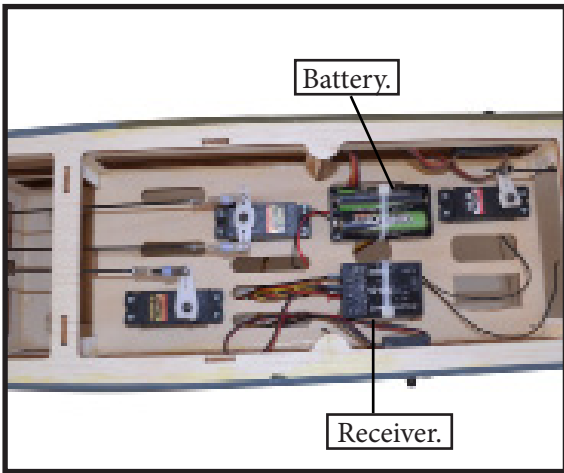

**ATTACHMENT WING- FUSELAGE.**

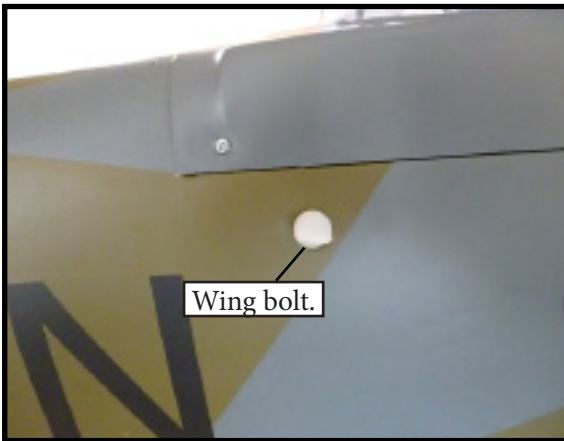

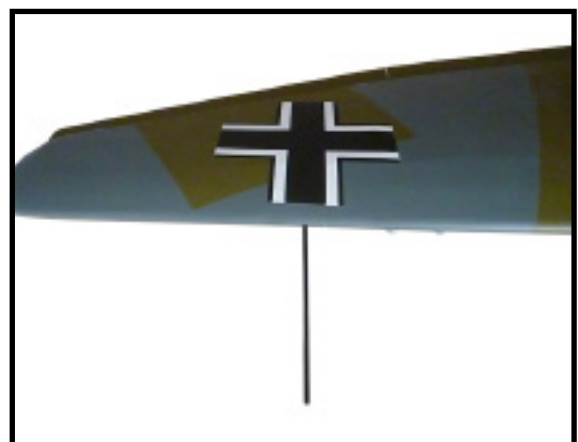
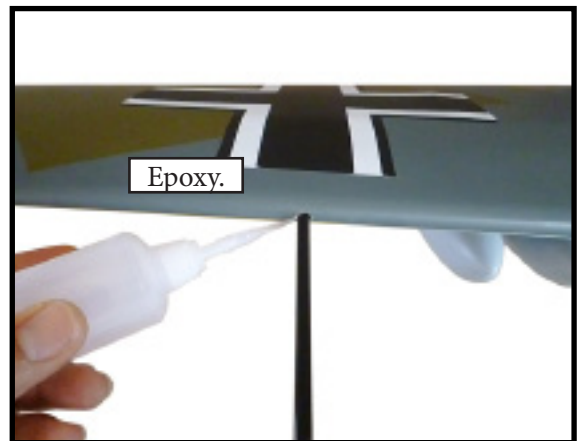
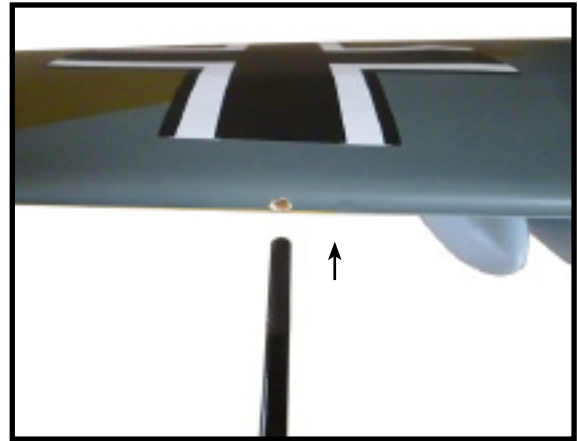
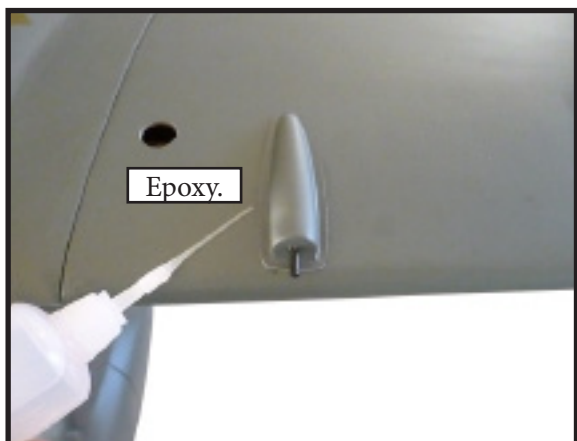

**ADJUSTMENT AILERON.**

Final step and also really necessary is adjust aileron. Please do it as shown.



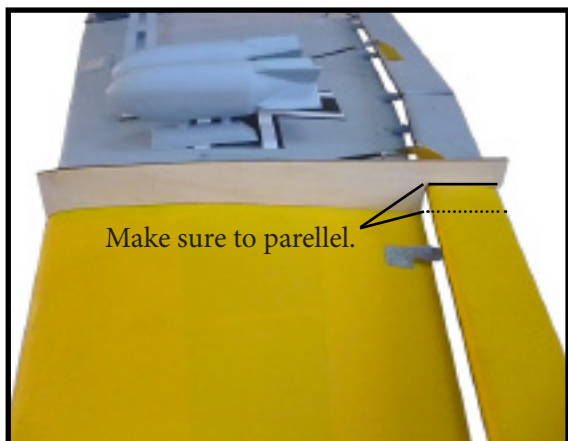
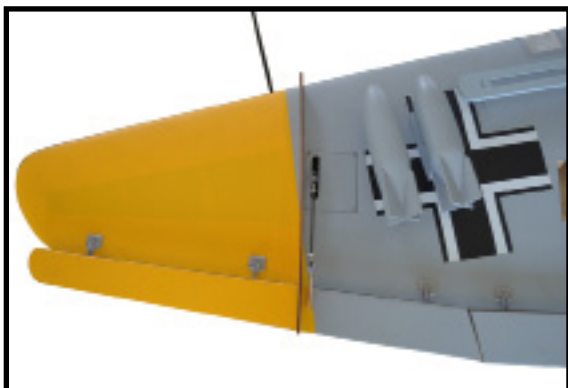

## BALANCING.

- 1) It is critical that your airplane be balanced correctly. Improper balance will cause your plane to lose control and crash. THE CENTER OF GRAVITY IS LOCATED **130MM** BACK FROM THE LEADING EDGE OF THE WING AT THE WING ROOT.
- 2) Mount the wing to the fuselage. Using a couple of pieces of masking tape, place them on the top side of the wing **130mm** back from the leading edge of the wing at the wing root.
- 3) With the model inverted, place your fingers on the masking tape and carefully lift the plane.

Accurately mark the balance point on the top of the wing on both sides of the fuselage. The balance point is located **130mm** back from the leading edge of the wing at the wing root. This is the balance point at which your model should balance for your first flights. Later, you may wish to experiment by shifting the balance up to 10mm forward or back to change the flying characteristics. Moving the balance forward may improve the smoothness and arrow-like tracking, but it may then require more speed for take off and make it more difficult to slow down for landing. Moving the balance aft makes the model more agile with a lighter and snappier "feel". In any case, please start at the location we recommend.

With the wing attached to the fuselage, all parts of the model installed ( ready to fly), and empty fuel tanks, hold the model at the marked balance point with the stabilizer level.

Lift the model. If the tail drops when you lift, the model is "tail heavy" and you must add weight\* to the nose. If the nose drops, it is "nose heavy" and you must add weight\* to the tail to balance.

\*If possible, first attempt to balance the model by changing the position of the receiver battery and receiver. If you are unable to obtain good balance by doing so, then it will be necessary to add weight to the nose or tail to achieve the proper balance point.

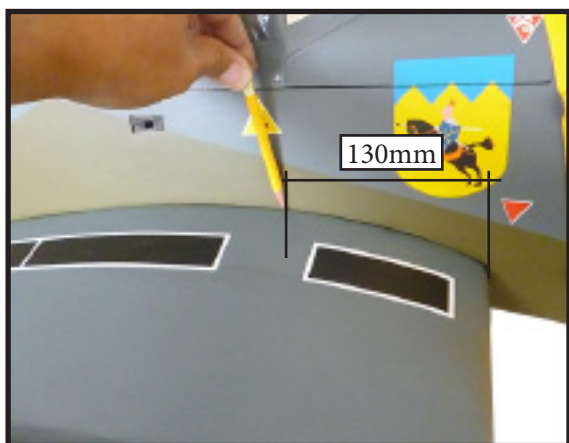

**CONTROL THROWS.**

<b>Ailerons:</b>	<b>Rudder:</b>
High Rate :	High Rate :
Up : 18mm	Right : 30mm
Down : 18mm	Left : 30mm
Low Rate :	Low Rate :
Up : 13mm	Right : 25mm
Down : 13mm	Left : 25mm
<b>Elevator:</b>	<b>Flap:</b>
High Rate :	Mid : 25mm
Up : 20mm	Landing : 35mm
Down : 20mm	
Low Rate :	
Up : 15mm	
Down : 15mm	

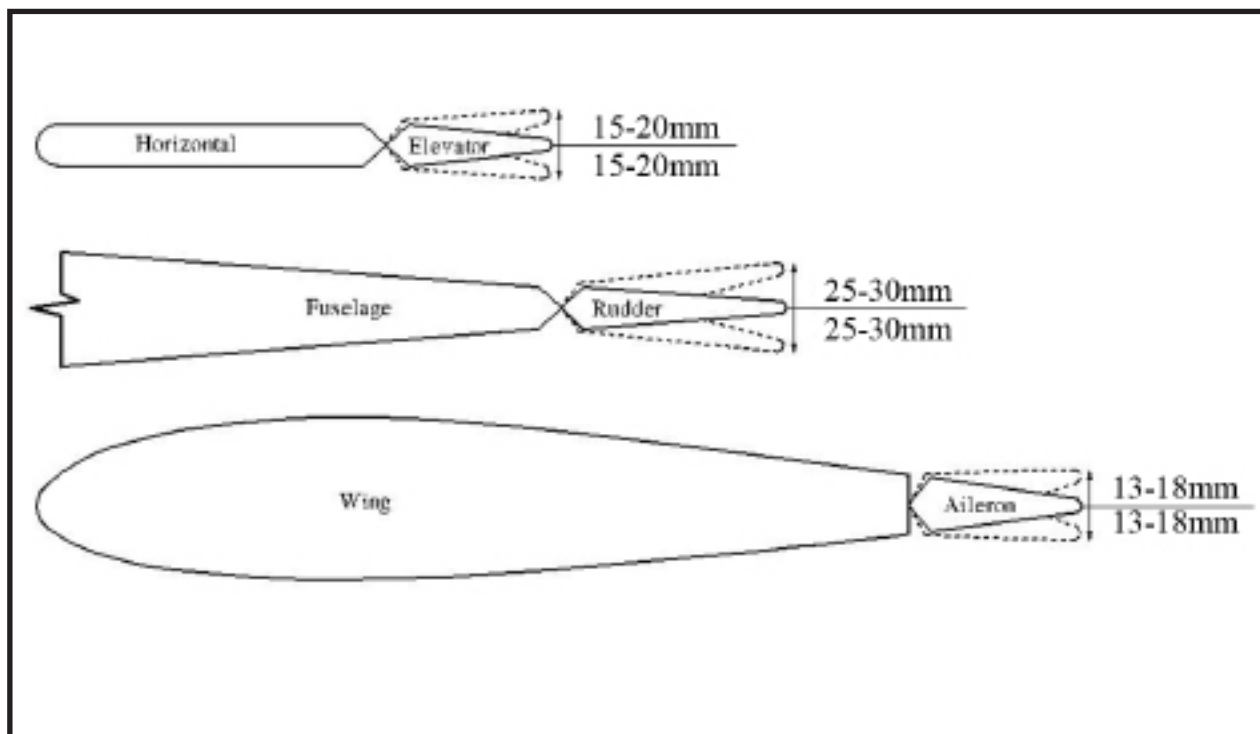



## FLIGHT PREPARATION.

Check the operation and direction of the elevator, rudder, ailerons and throttle.

□ A) Plug in your radio system per the manufacturer's instructions and turn everything on.

□ B) Check the elevator first. Pull back on the elevator stick. The elevator halves should move up. If they do not, flip the servo reversing switch on your transmitter to change the direction.

□ C) Check the rudder. Looking from behind the airplane, move the rudder stick to the right. The rudder should move to the right. If it does not, flip the servo reversing switch on your transmitter to change the direction.

□ D) Check the throttle. Moving the throttle stick forward should open the carburetor barrel. If it does not, flip the servo reversing switch on your transmitter to change the direction.

□ E) From behind the airplane, look at the aileron on the right wing half. Move the aileron stick to the right. The right aileron should move up and the other aileron should move down. If it does not, flip the servo reversing switch on your transmitter to change the direction.

## PREFLIGHT CHECK.

□ 1) Completely charge your transmitter and receiver batteries before your first day of flying.

□ 2) Check every bolt and every glue joint in the **JU-87** to ensure that everything is tight and well bonded.

□ 3) Double check the balance of the airplane. Do this with the fuel tank empty.

□ 4) Check the control surfaces. All should move in the correct direction and not bind in any way.

□ 5) If your radio transmitter is equipped with dual rate switches double check that they are on the low rate setting for your first few flights.

□ 6) Check to ensure the control surfaces are moving the proper amount for both low and high rate settings.

□ 7) Check the receiver antenna. It should be fully extended and not coiled up inside the fuselage.

□ 8) Properly balance the propeller. An out of balance propeller will cause excessive vibration which could lead to engine and/or airframe failure.

*We wish you many safe and enjoyable flights  
with your JU-87 STUKA GIANT.*

*If you have any queries, or are interested in our products,  
please feel free to contact us*

**Factory :** 12/101A - Hamlet 4 - Le Van Khuong Street - Dong Thanh Ward -  
Hoc Mon District - Ho Chi Minh City - Viet Nam.

**Office :** 62/8 Ngo Tat To Street - Ward 19 - Binh Thanh District - Ho Chi Minh  
City - Viet Nam

**Phone :** 848 - 37114542 or 848- 36018777

**Website :** [www.SeagullModels.com](http://www.SeagullModels.com)

**Email :** [Sales@seagullmodels.com](mailto:Sales@seagullmodels.com)

**Facebook :** [www.facebook.com/SeaGullModels](http://www.facebook.com/SeaGullModels).