

# Rasant SPEED



HOCHAUFLÖSENDE BILDER DER BAUSCHRITTE  
HIGH-RESOLUTION IMAGES OF THE CONSTRUCTION STEPS  
IMAGES À HAUTE RÉOLUTION DES ÉTAPES DE CONSTRUCTION



EP-Version Nr.: 2684



GP-Version Nr.: 2685

[www.robbe.com](http://www.robbe.com)



V1\_10/2021

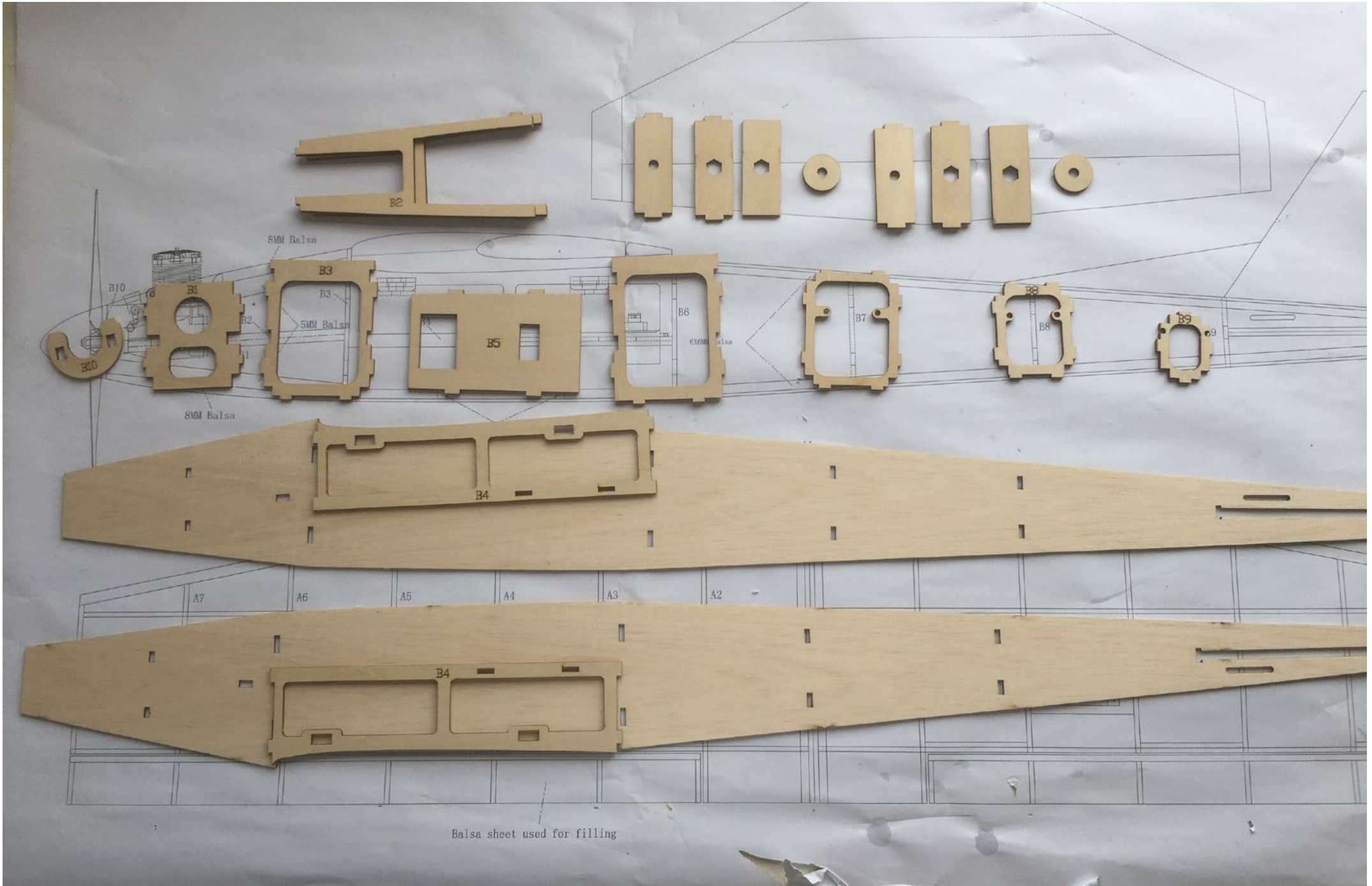

Balsa sheet used for filling

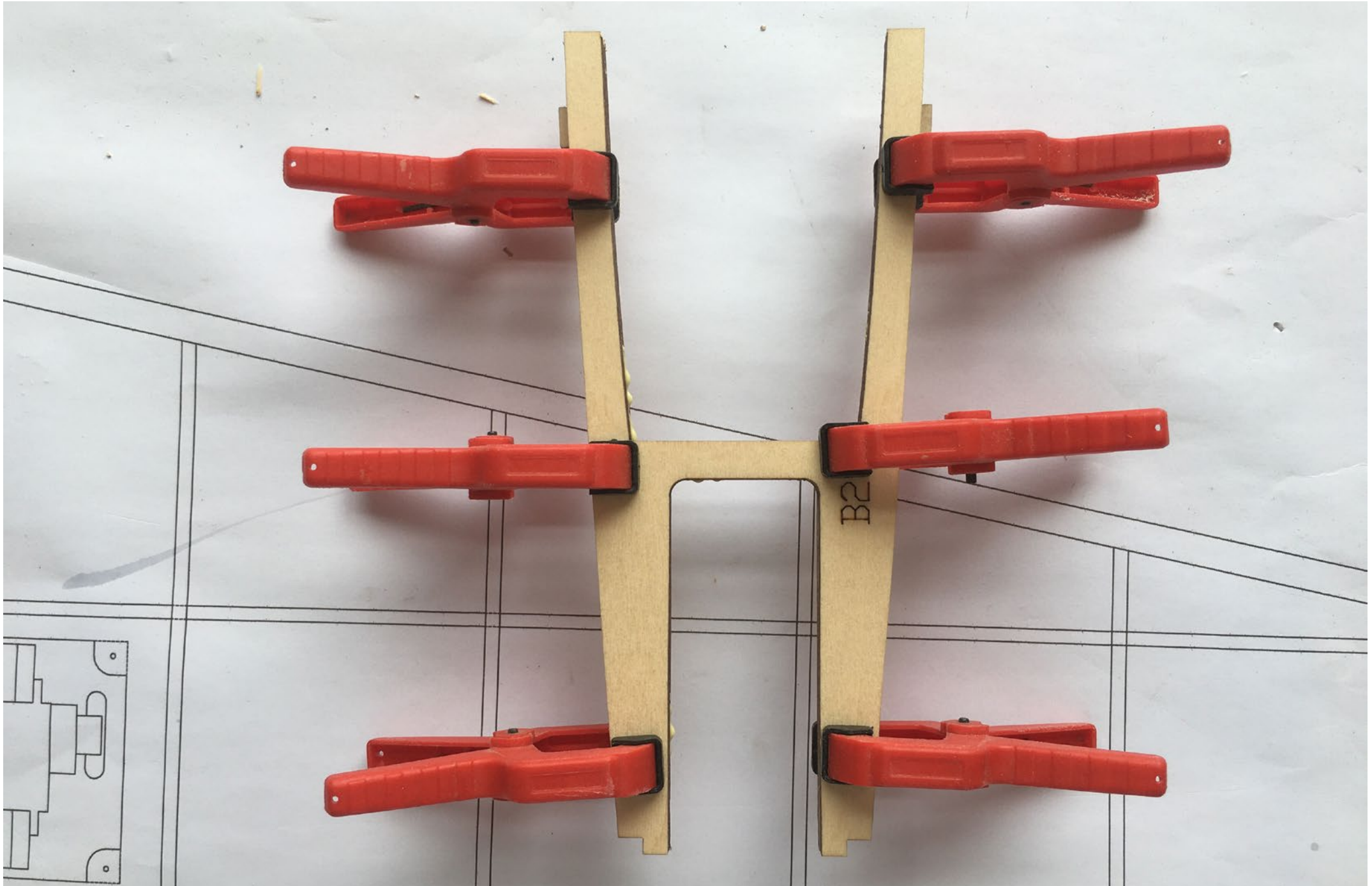

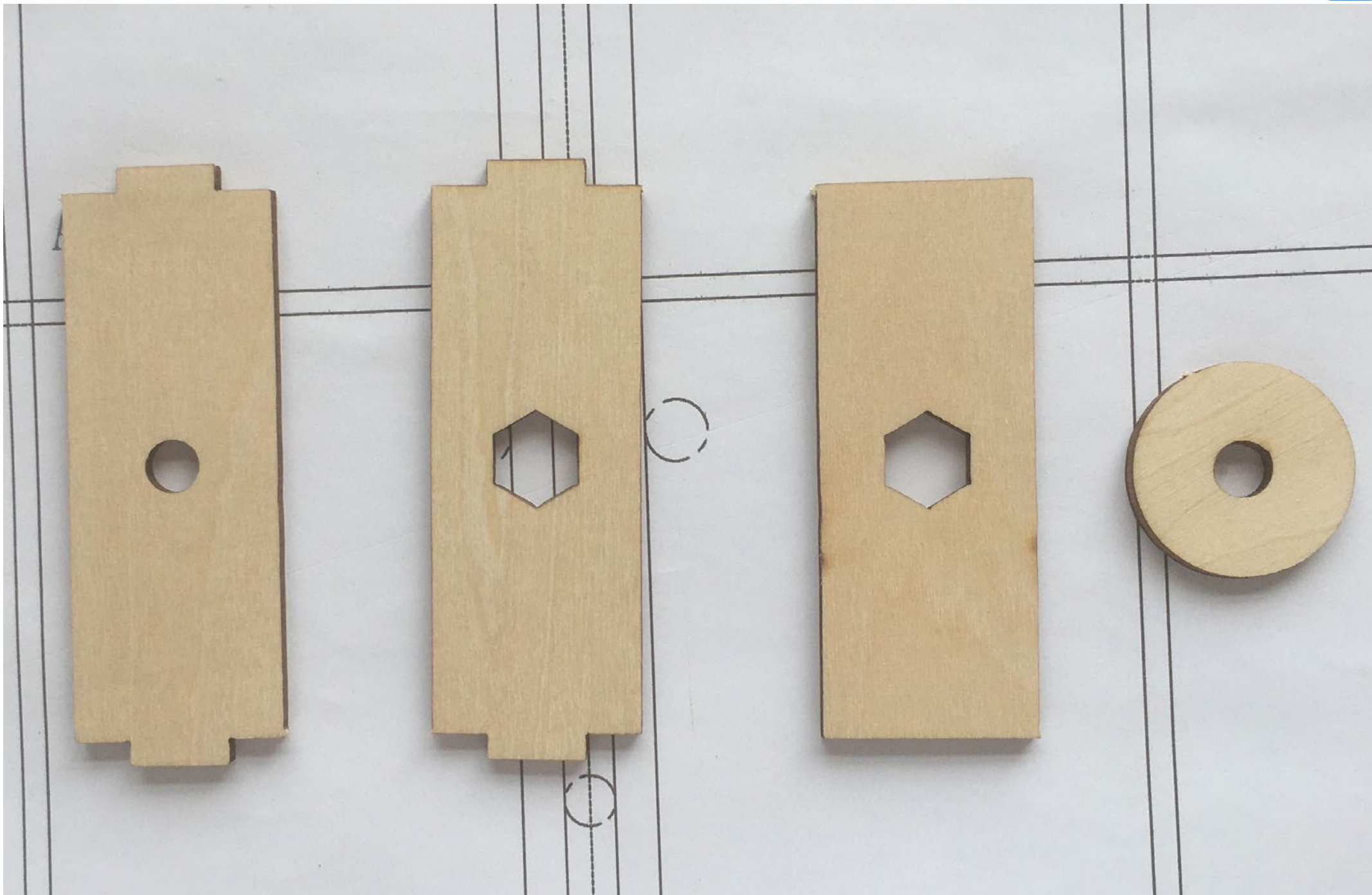

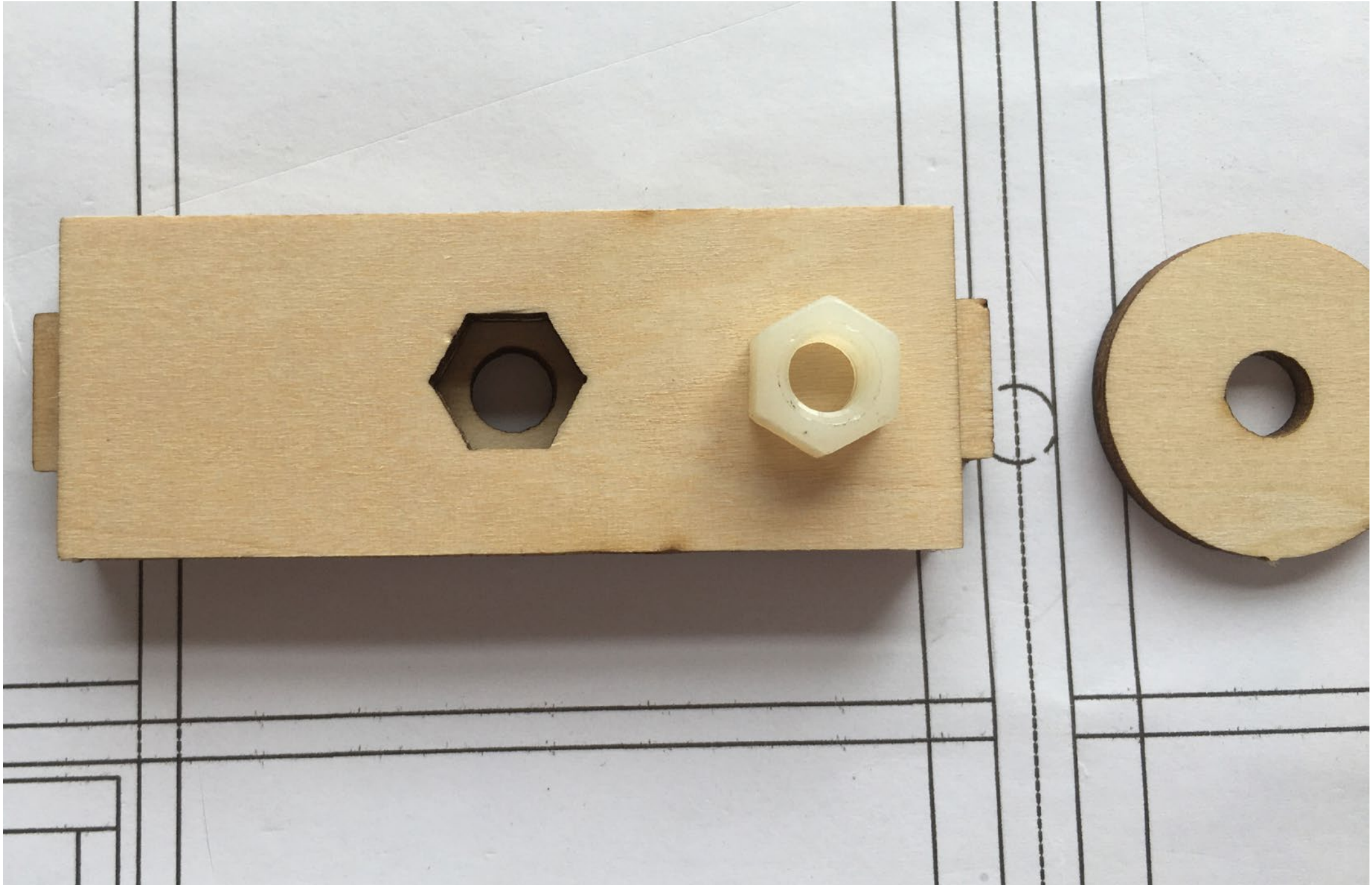

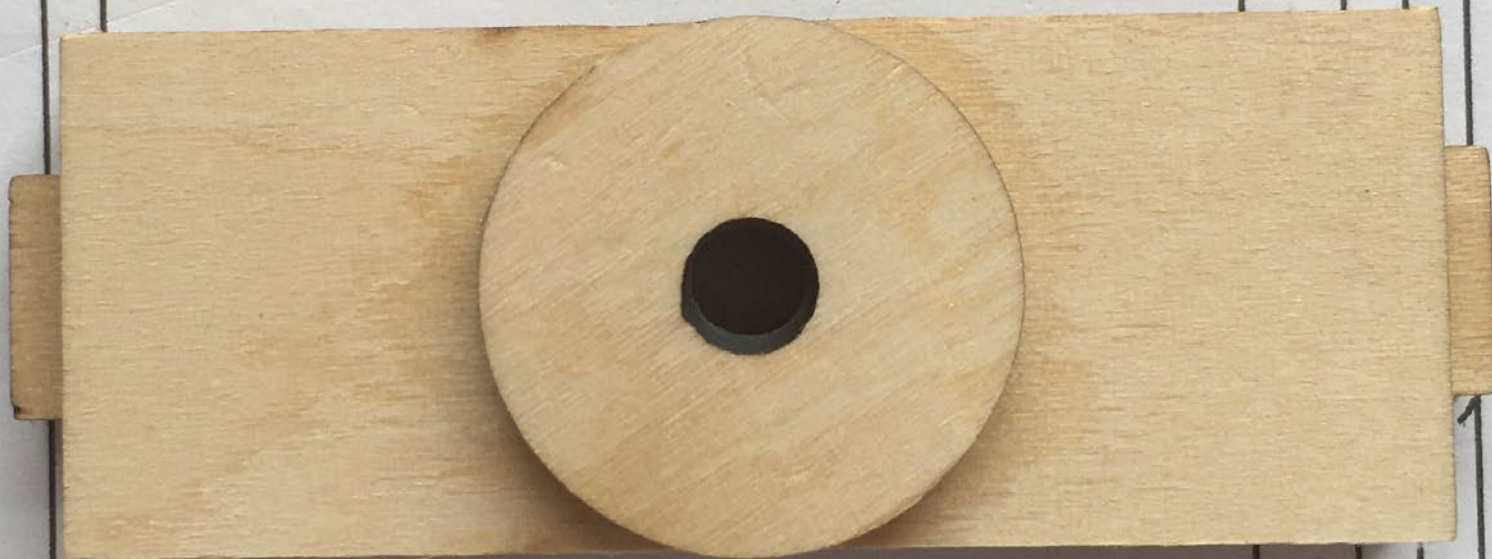

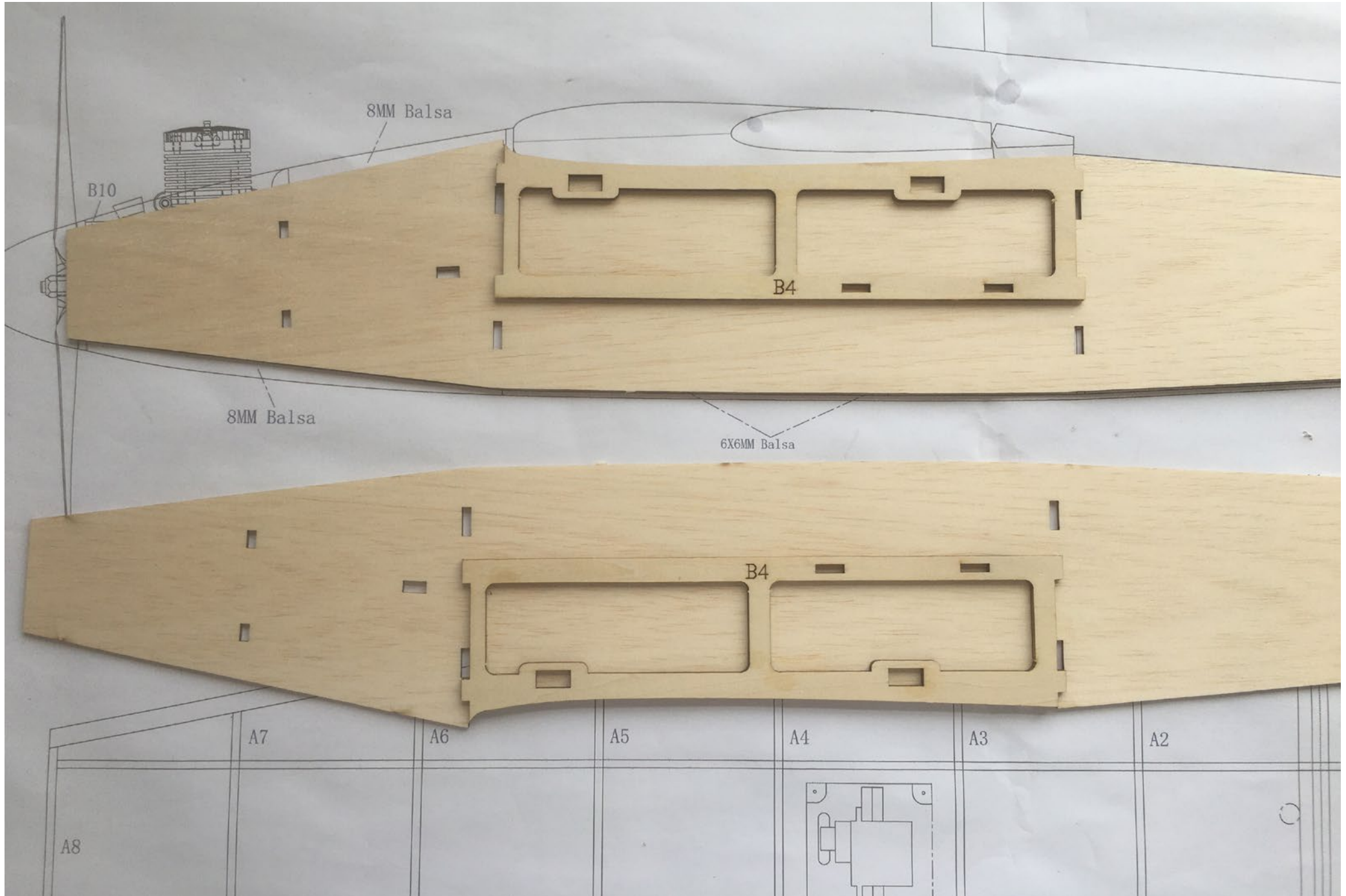

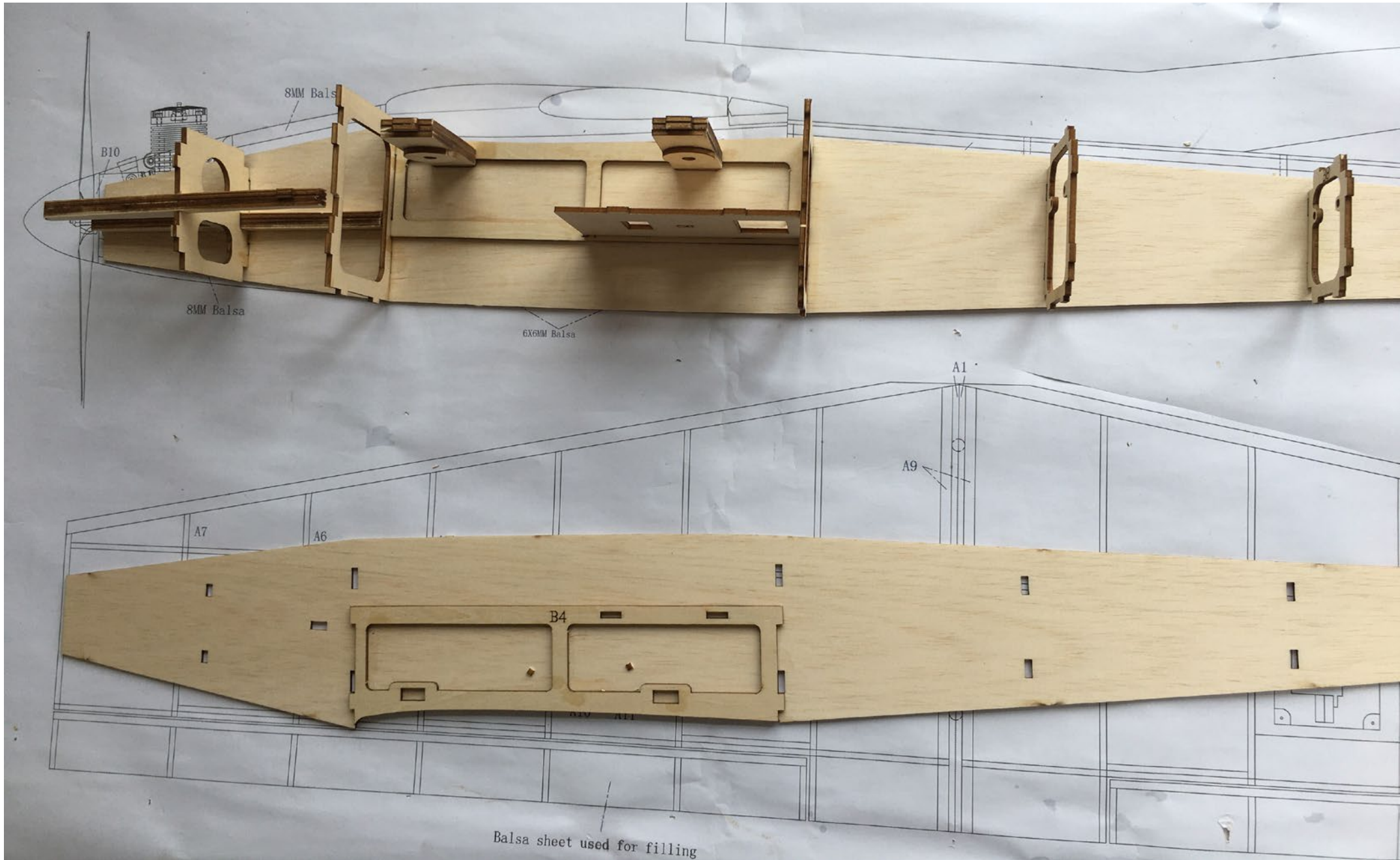



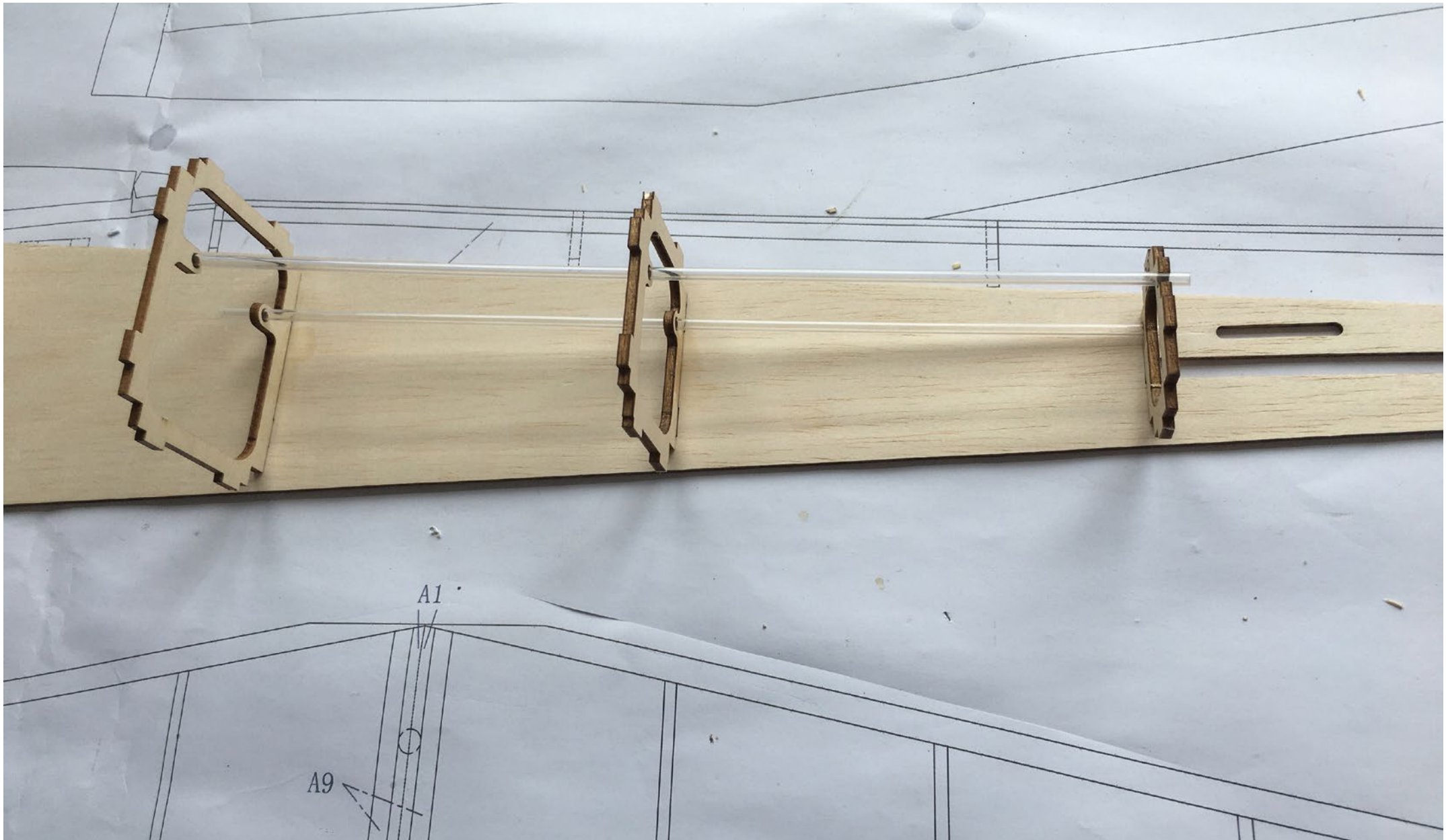

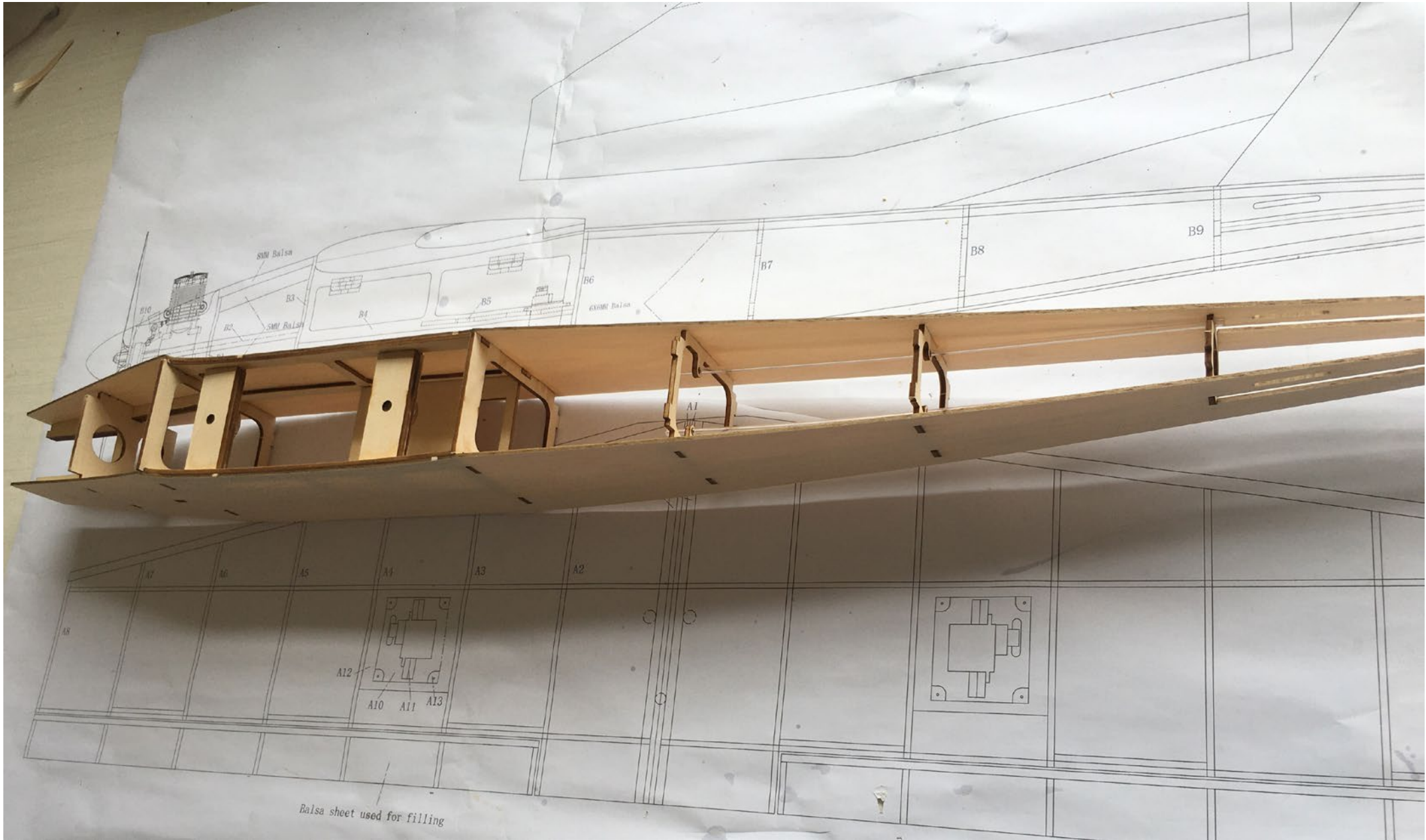

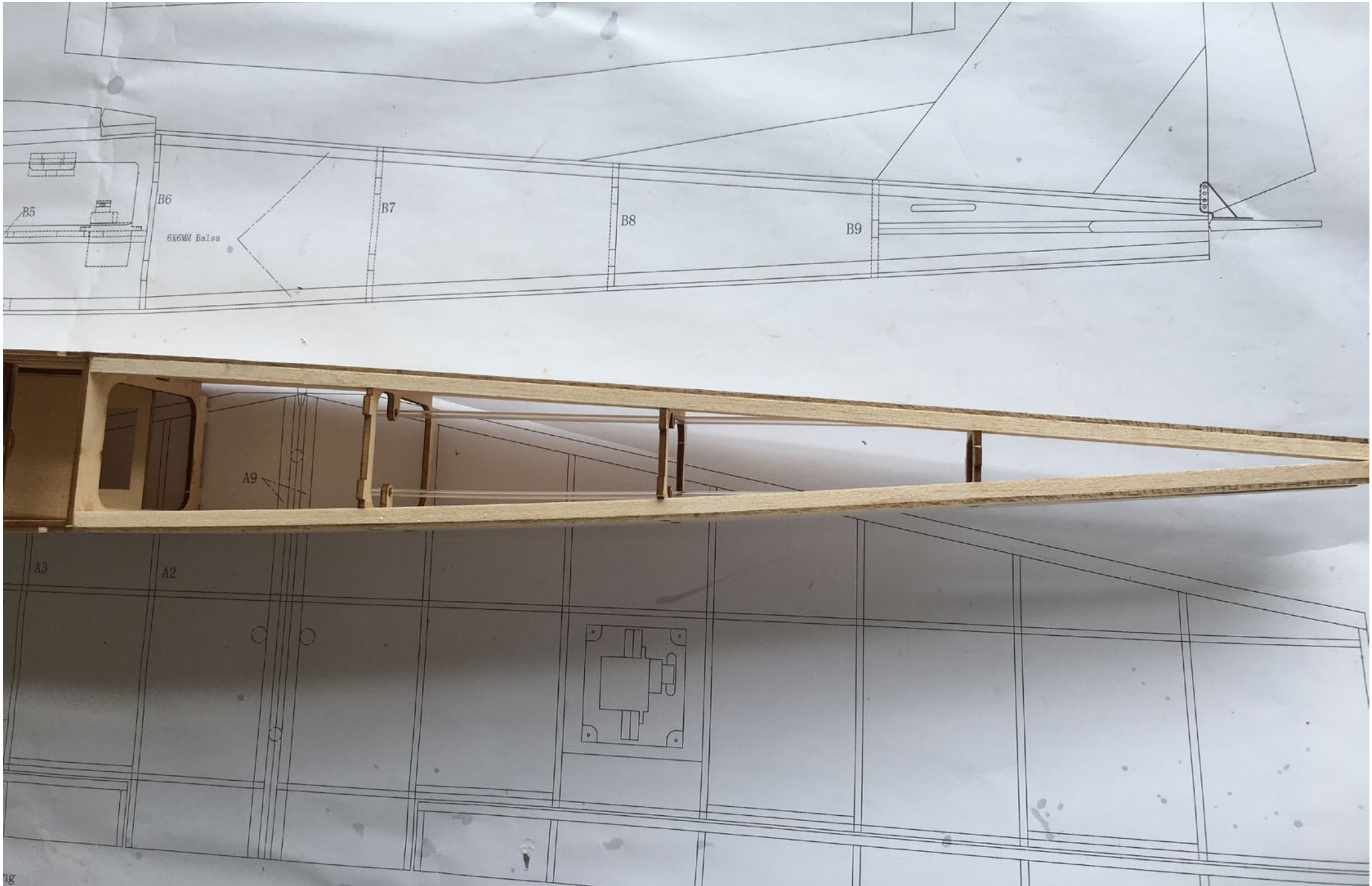

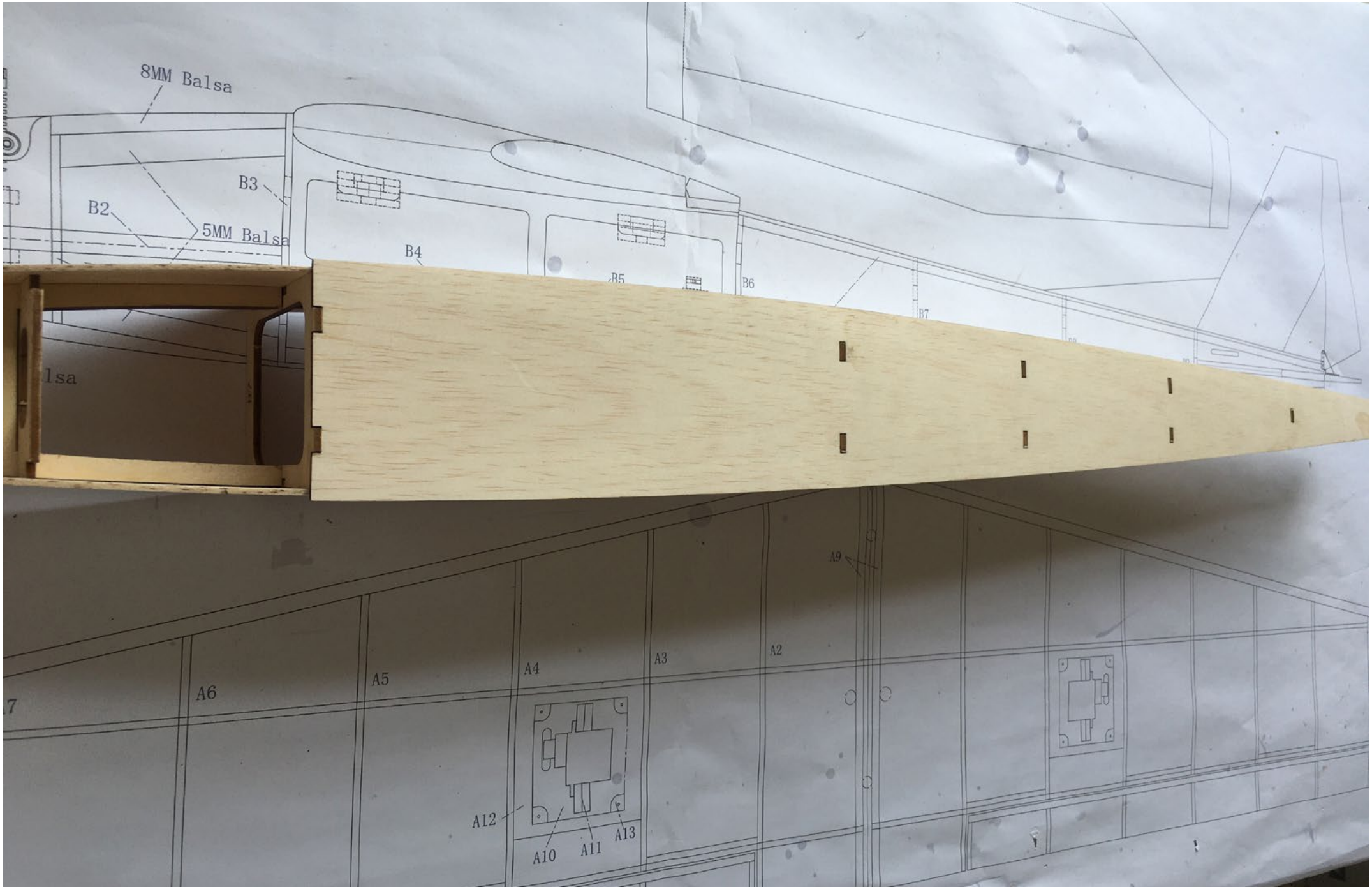















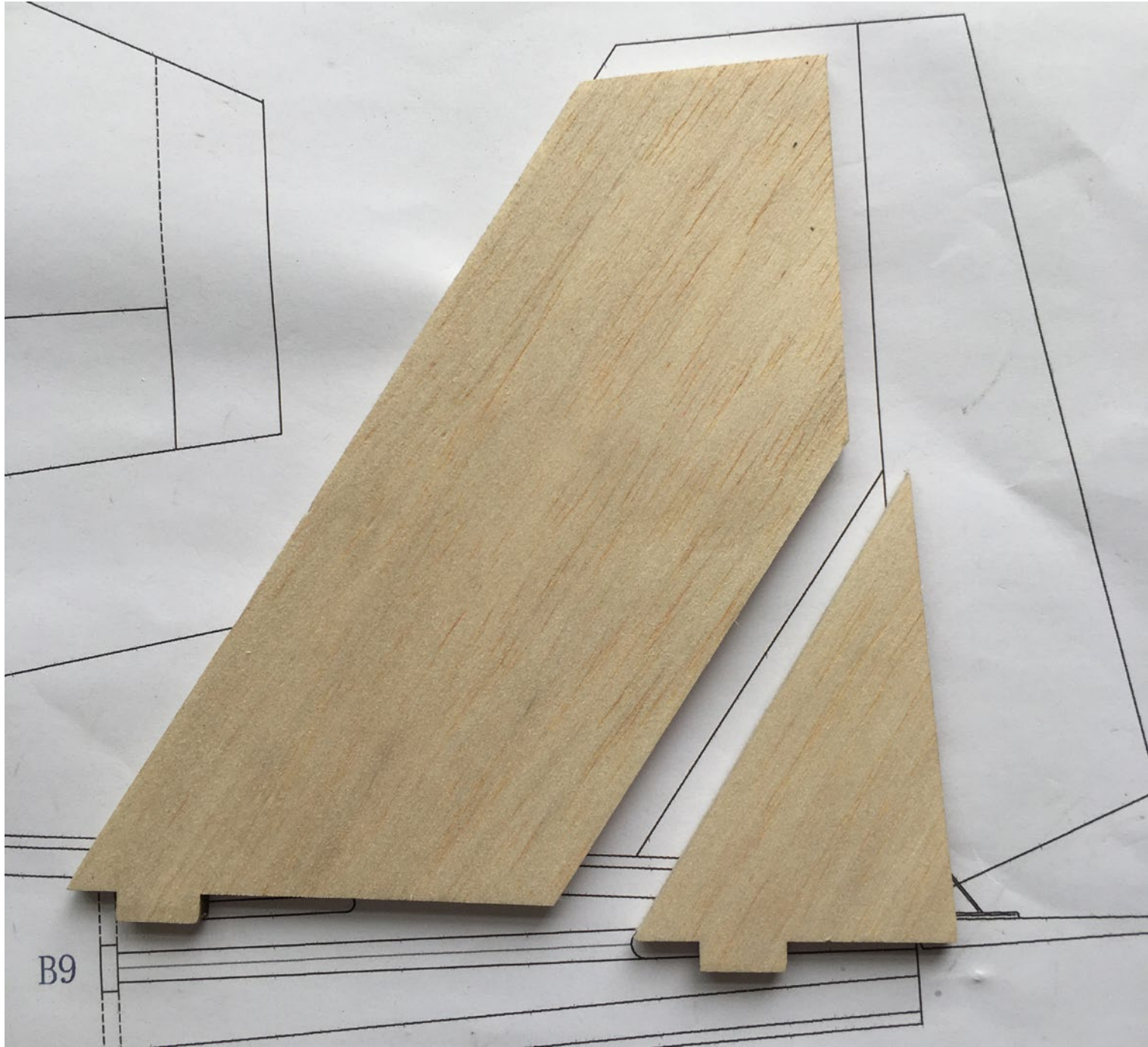

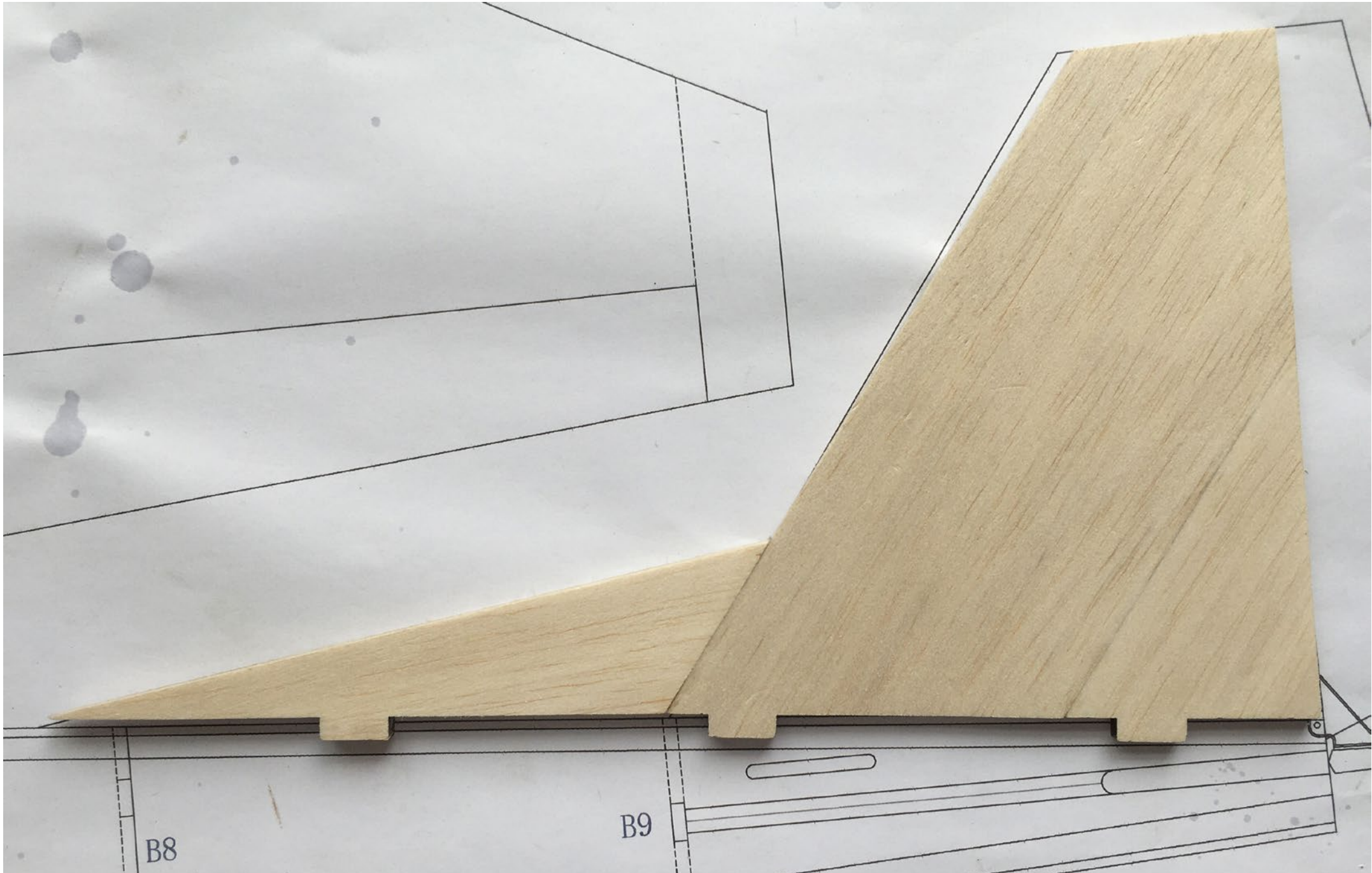

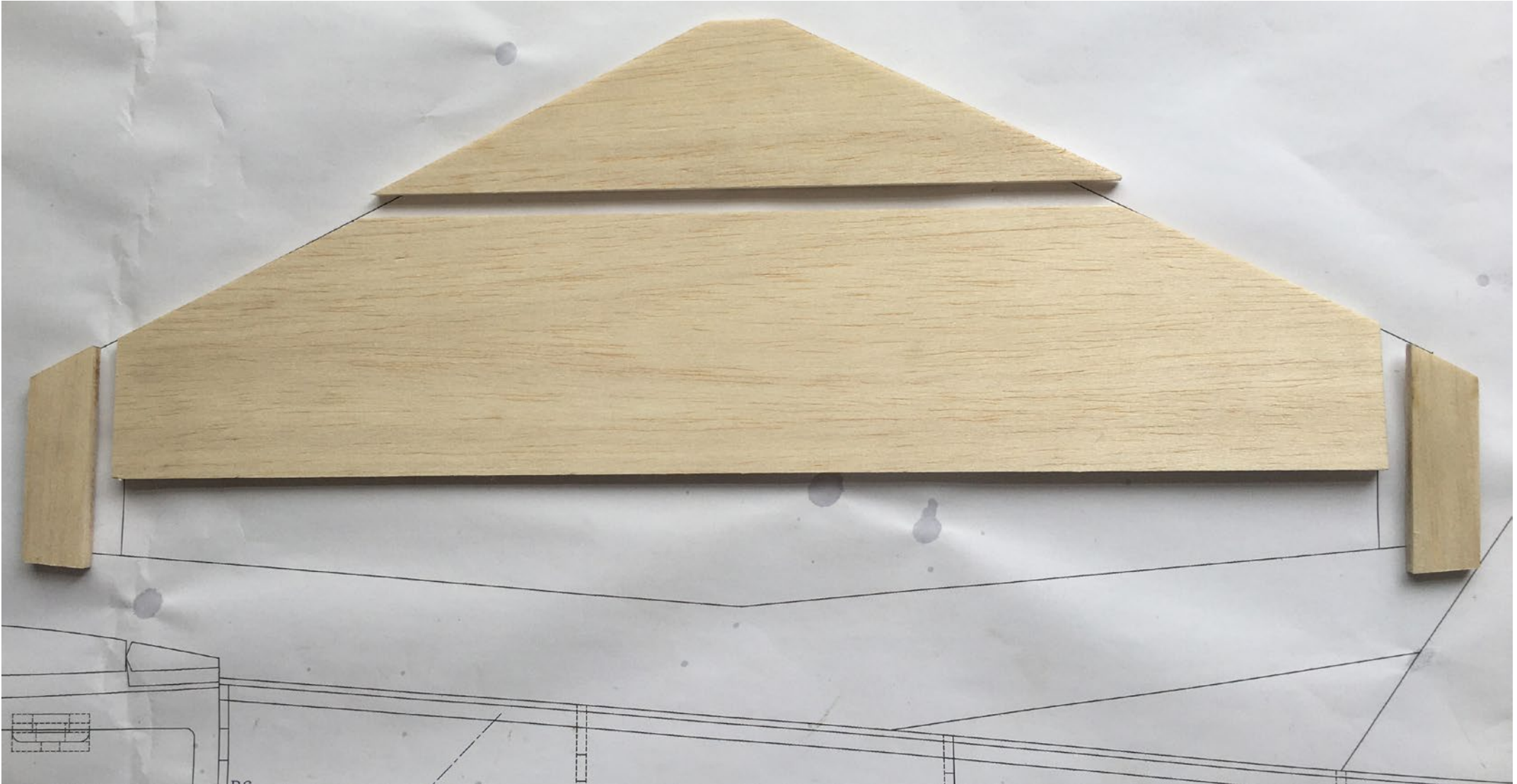



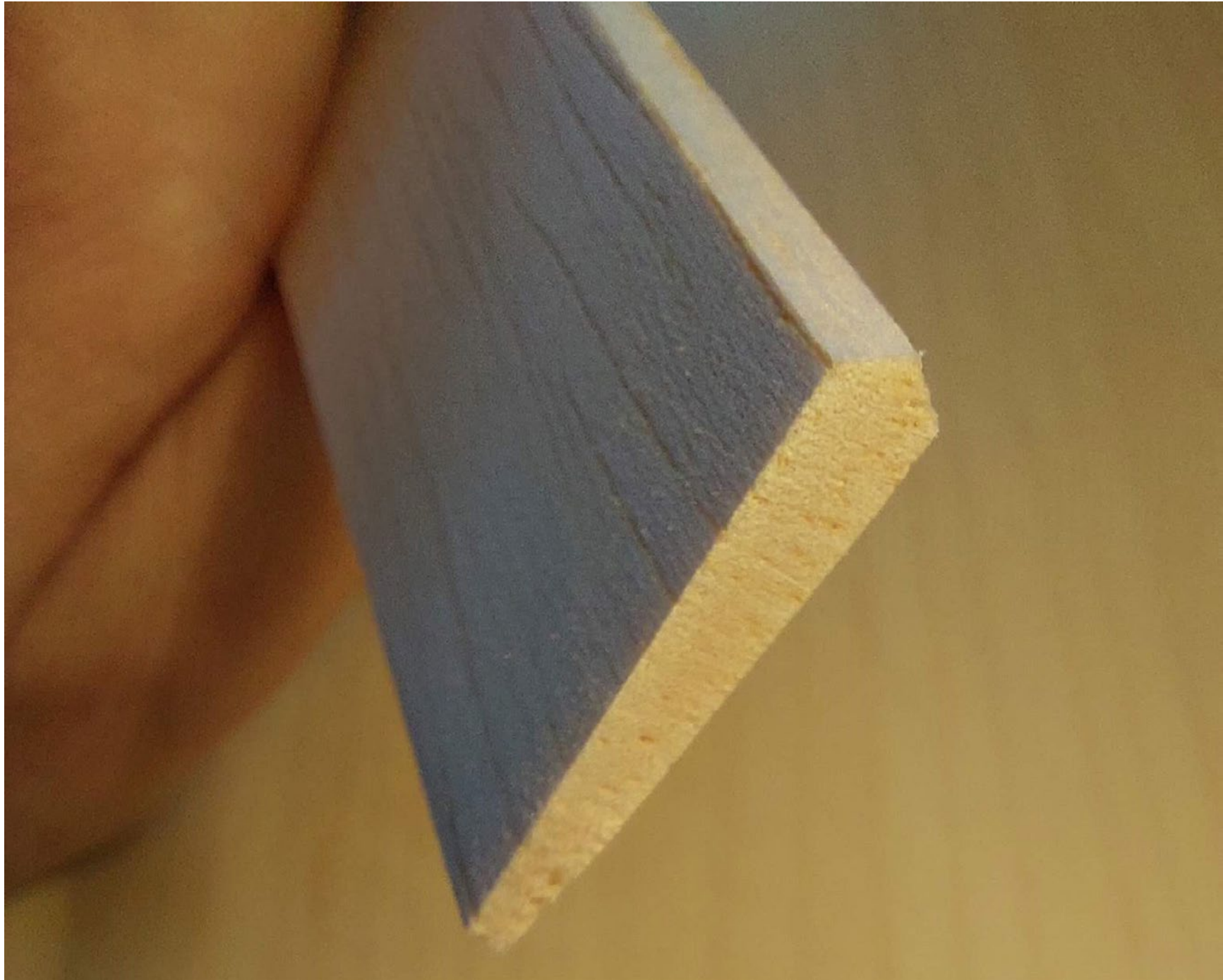



← **robbe**

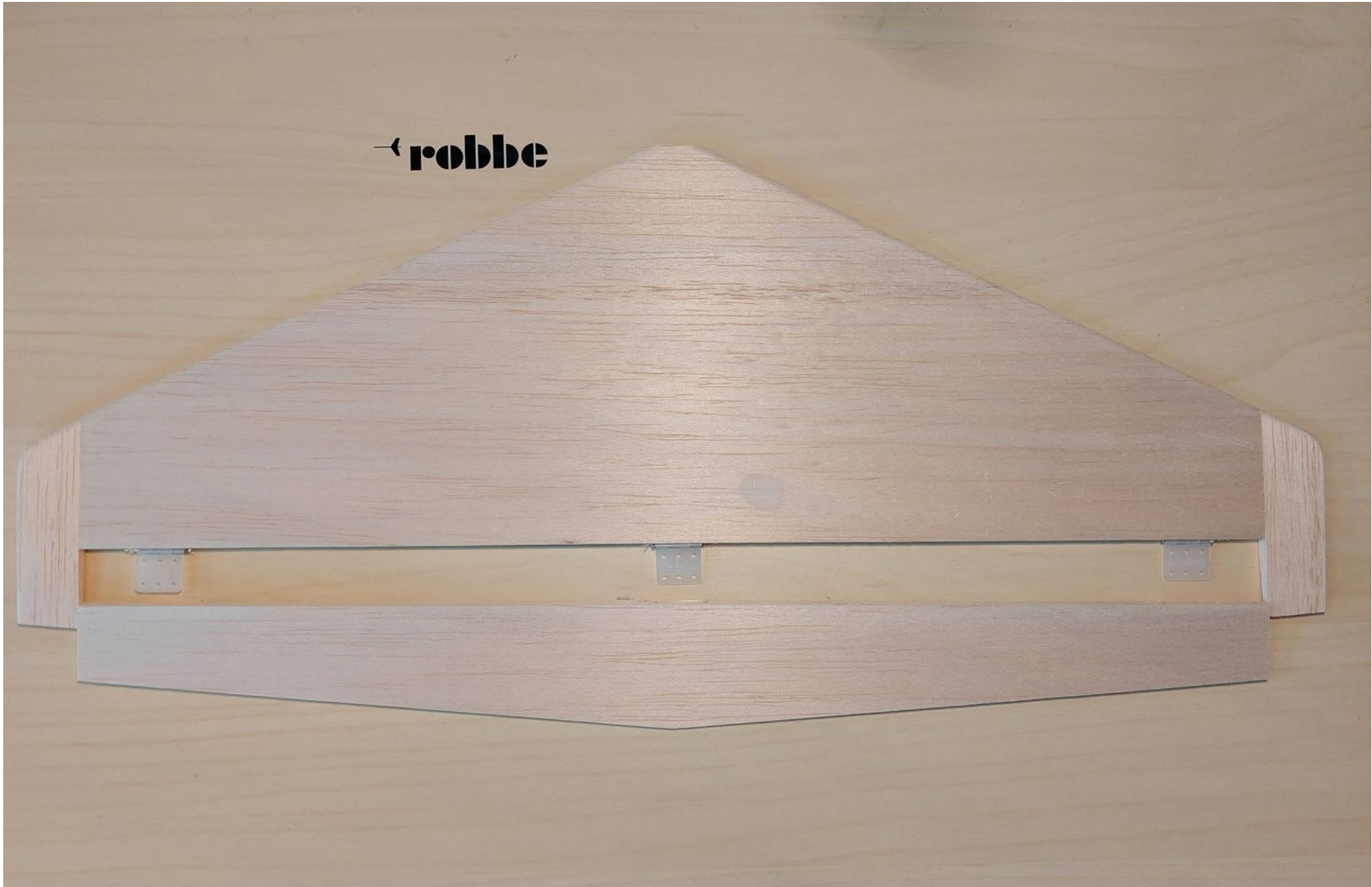





← **robbe**





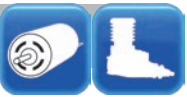

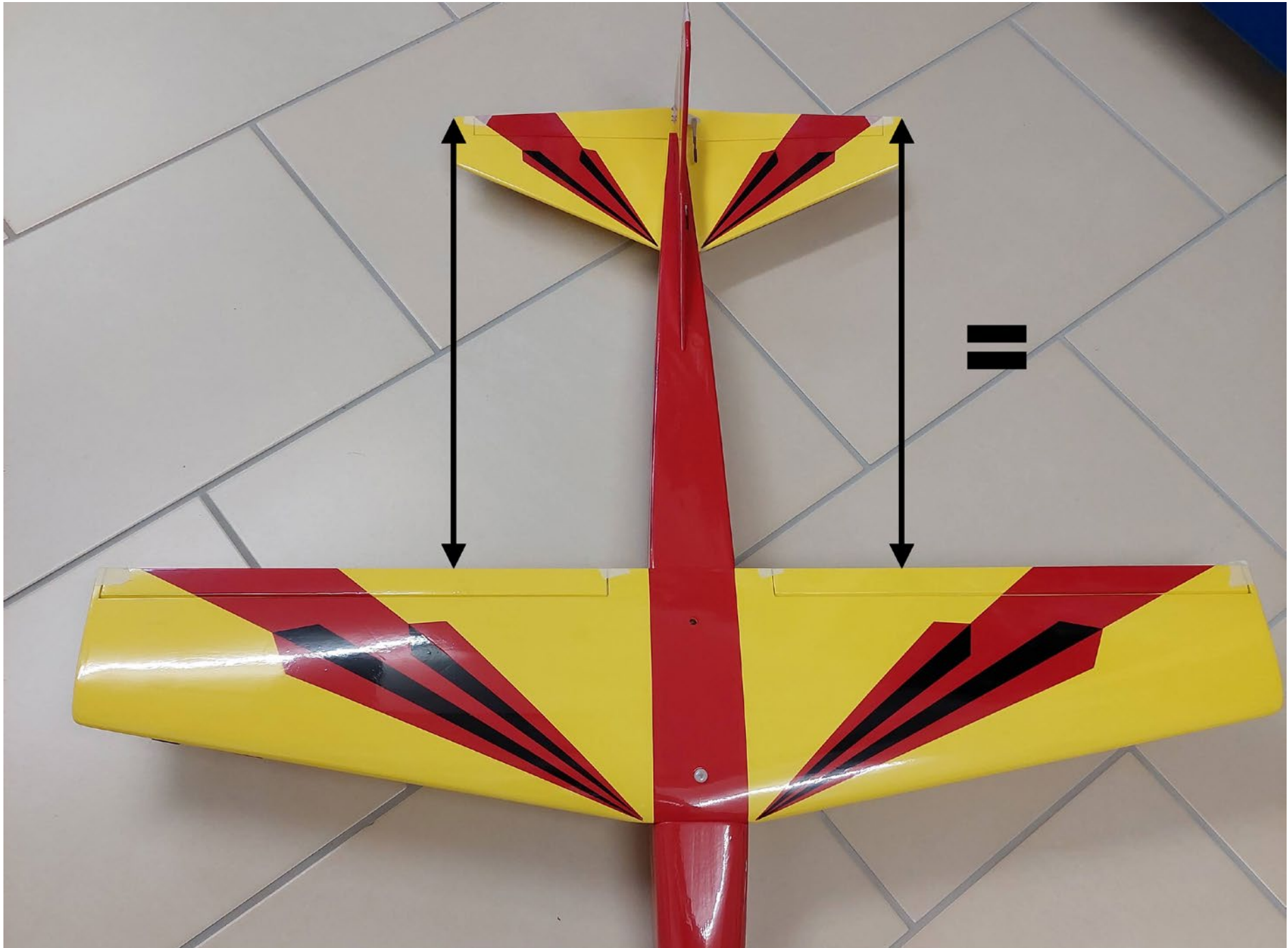

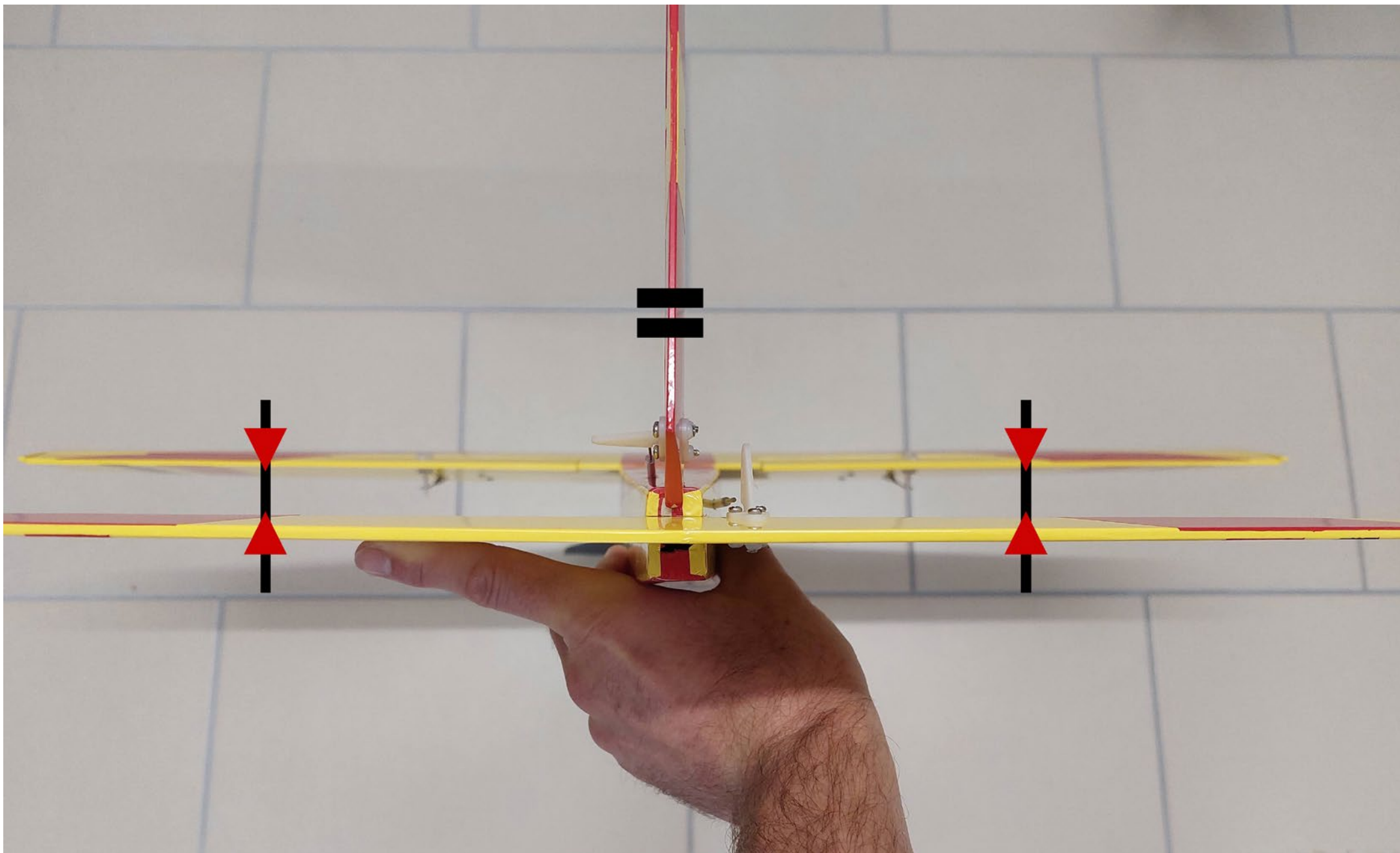





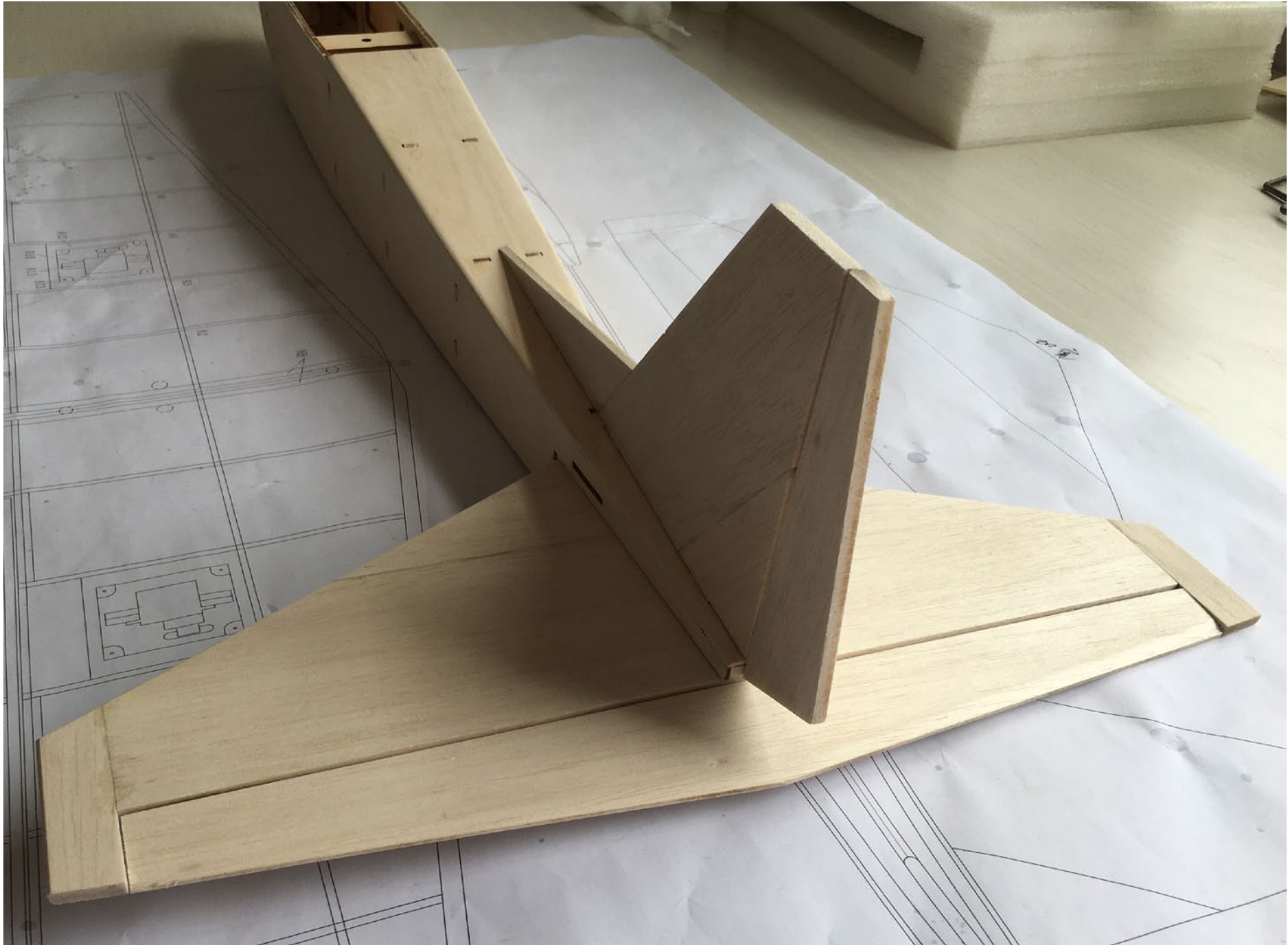





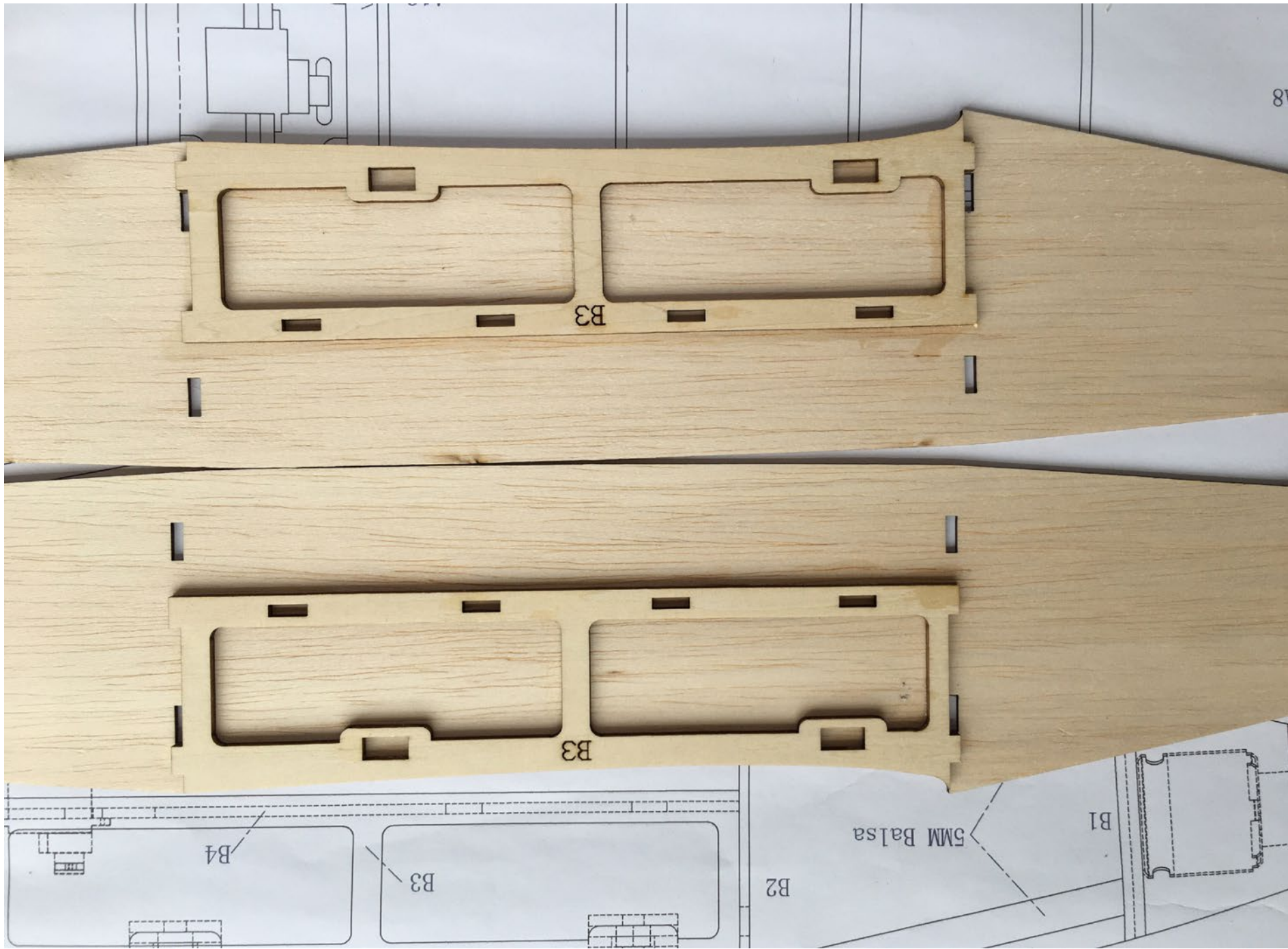

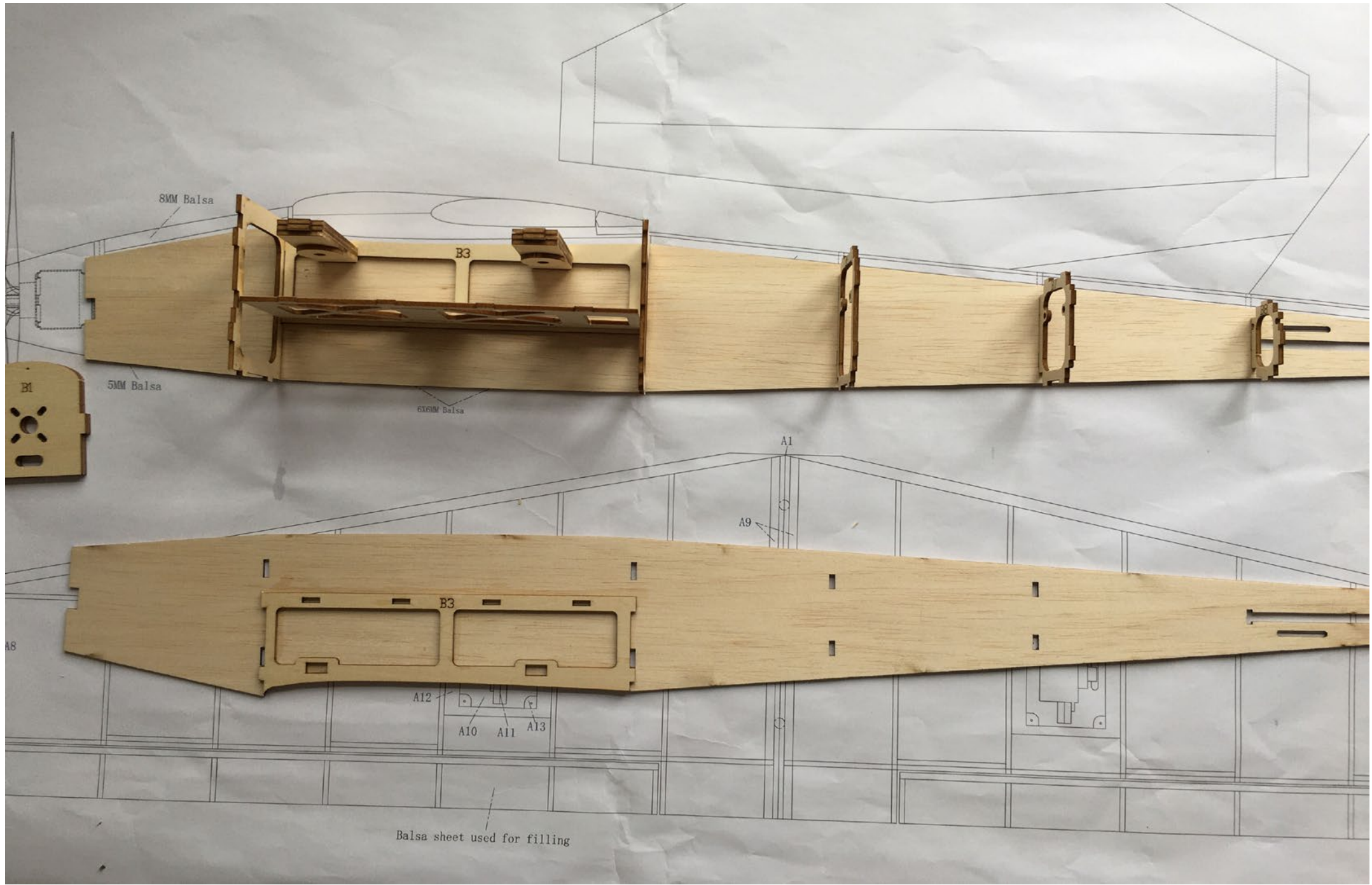

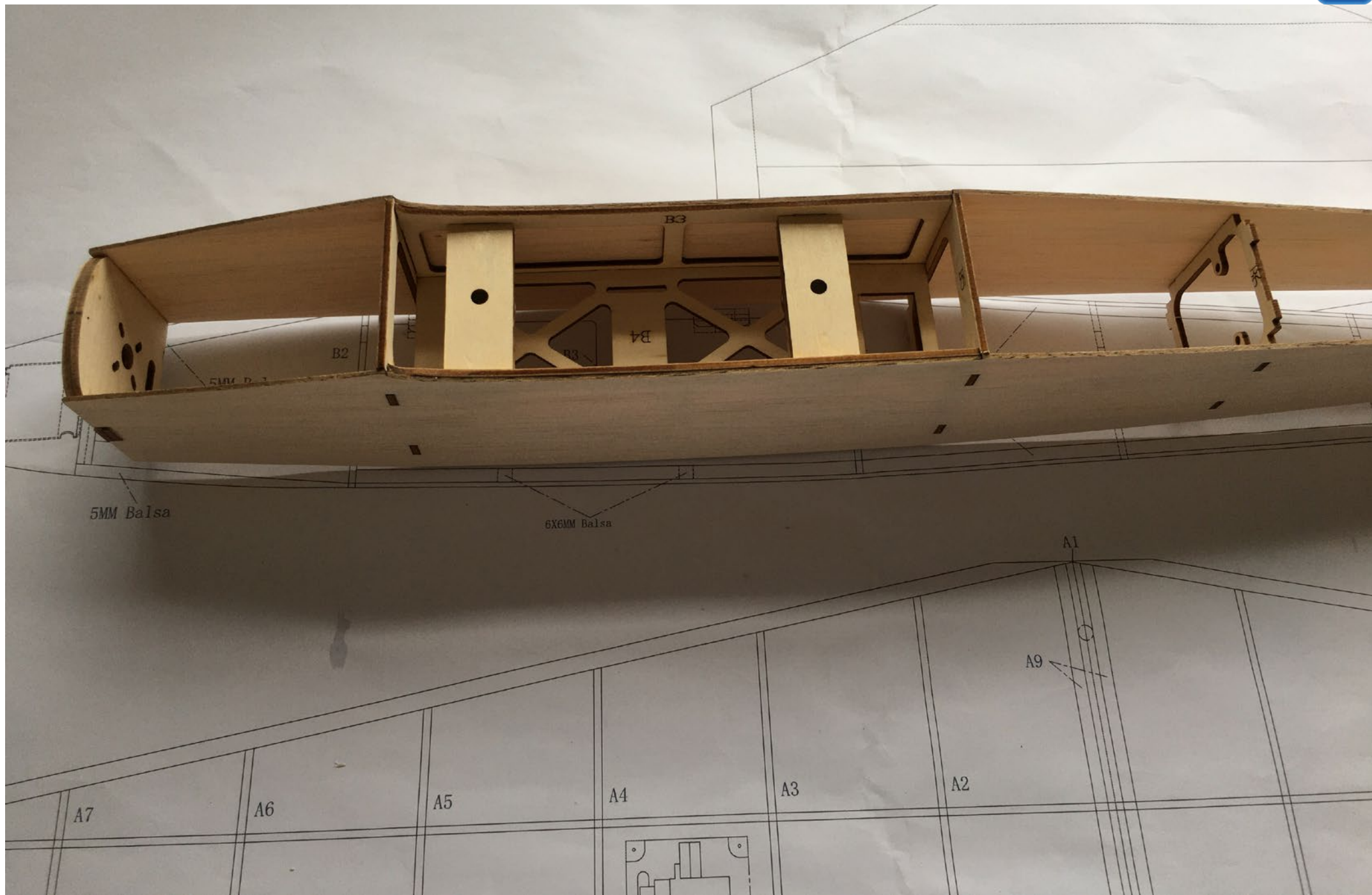

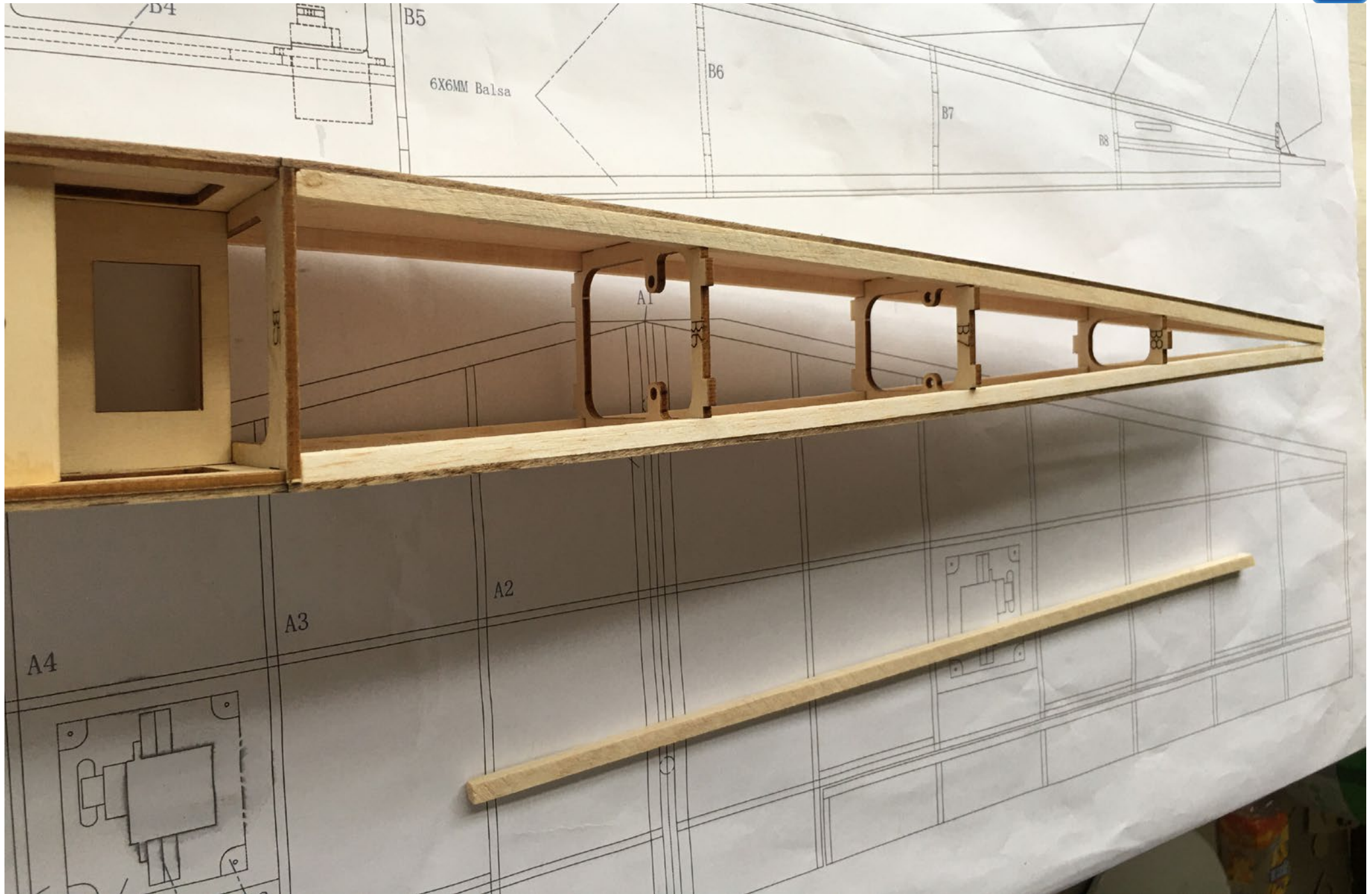





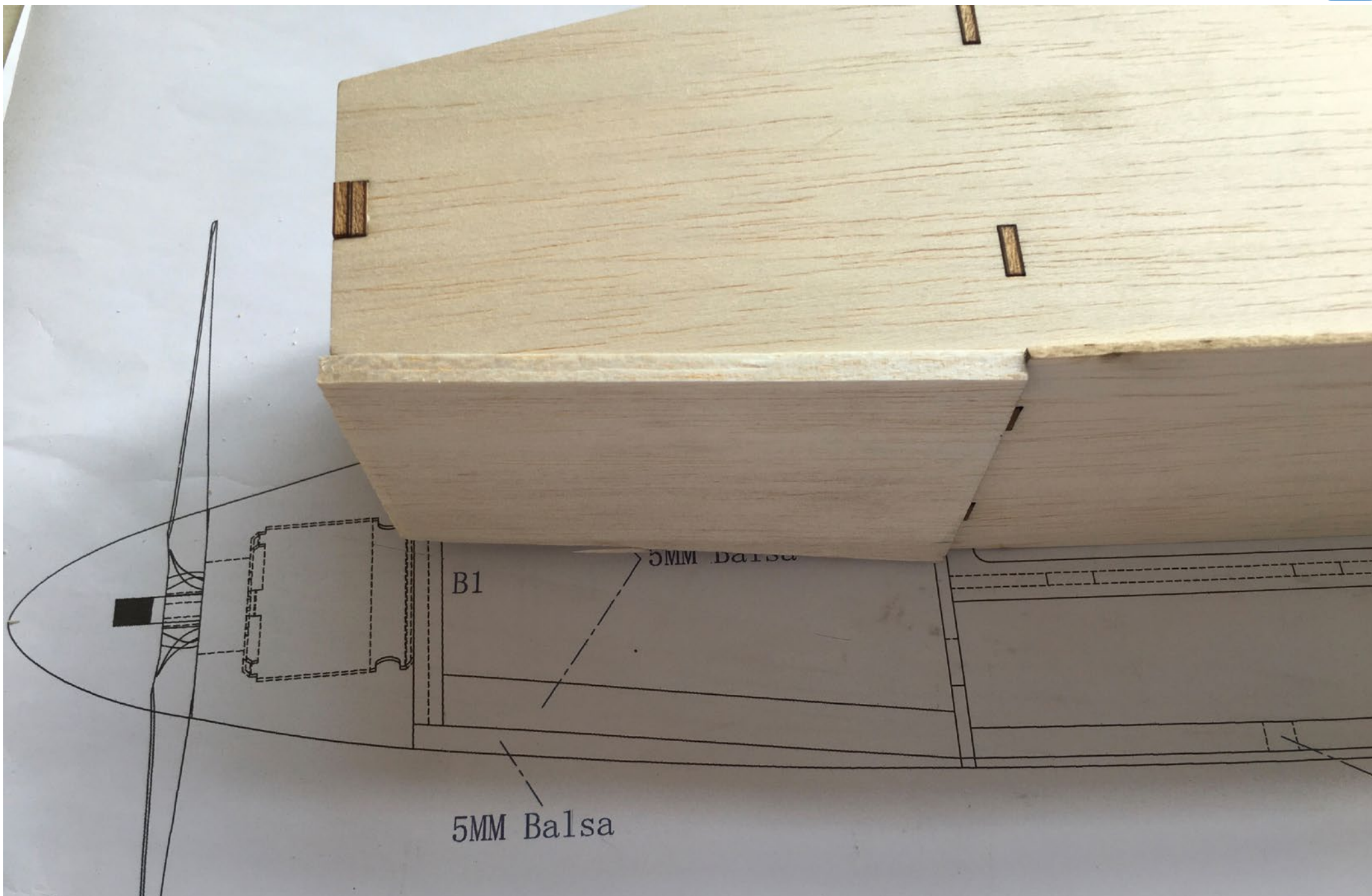



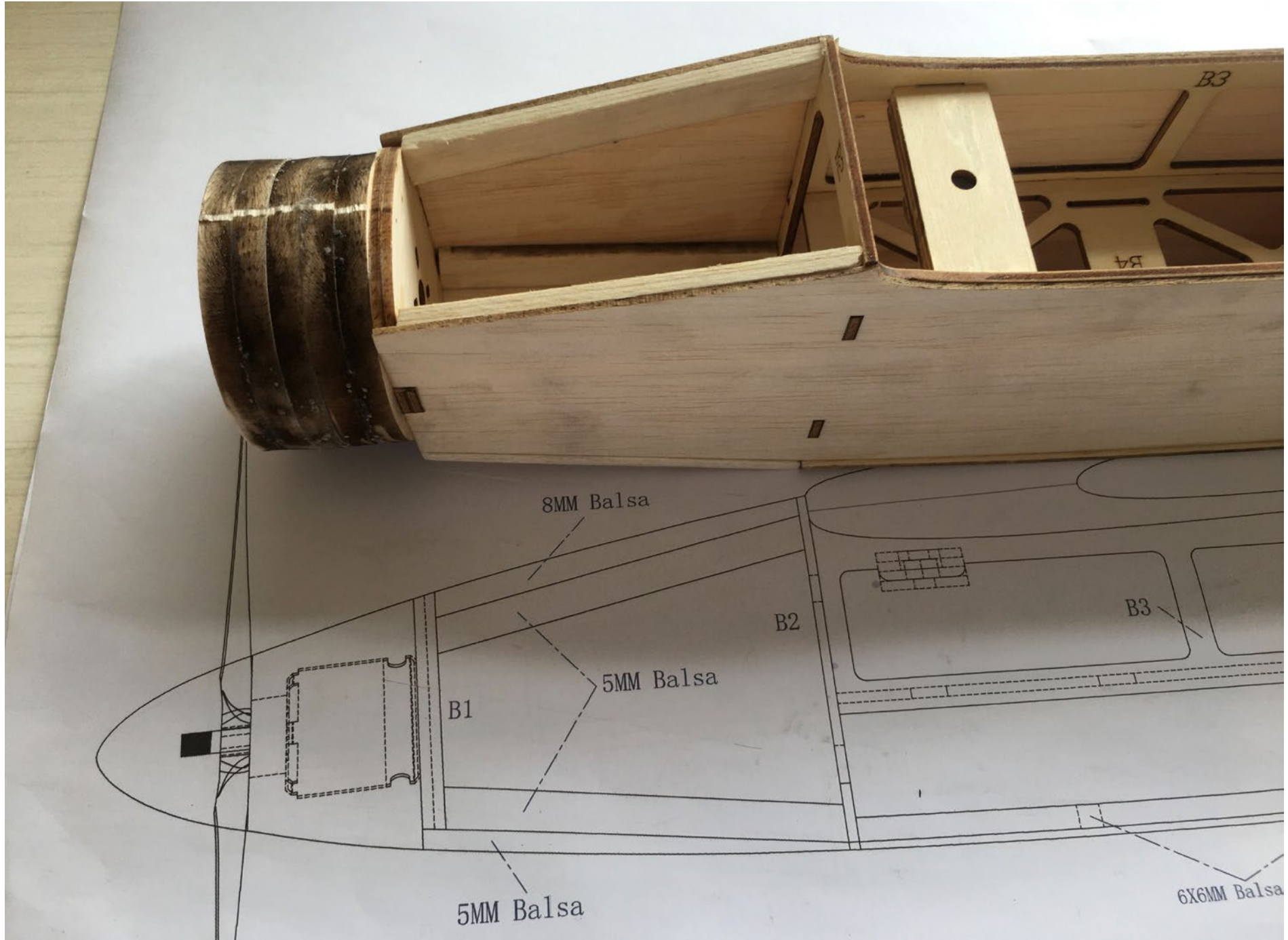



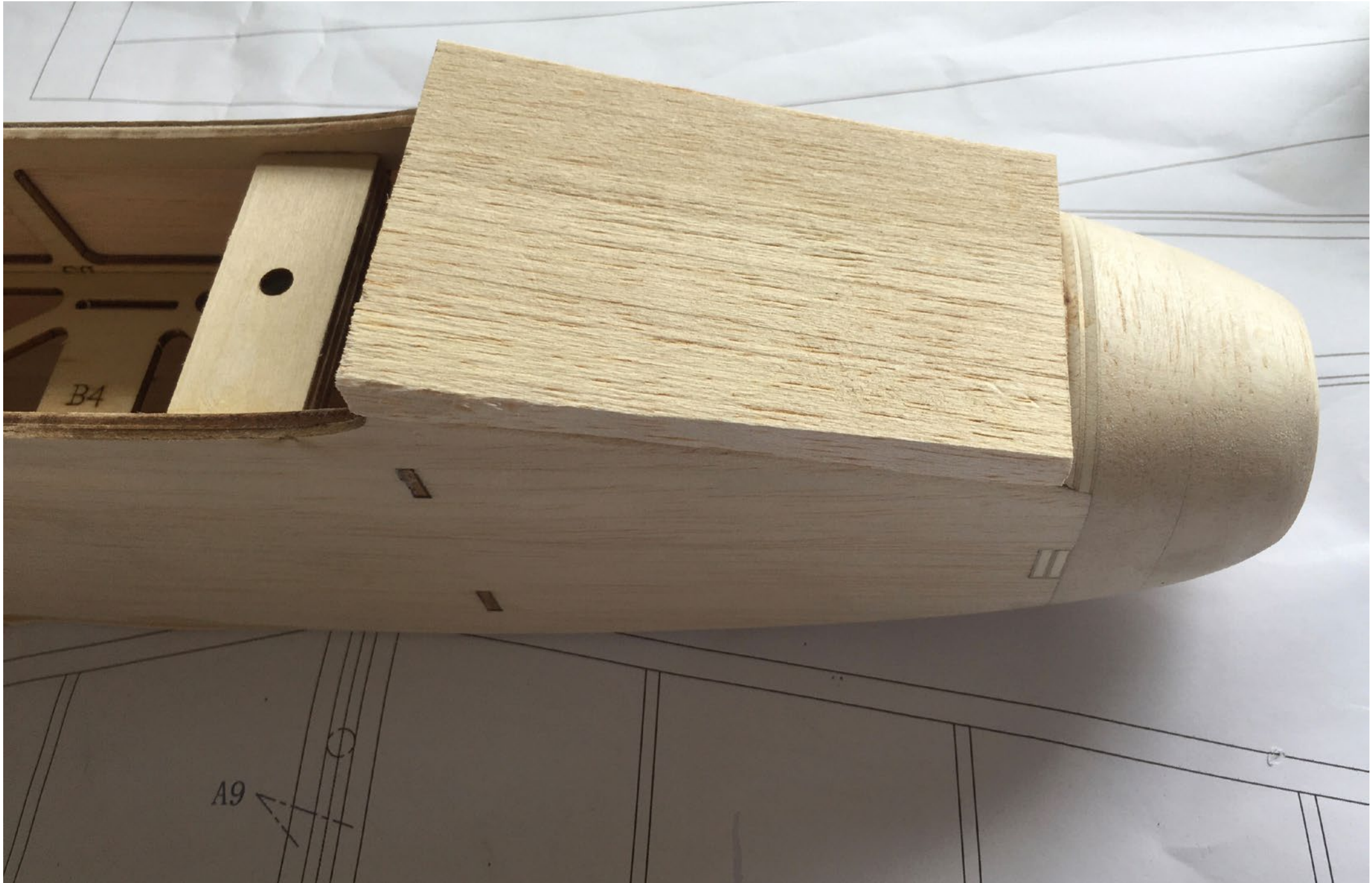







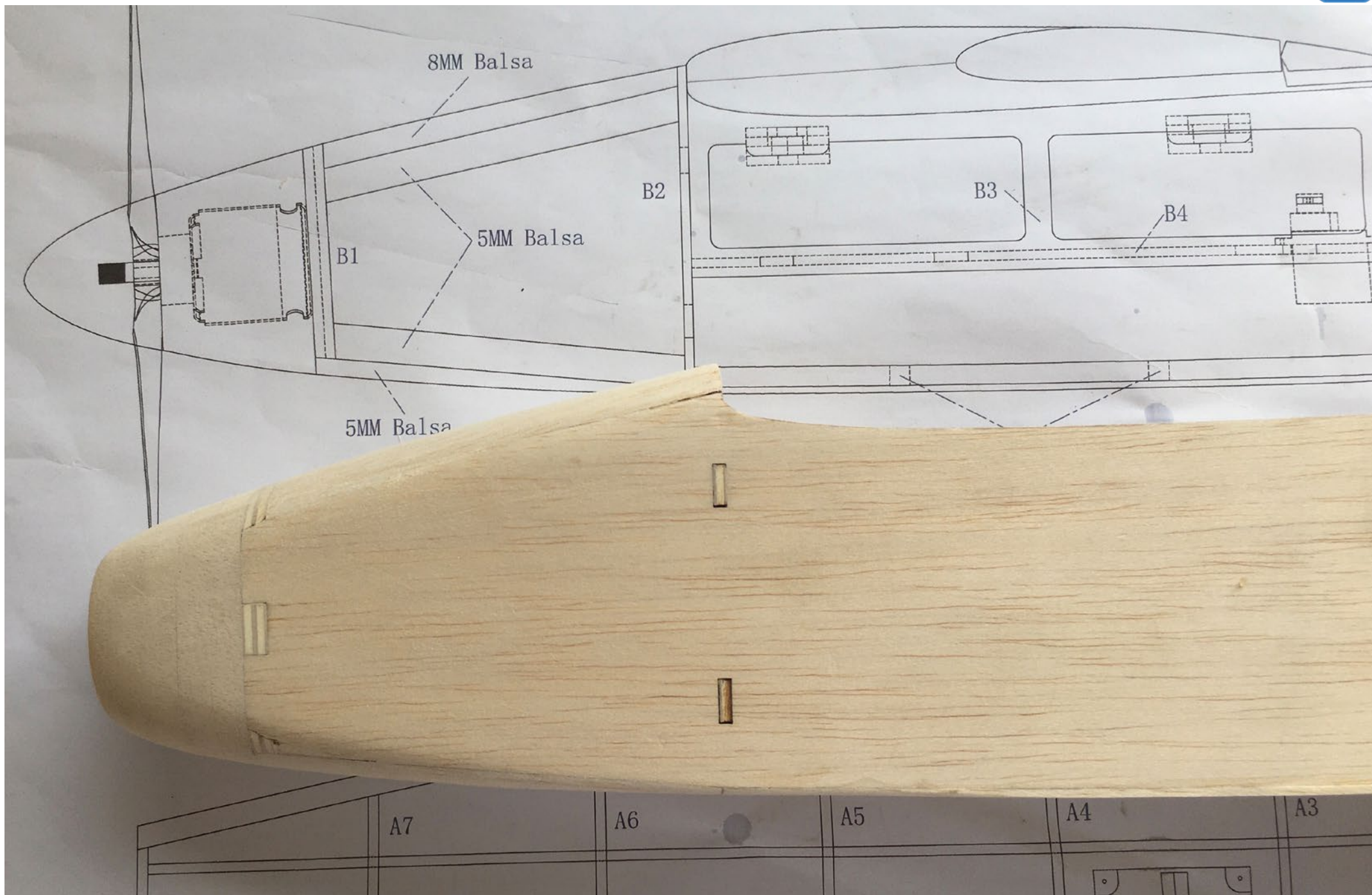











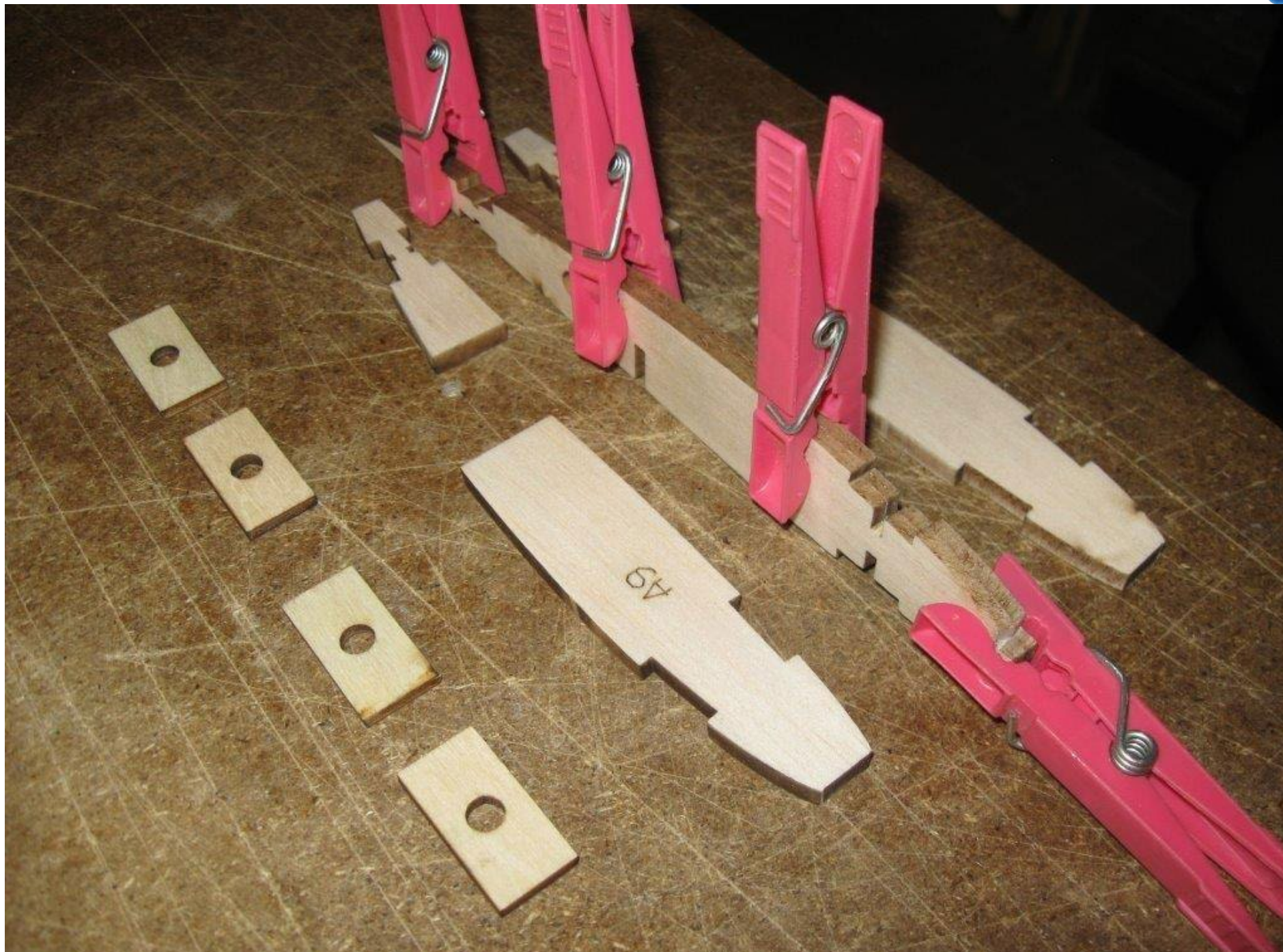

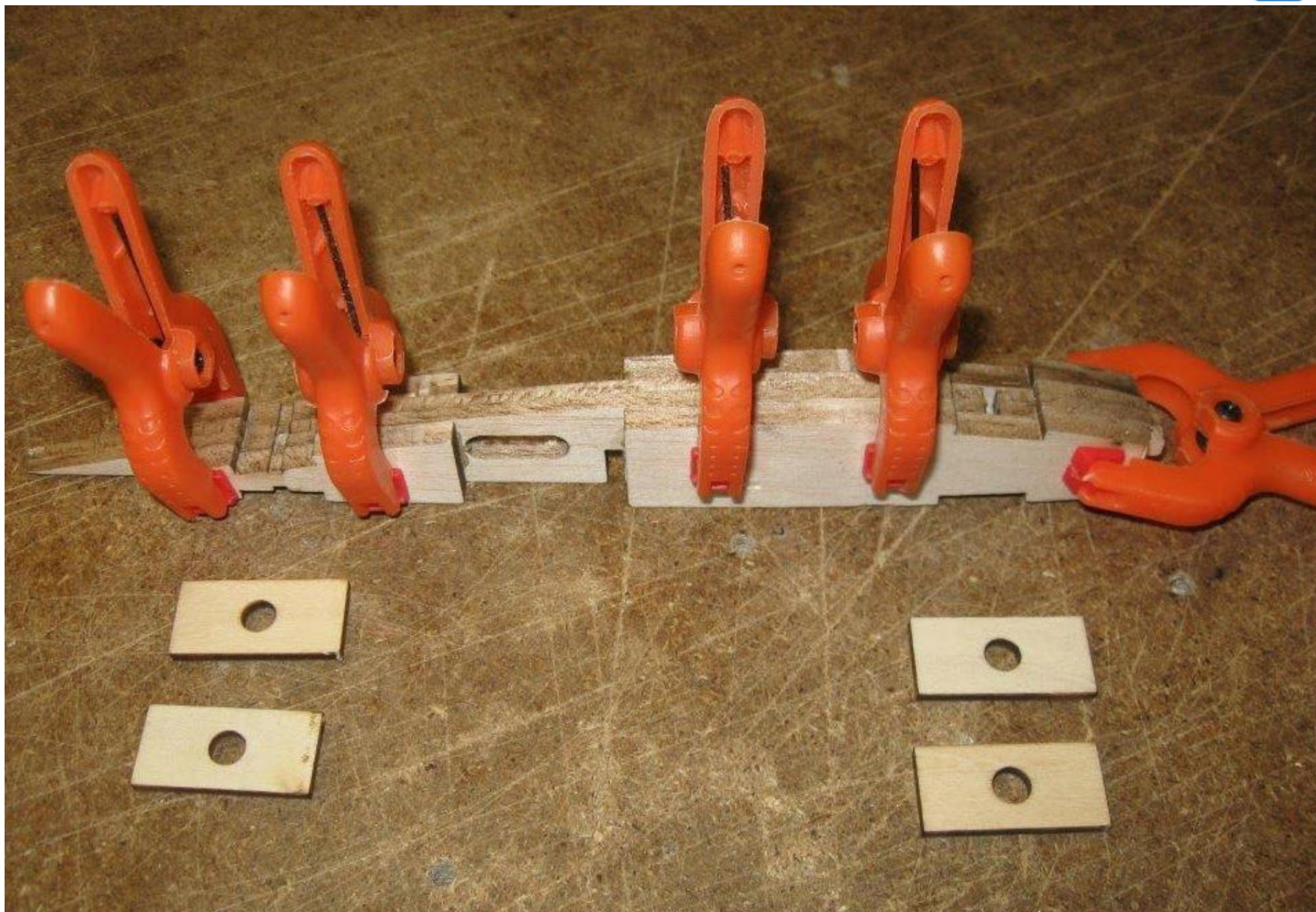

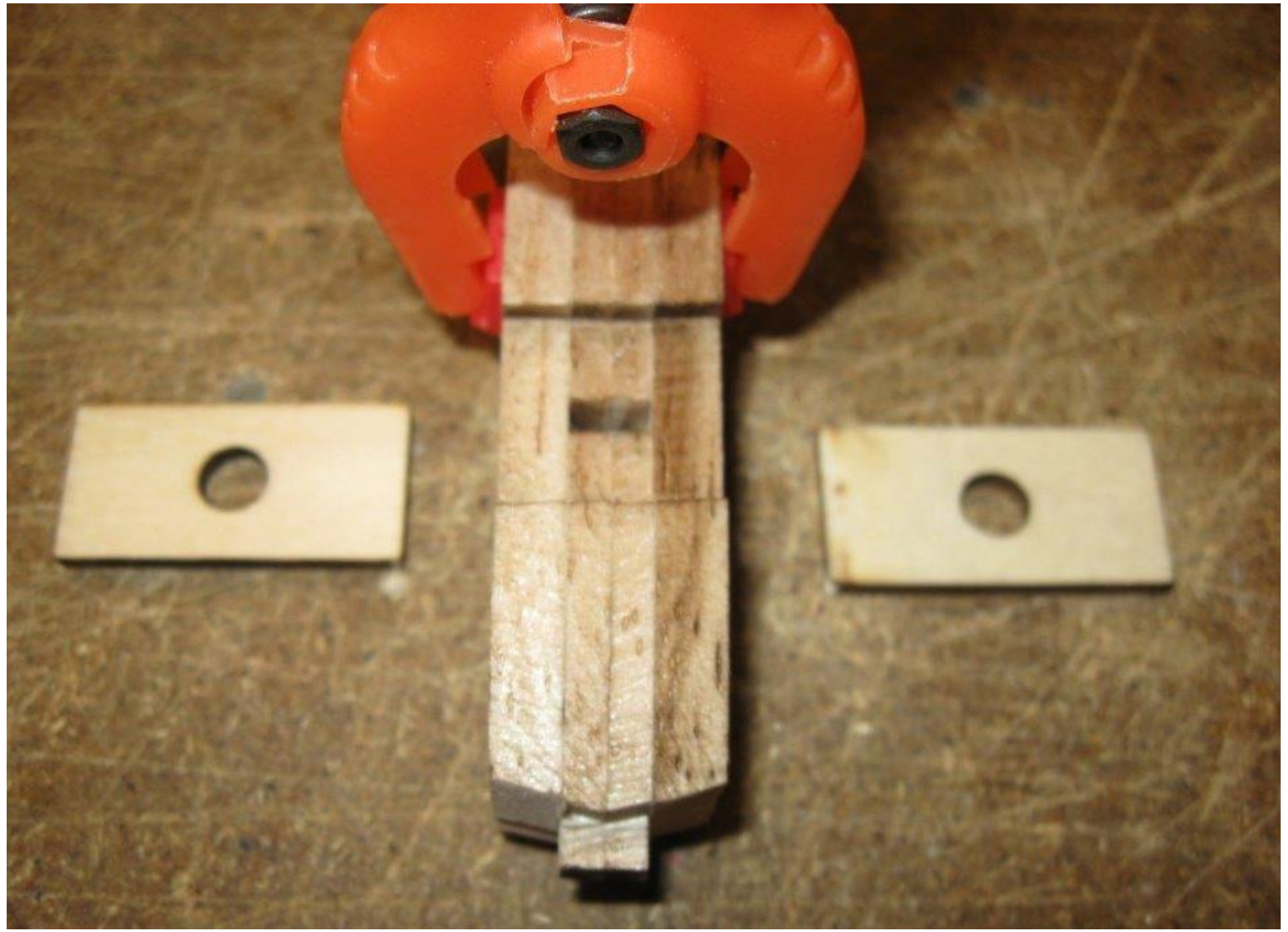

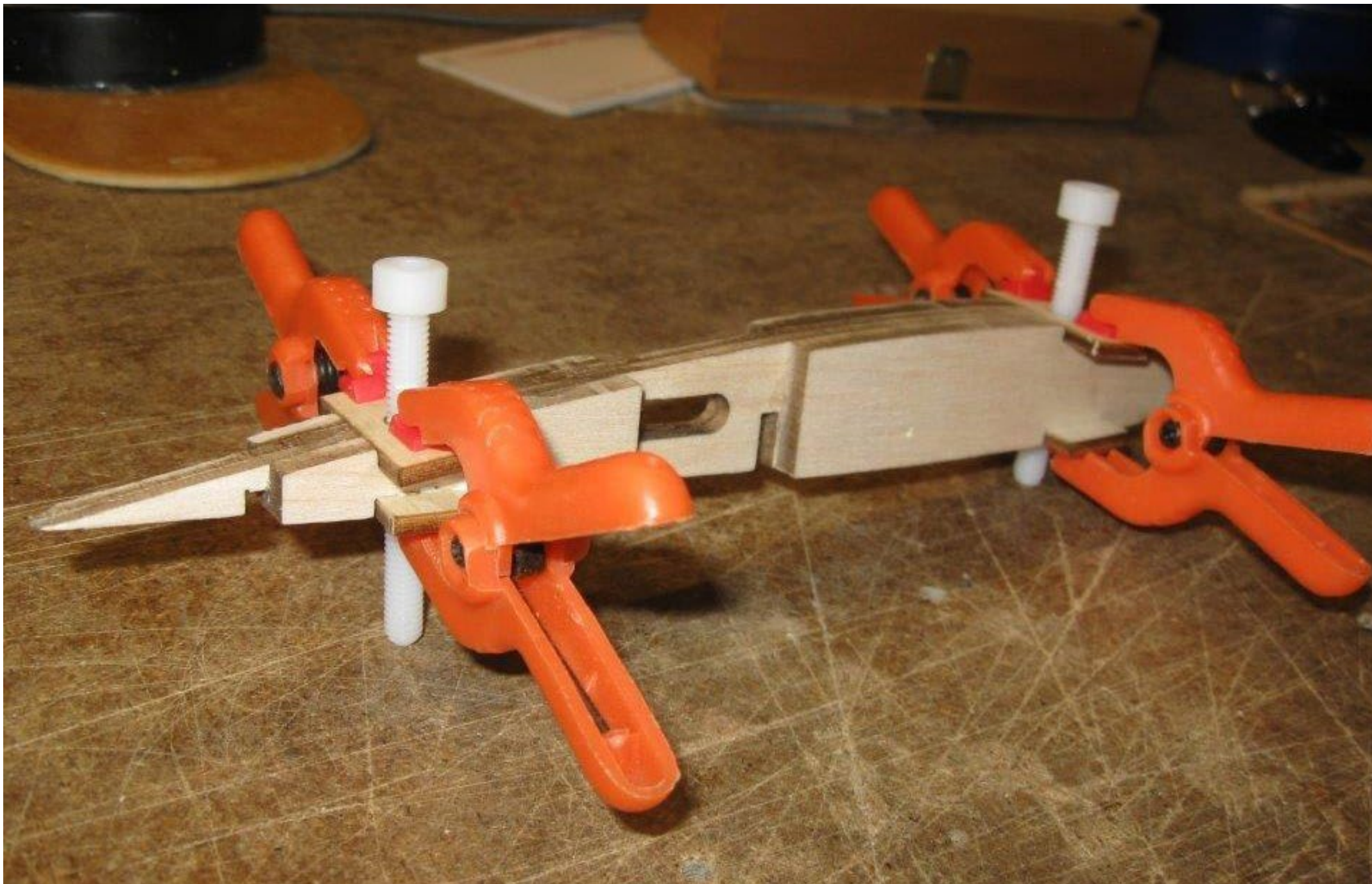

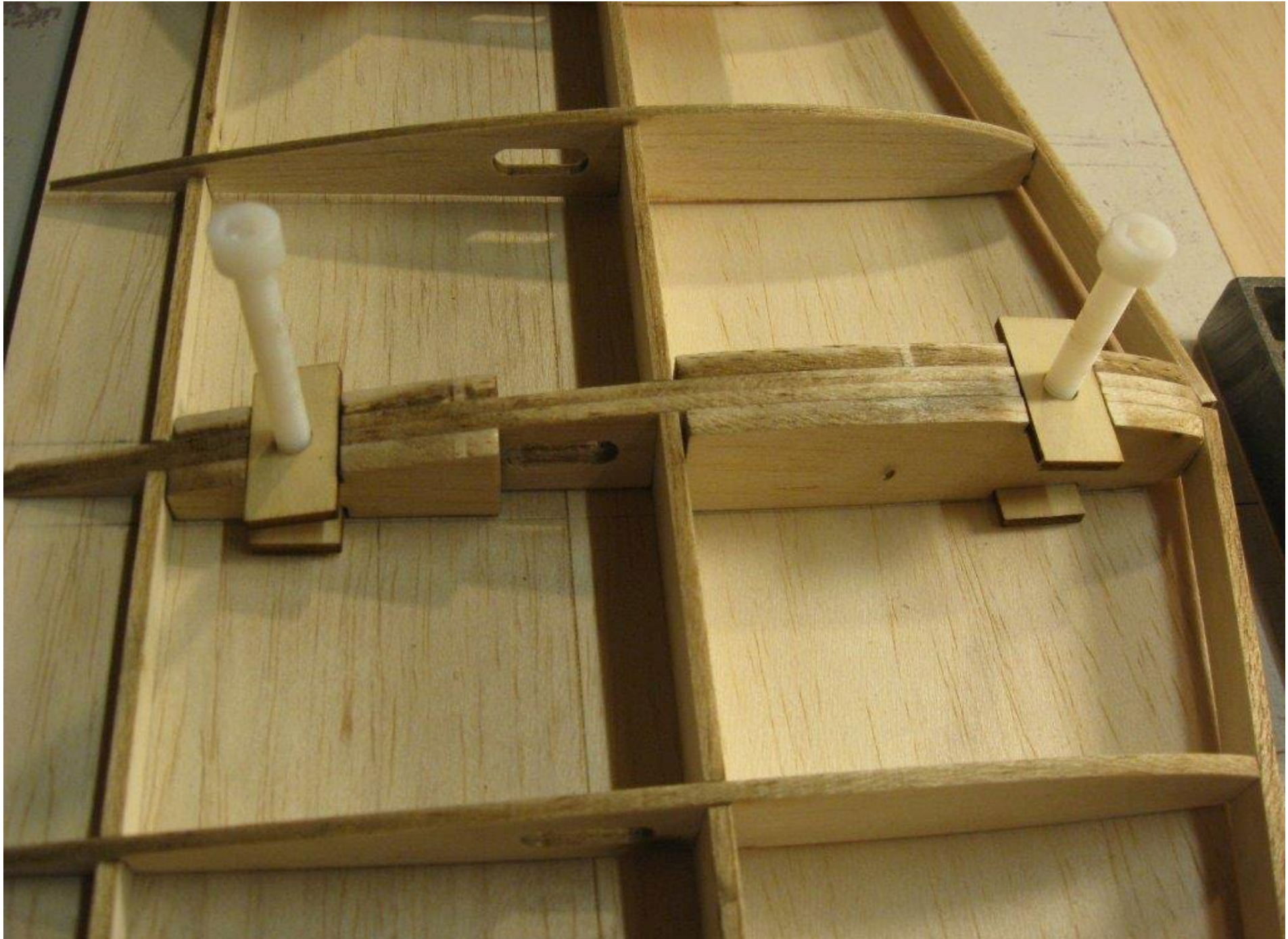



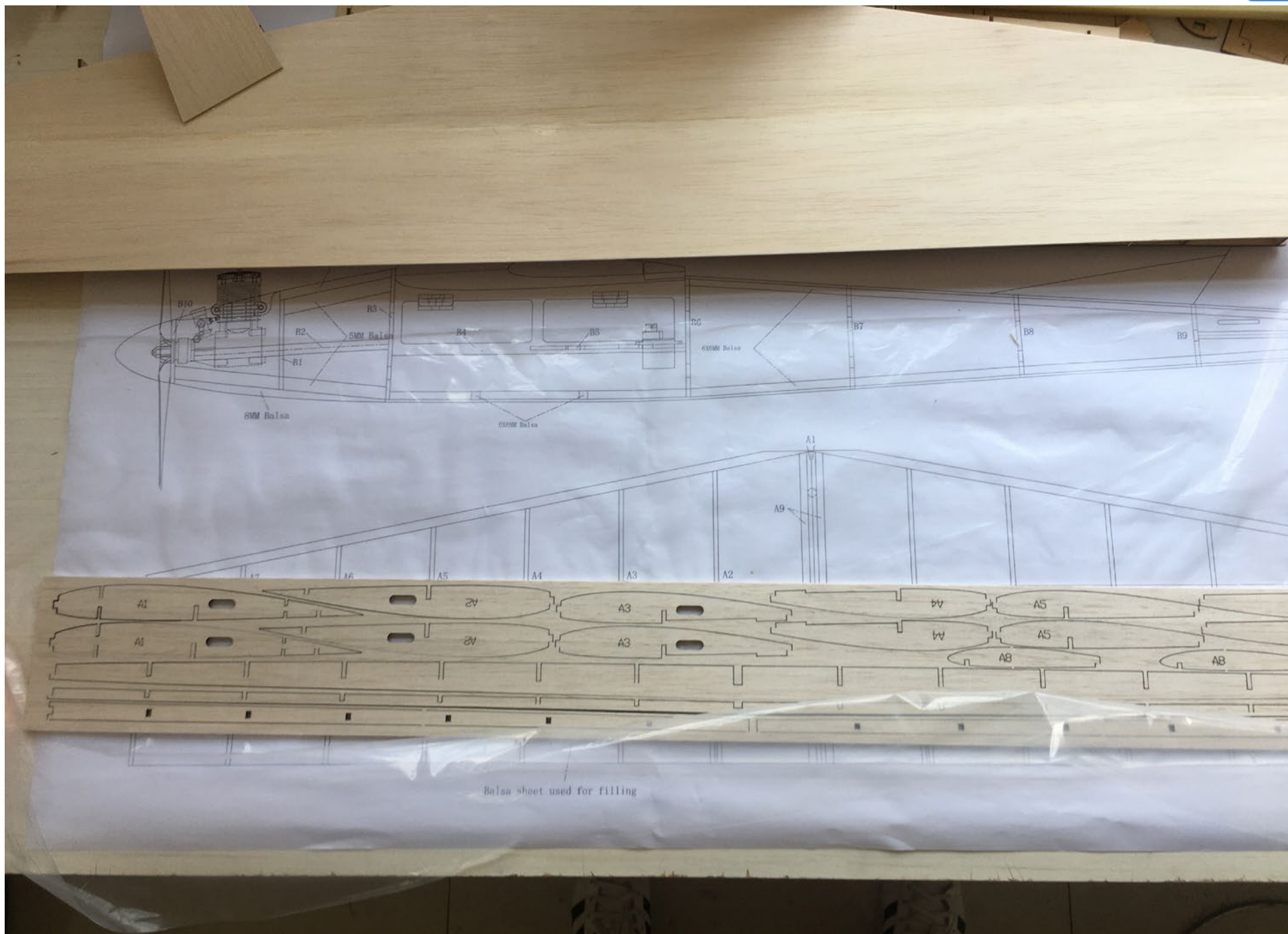



















used for filling

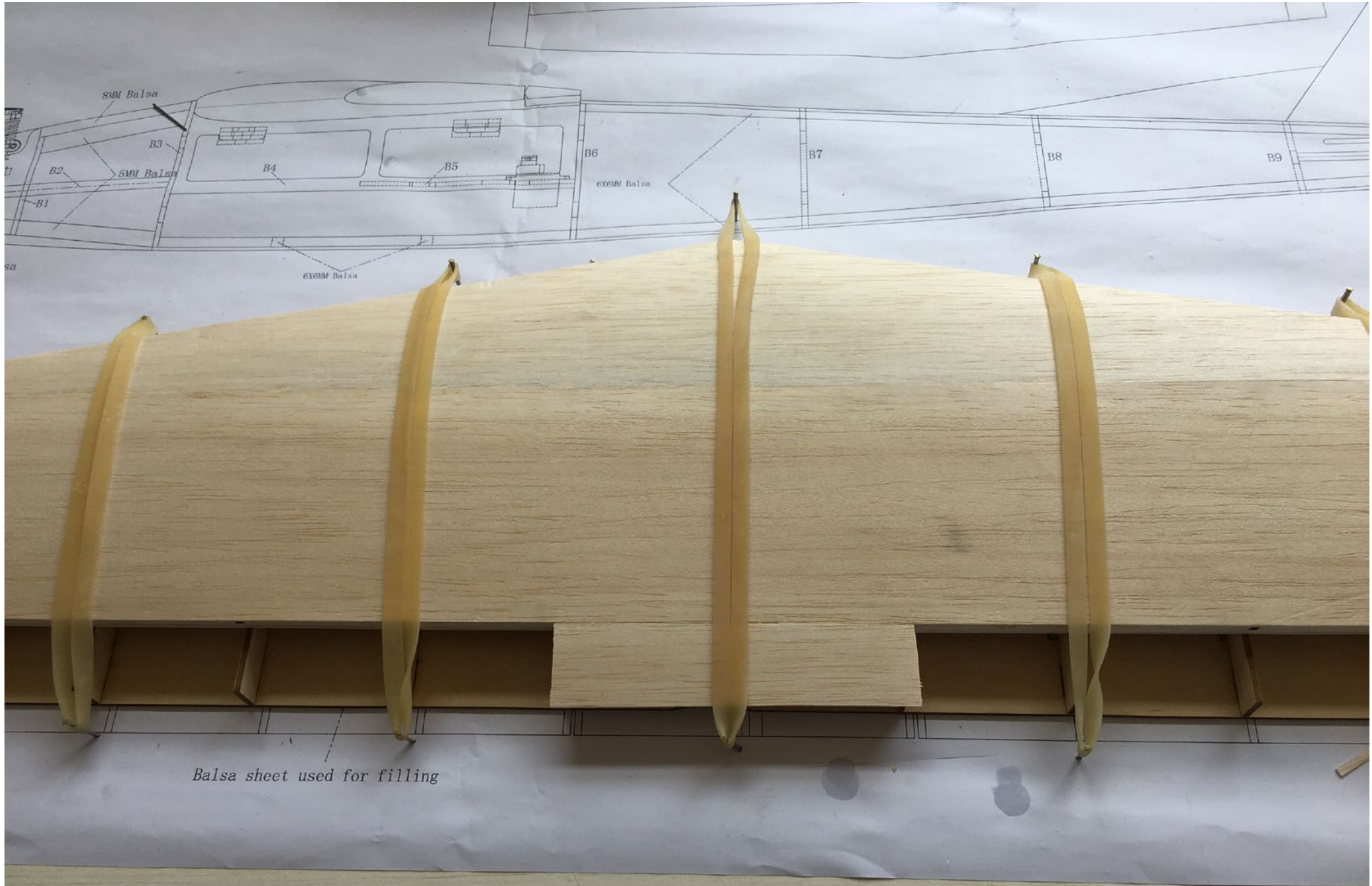





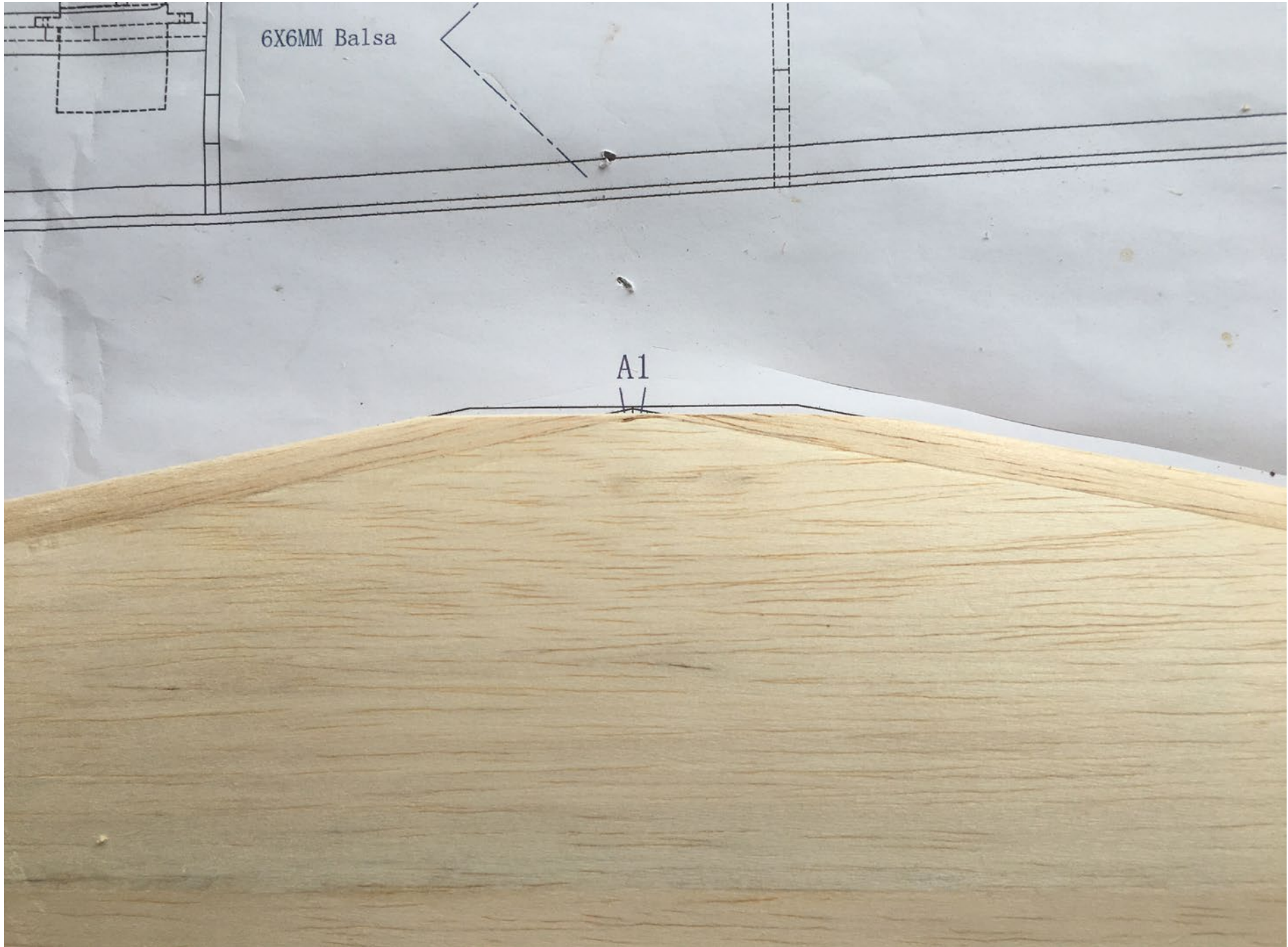

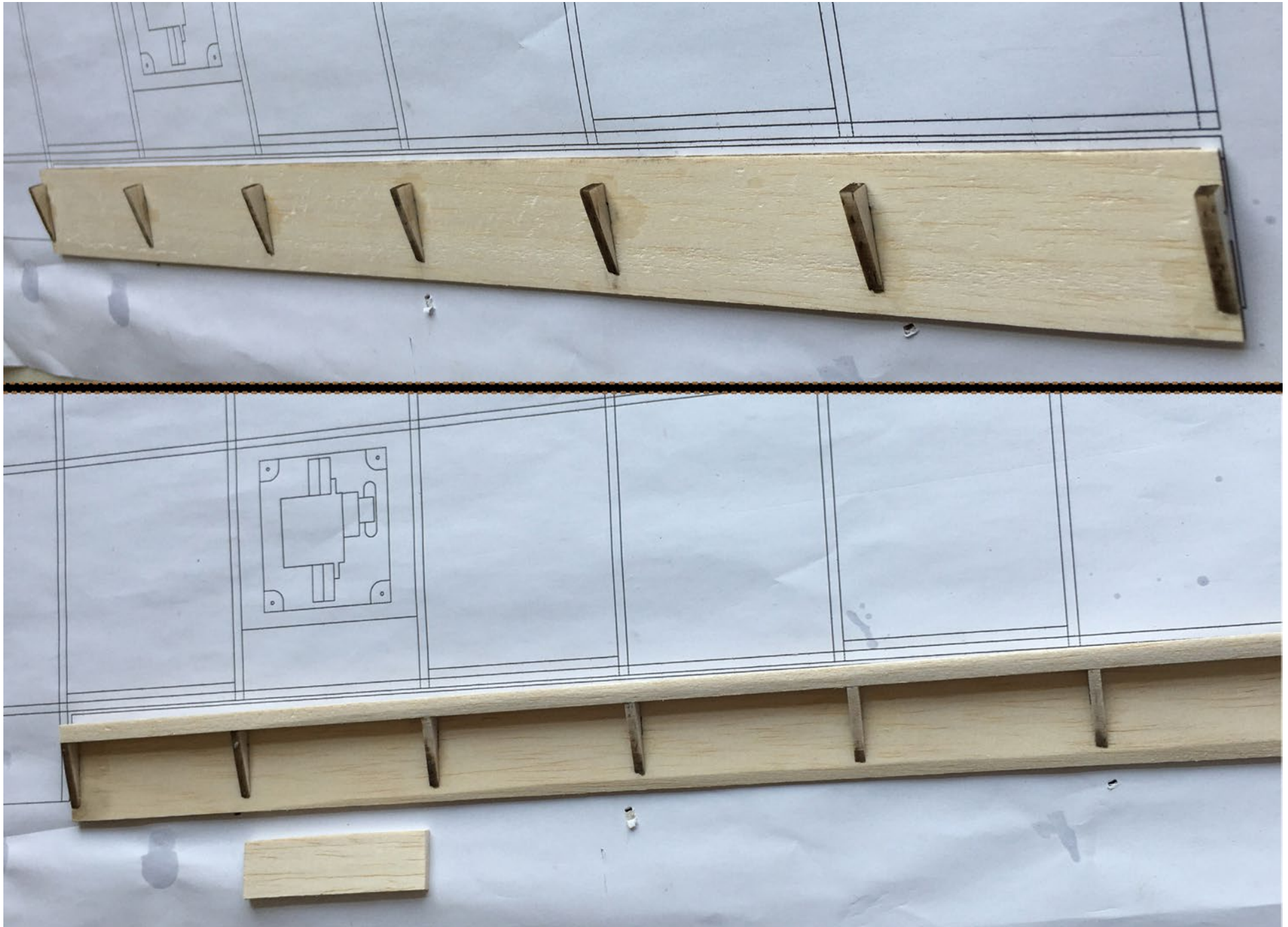

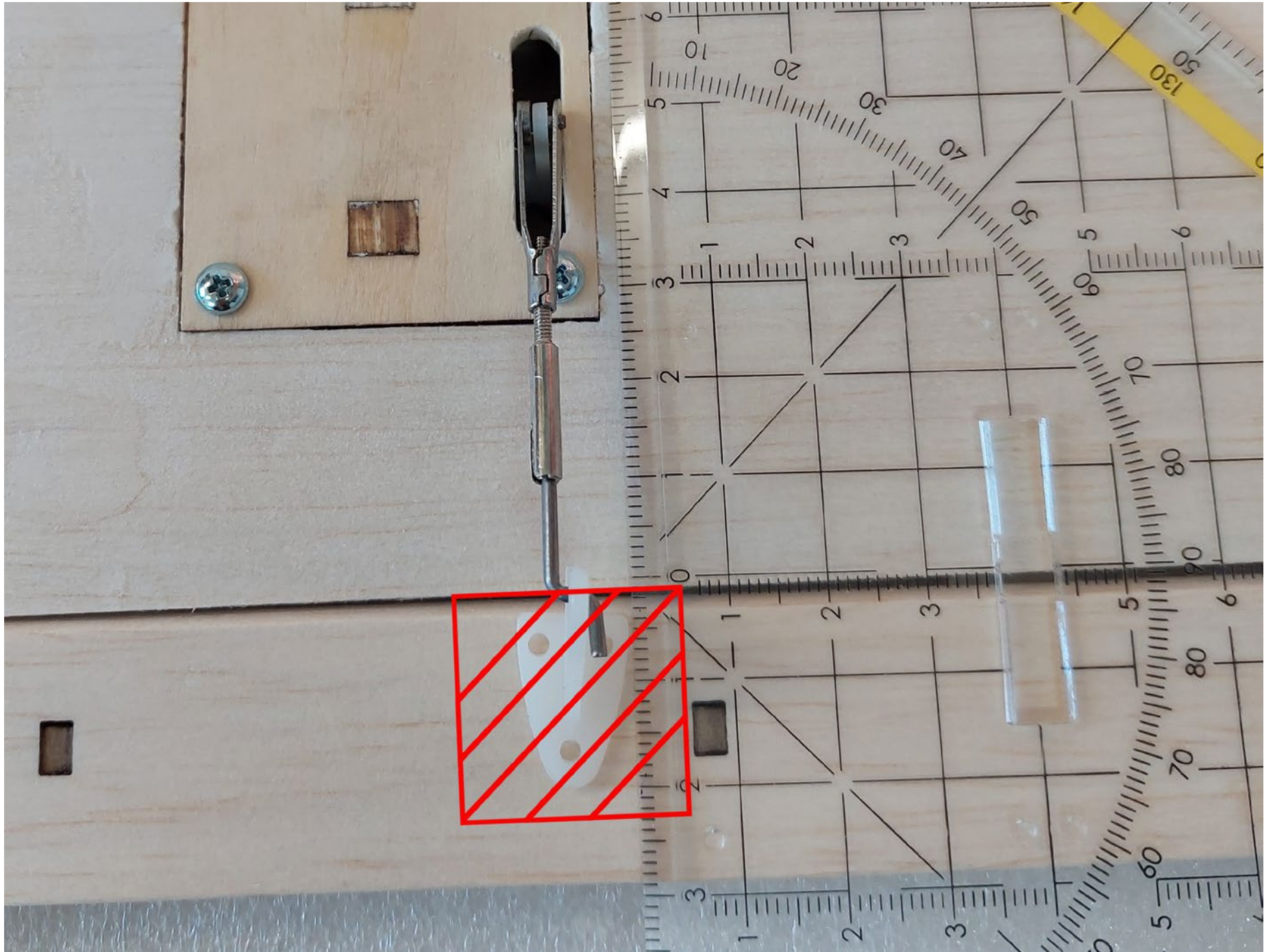

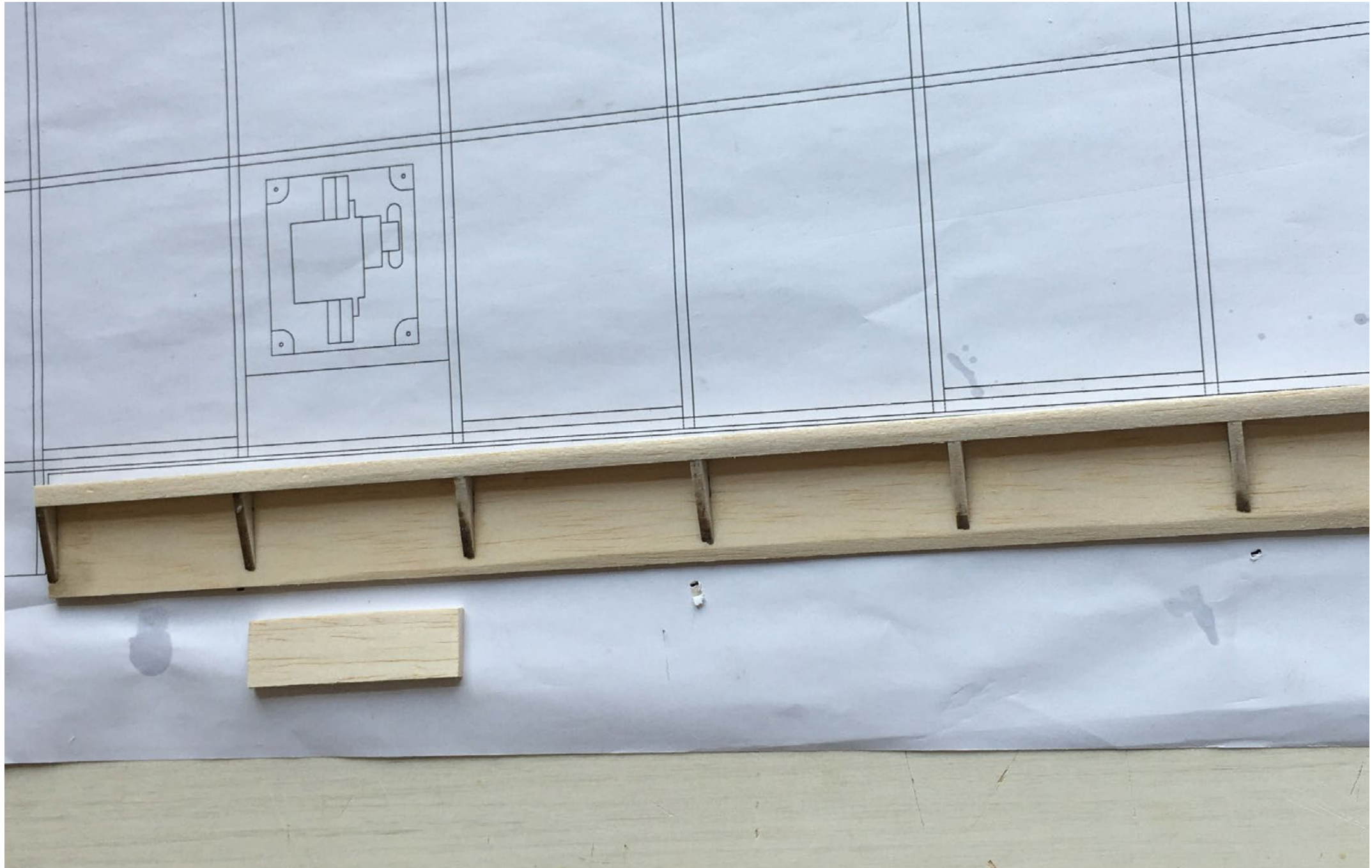







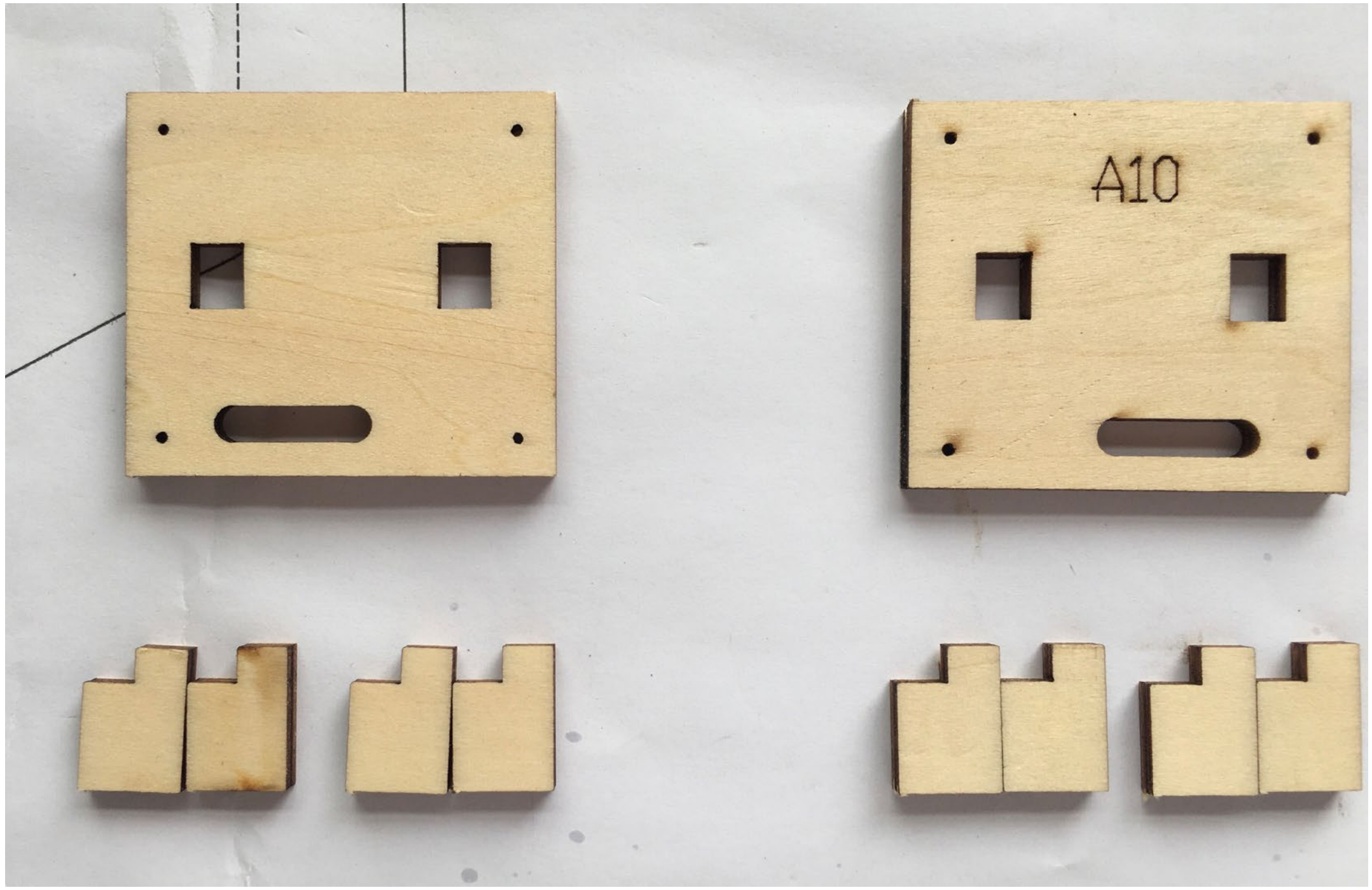

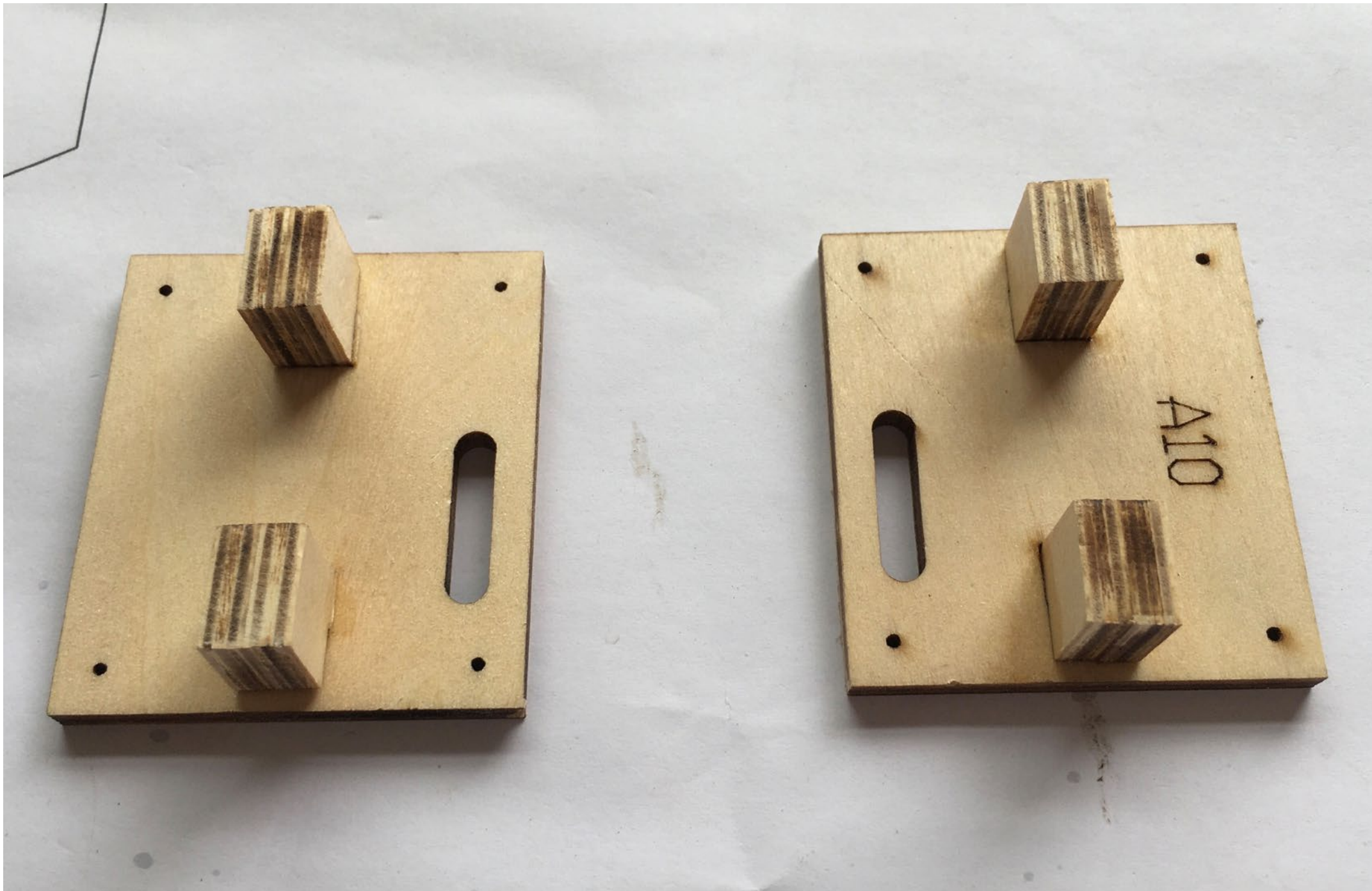















← robbe





← **robbe**









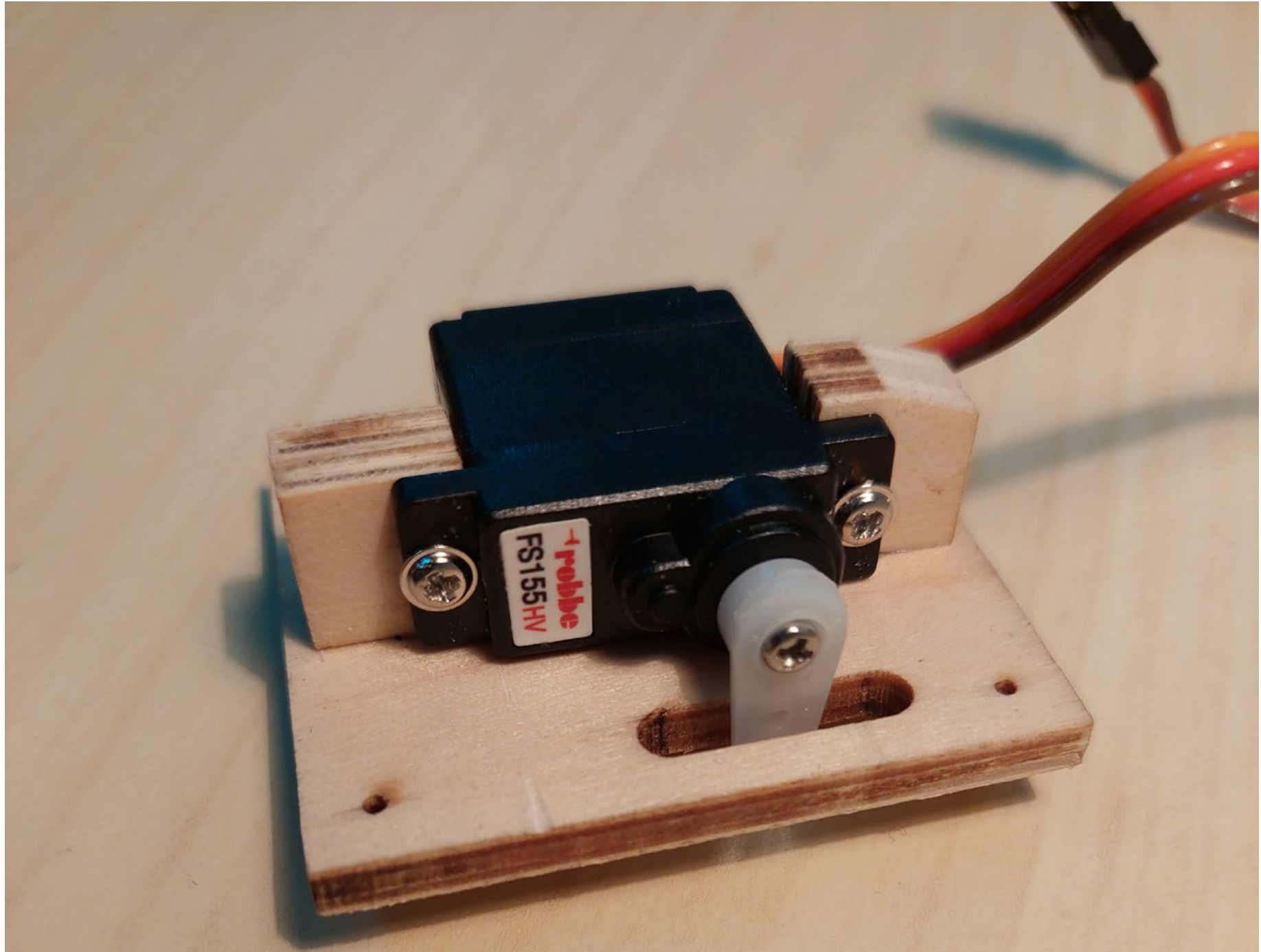

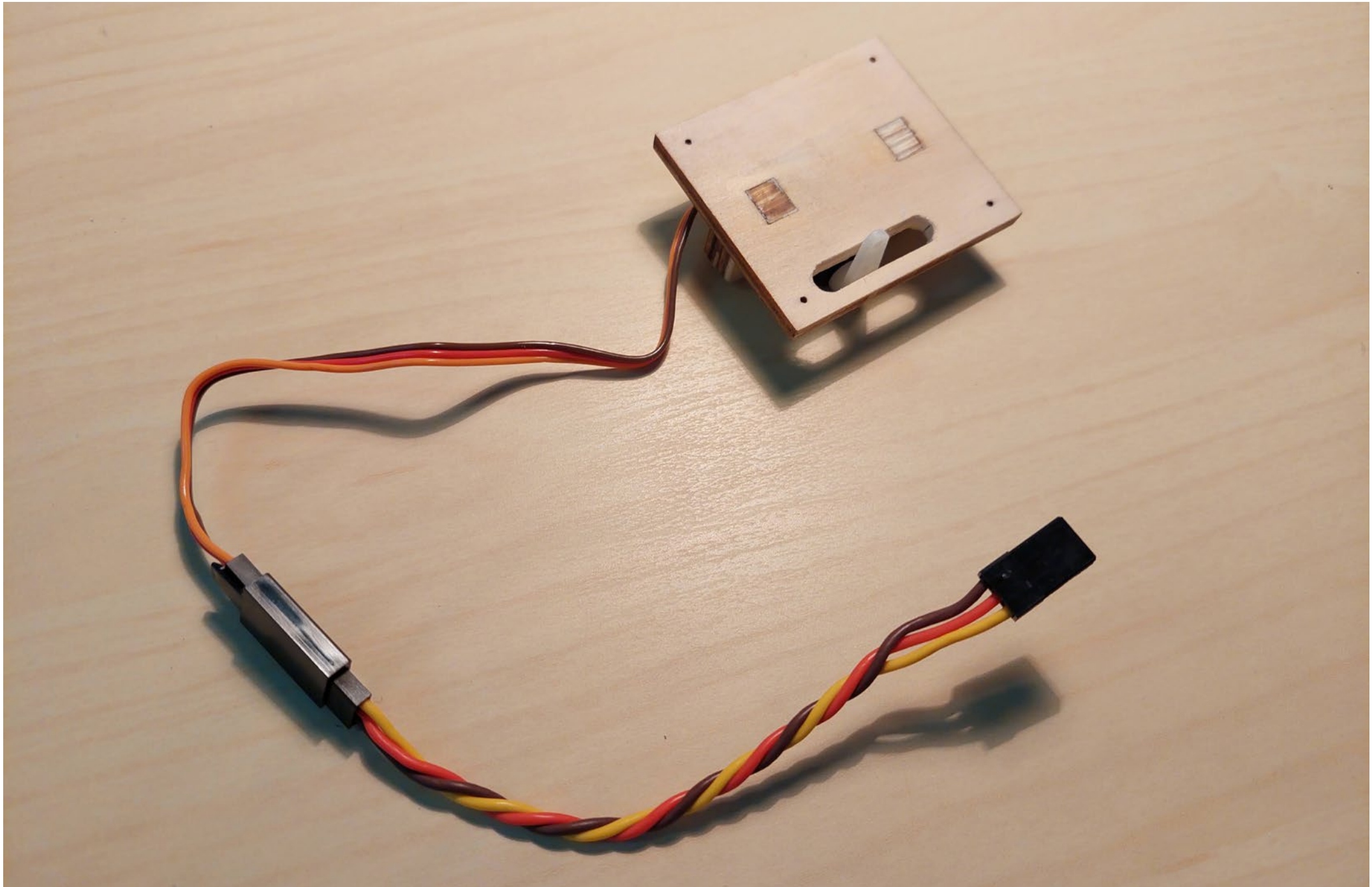





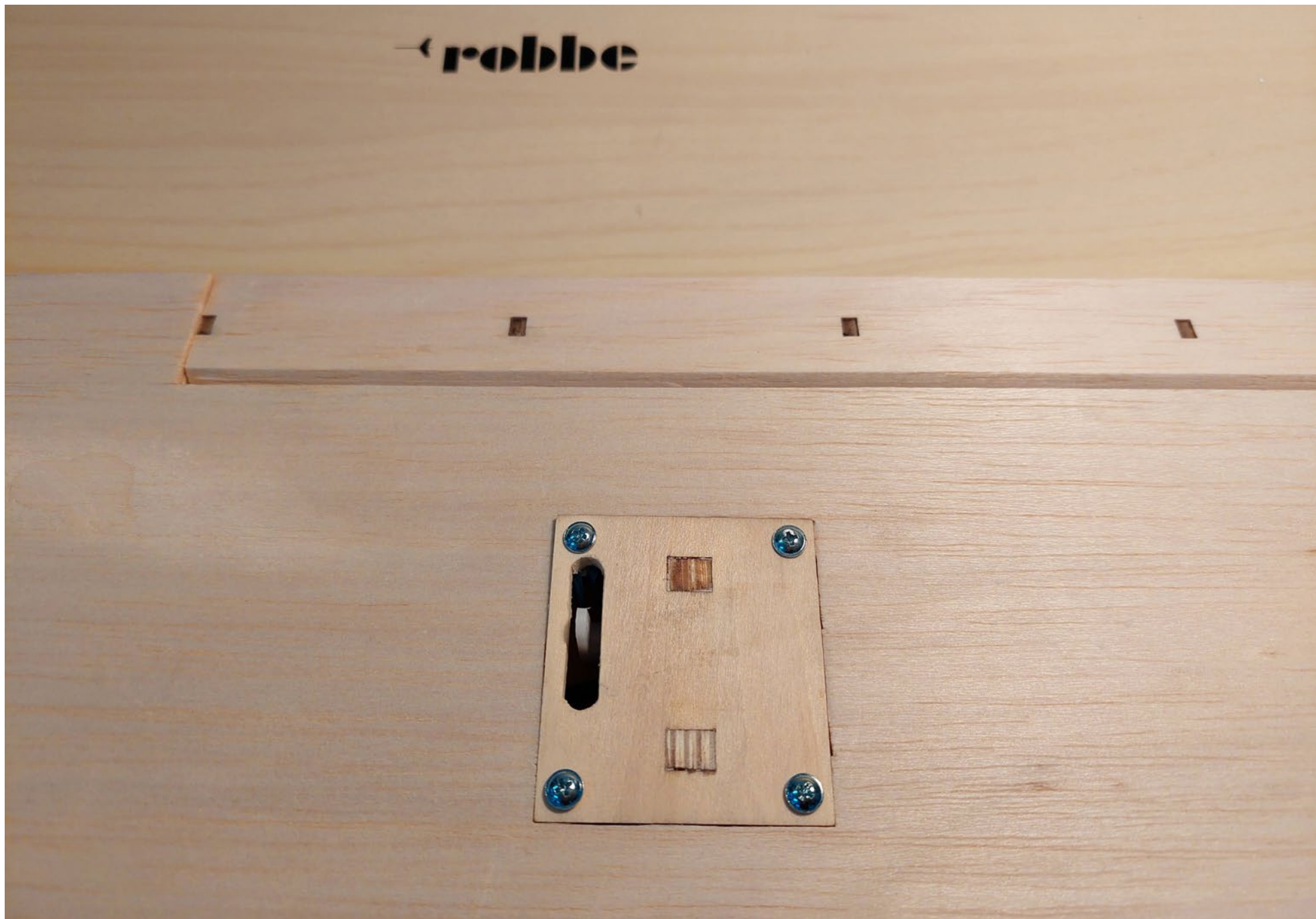

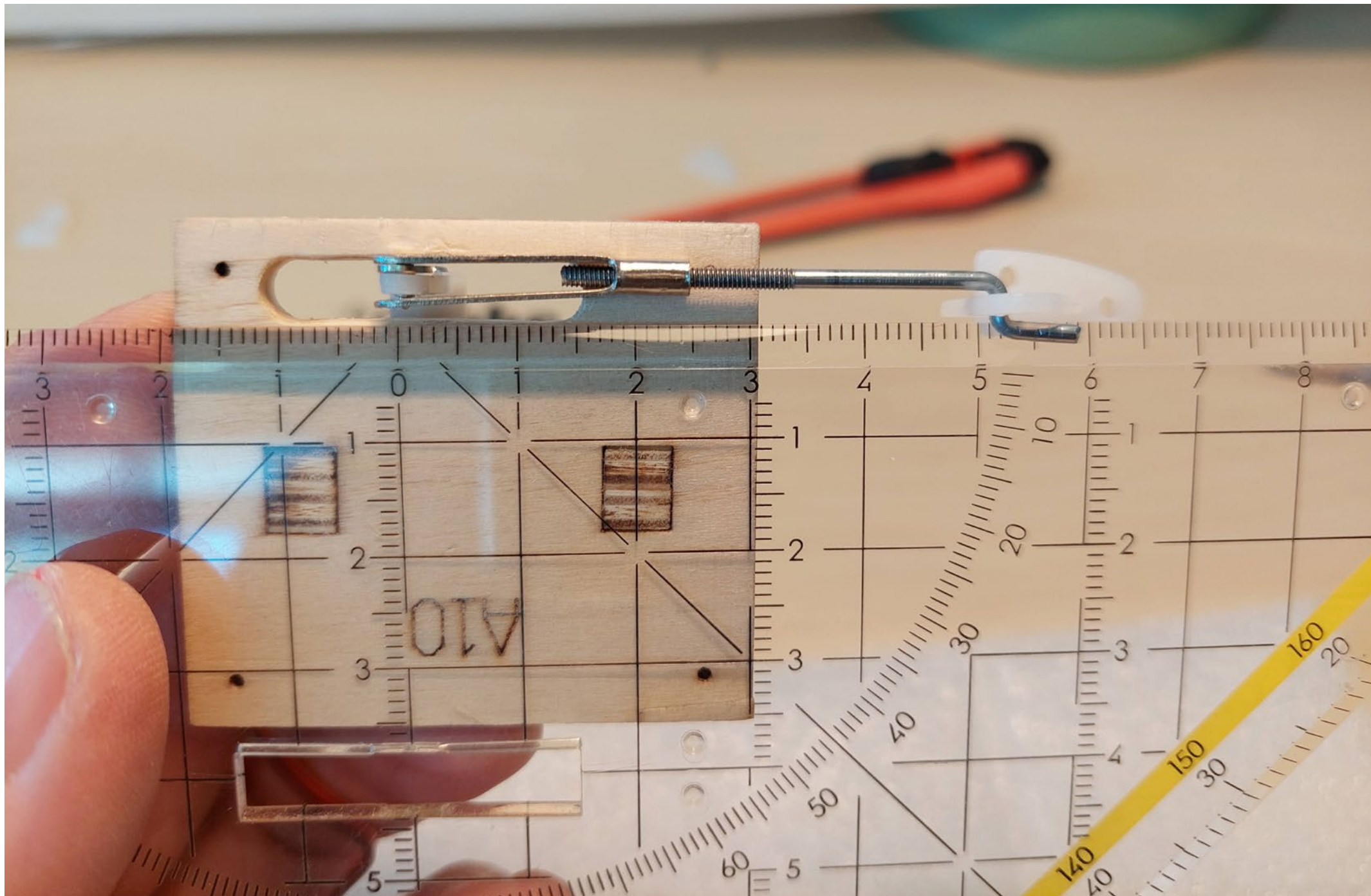





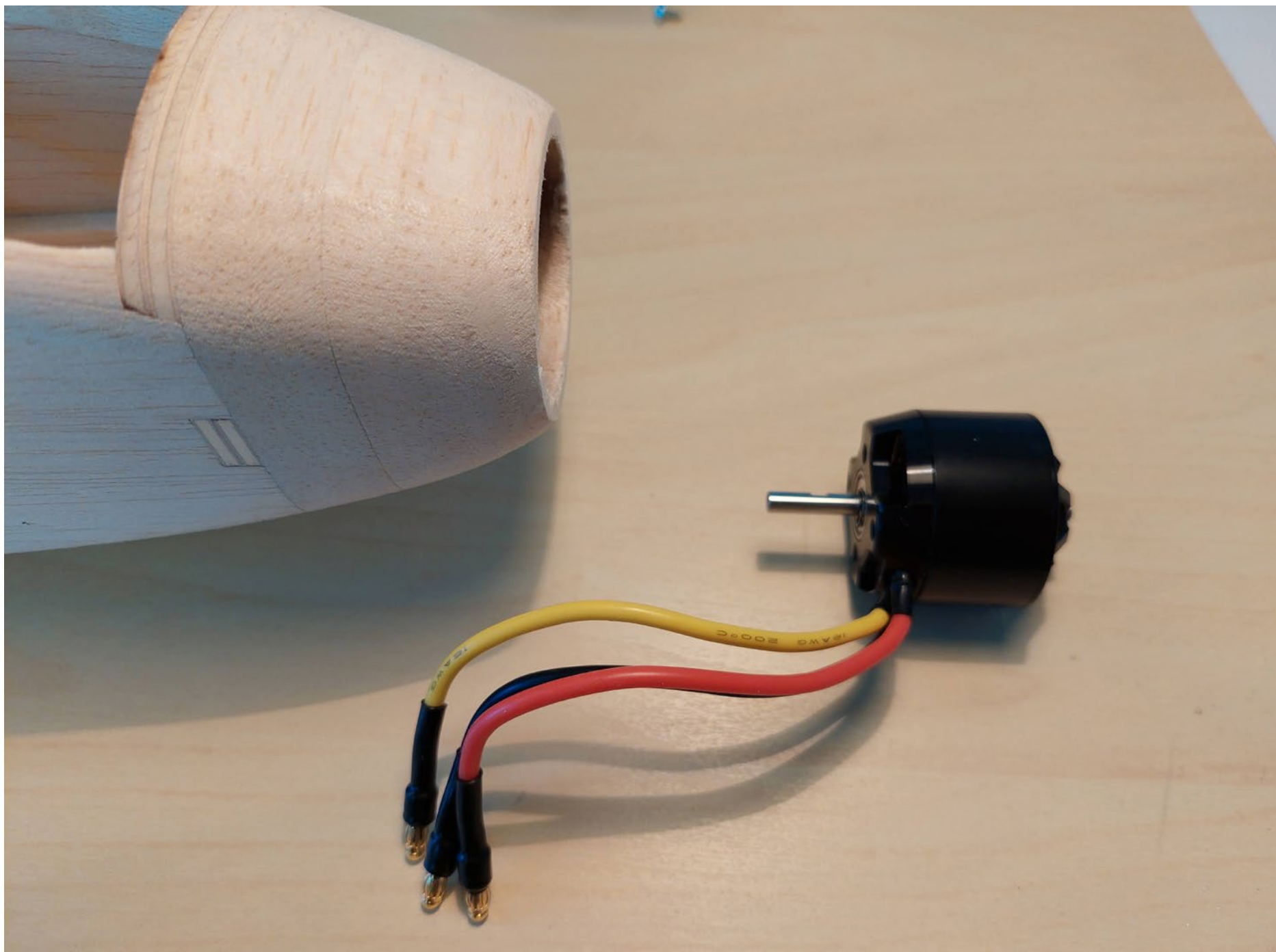

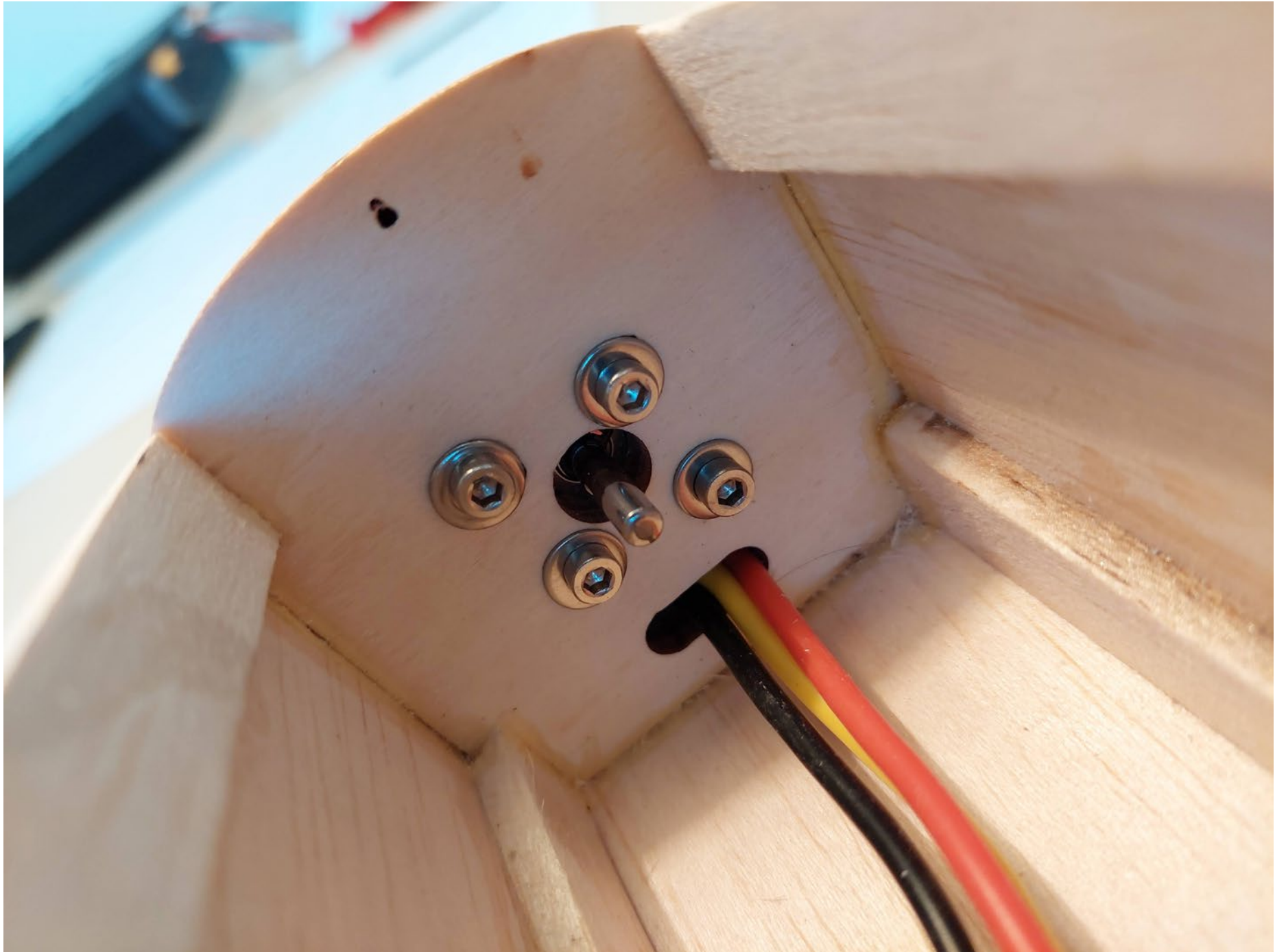





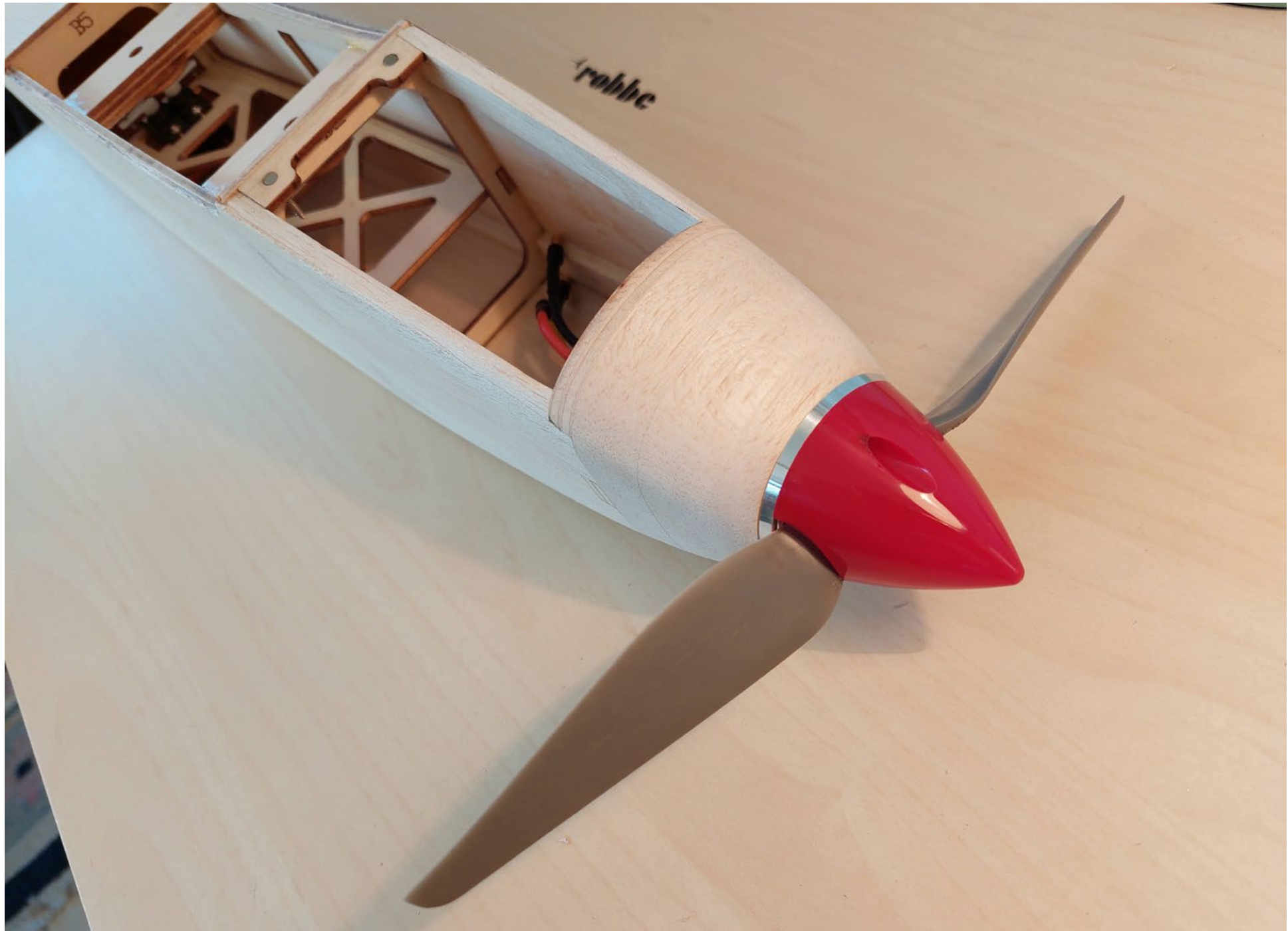



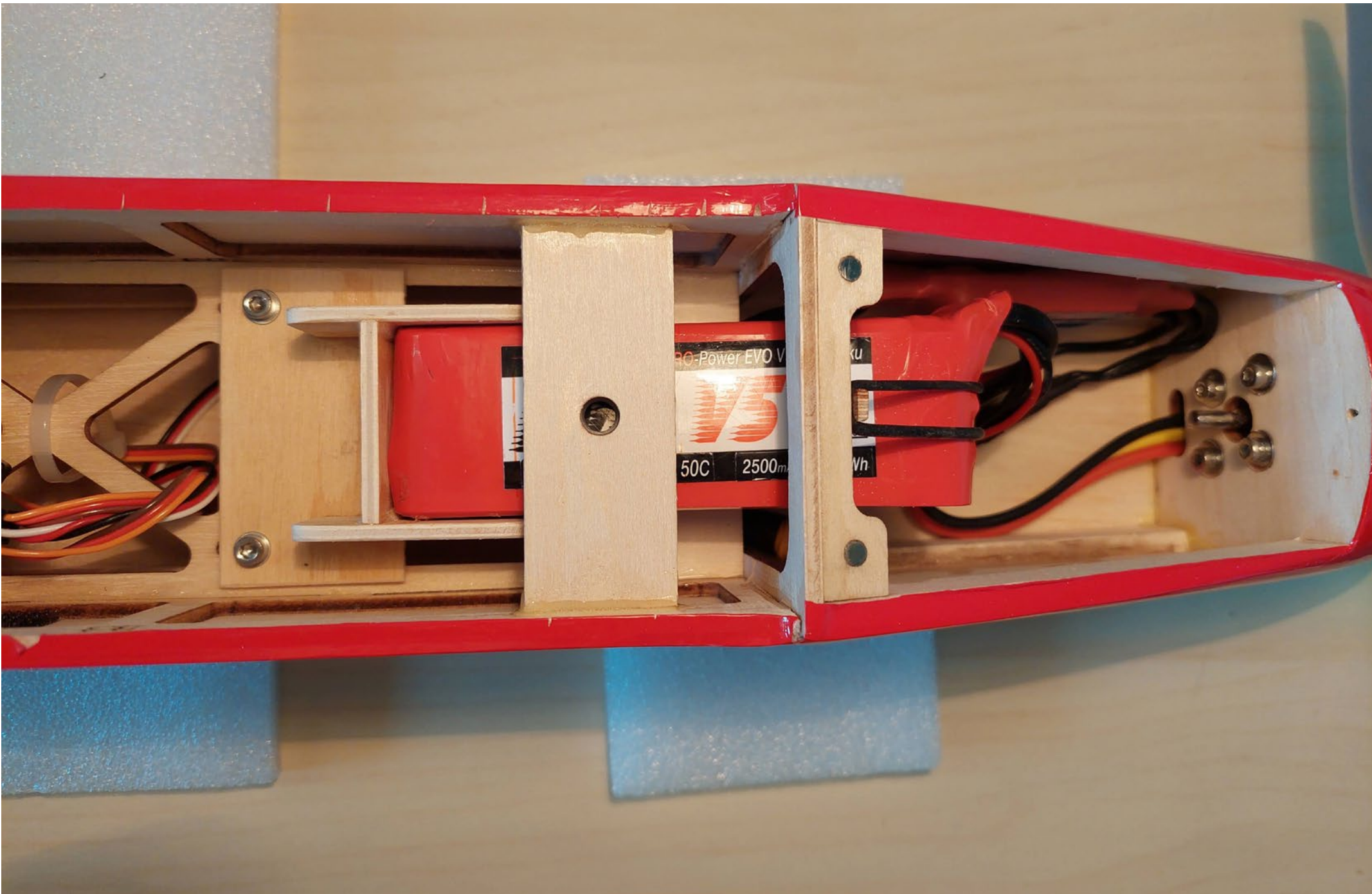



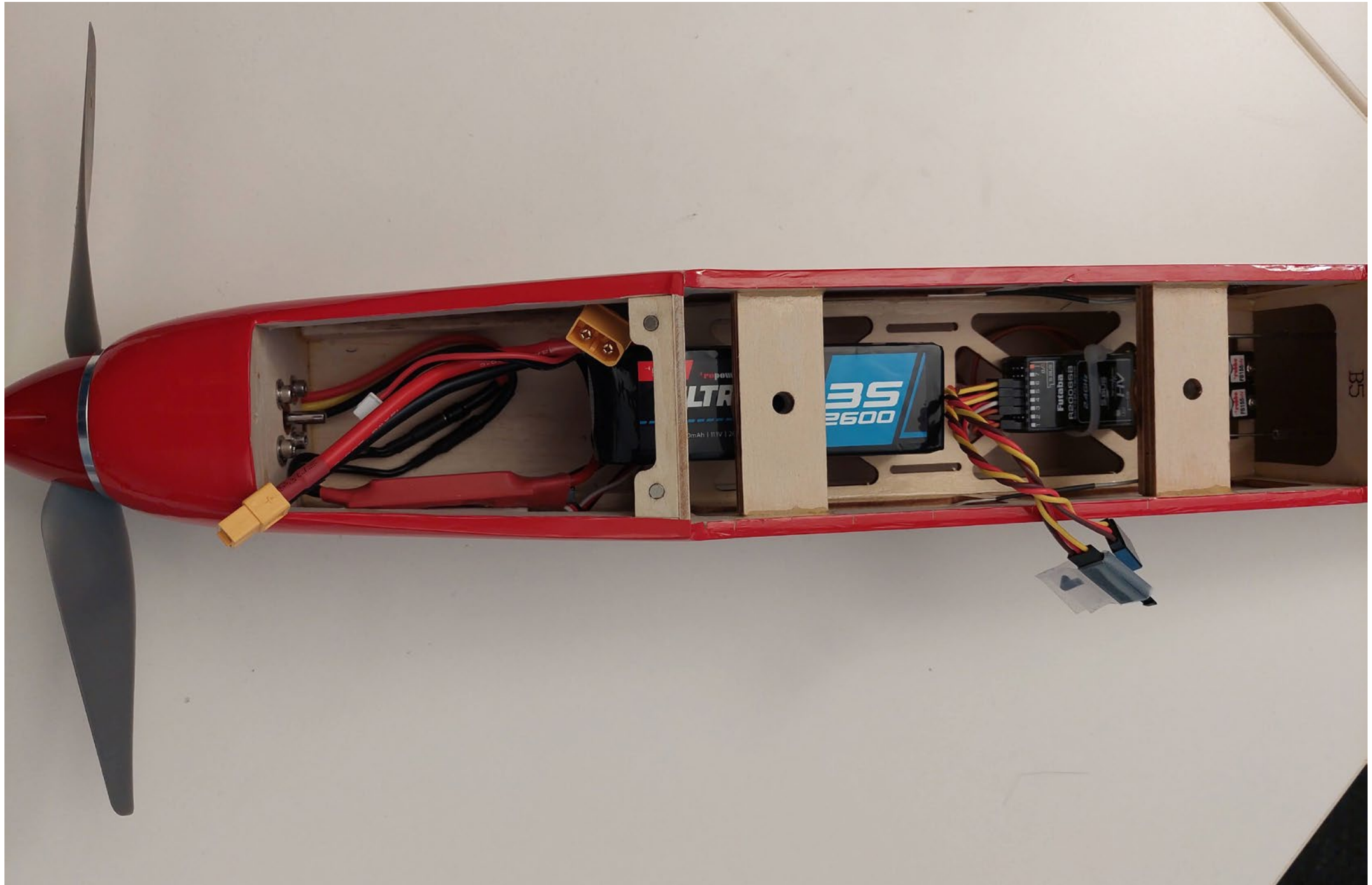



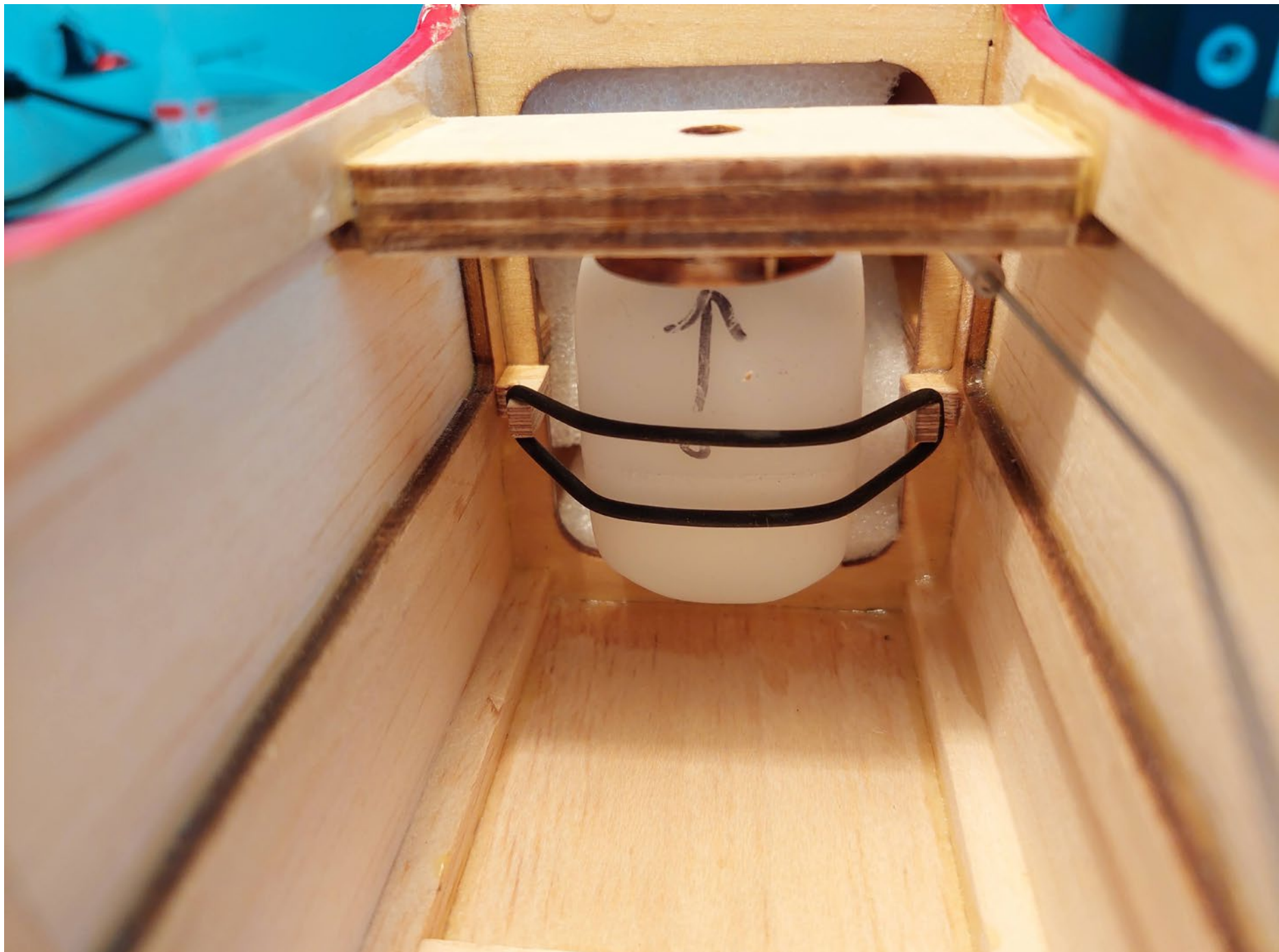





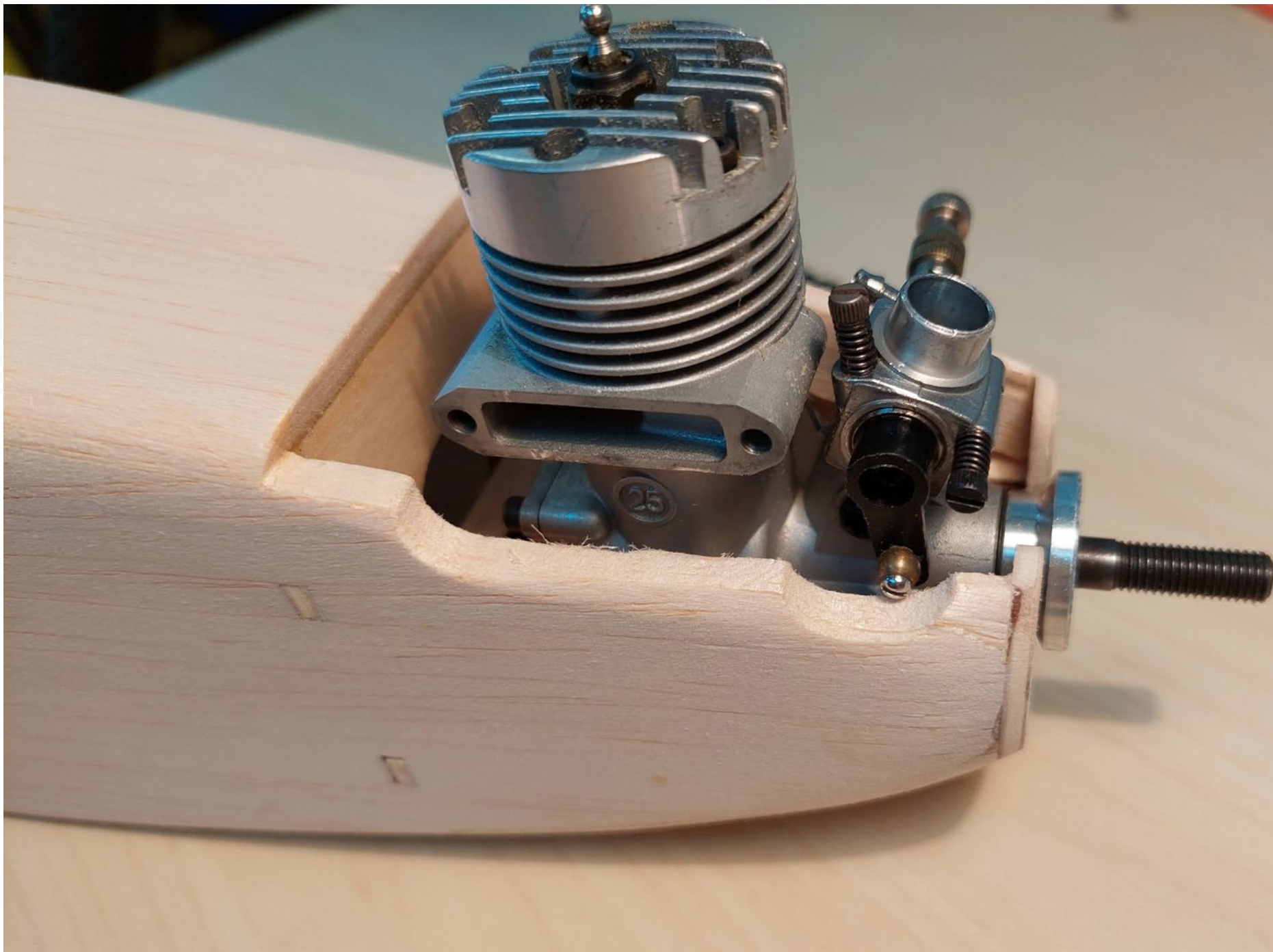

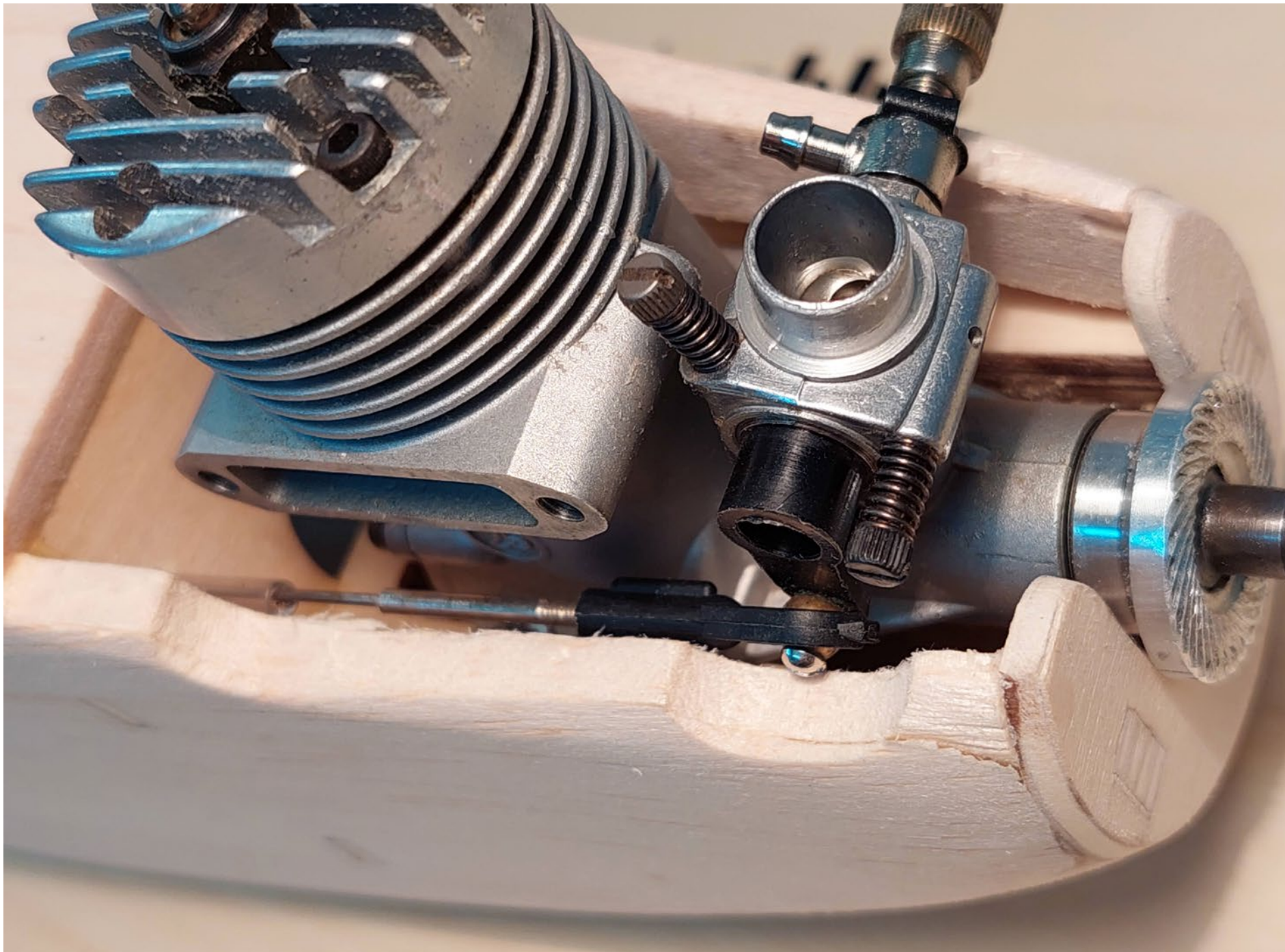

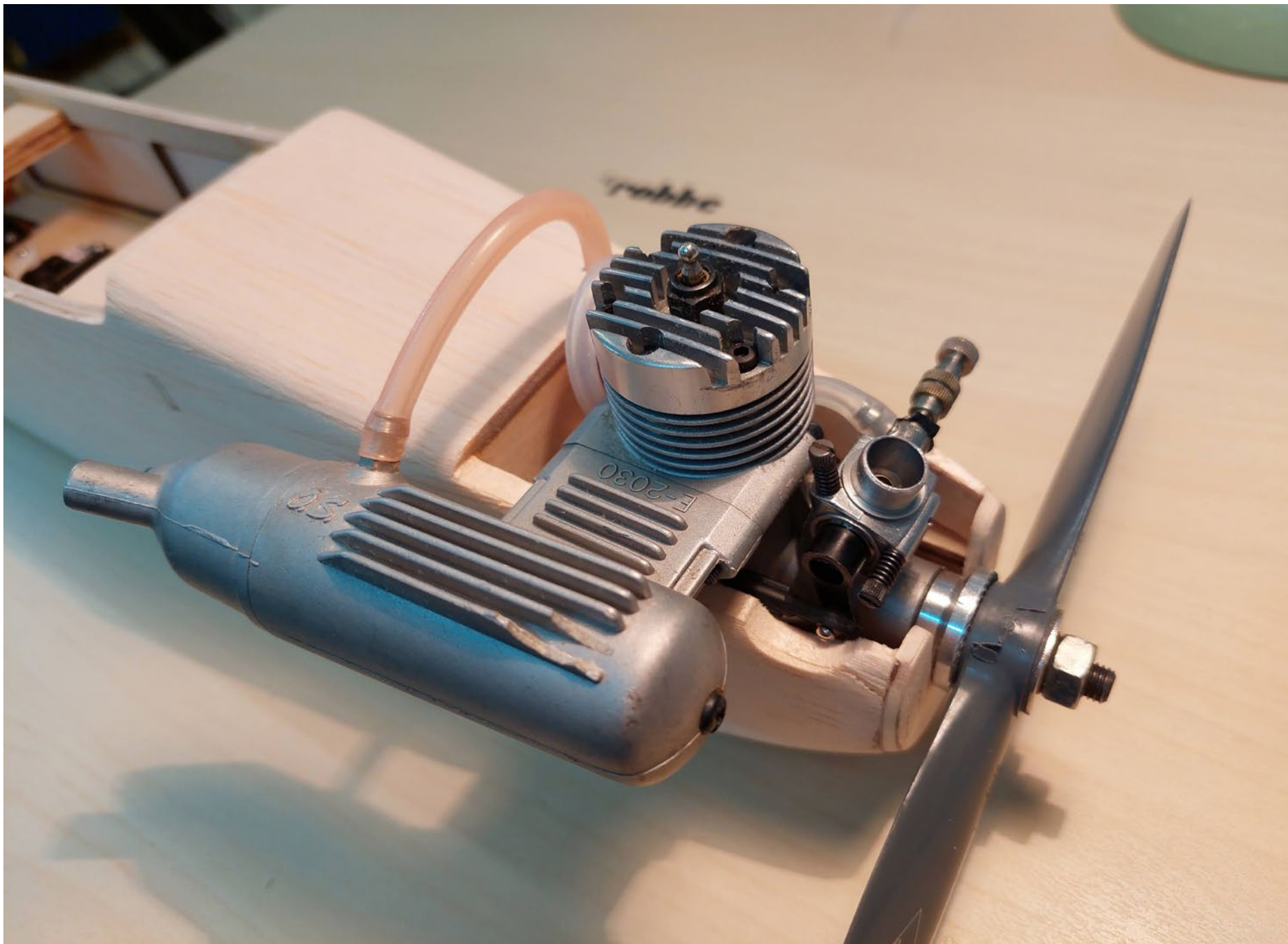









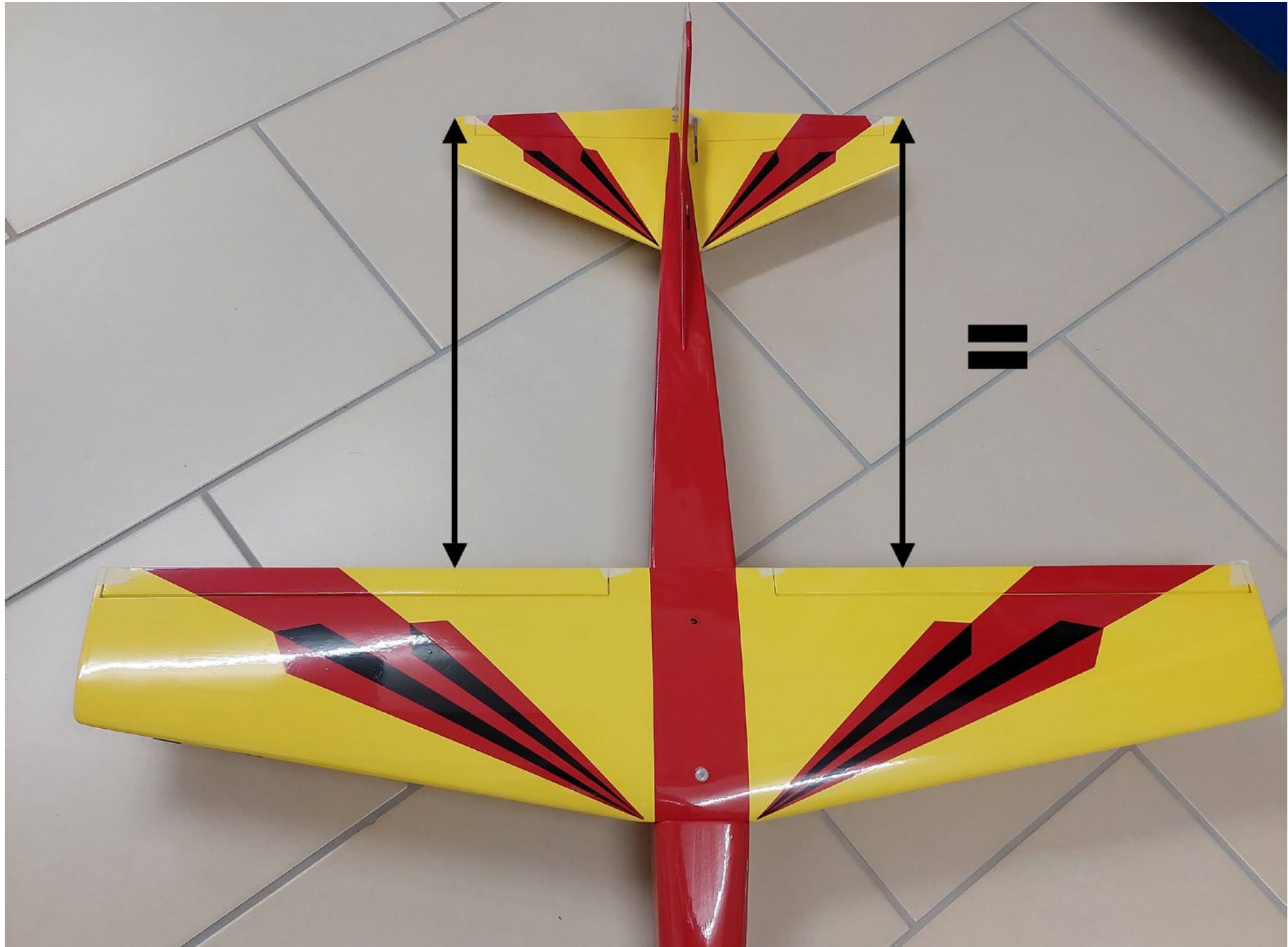
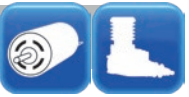



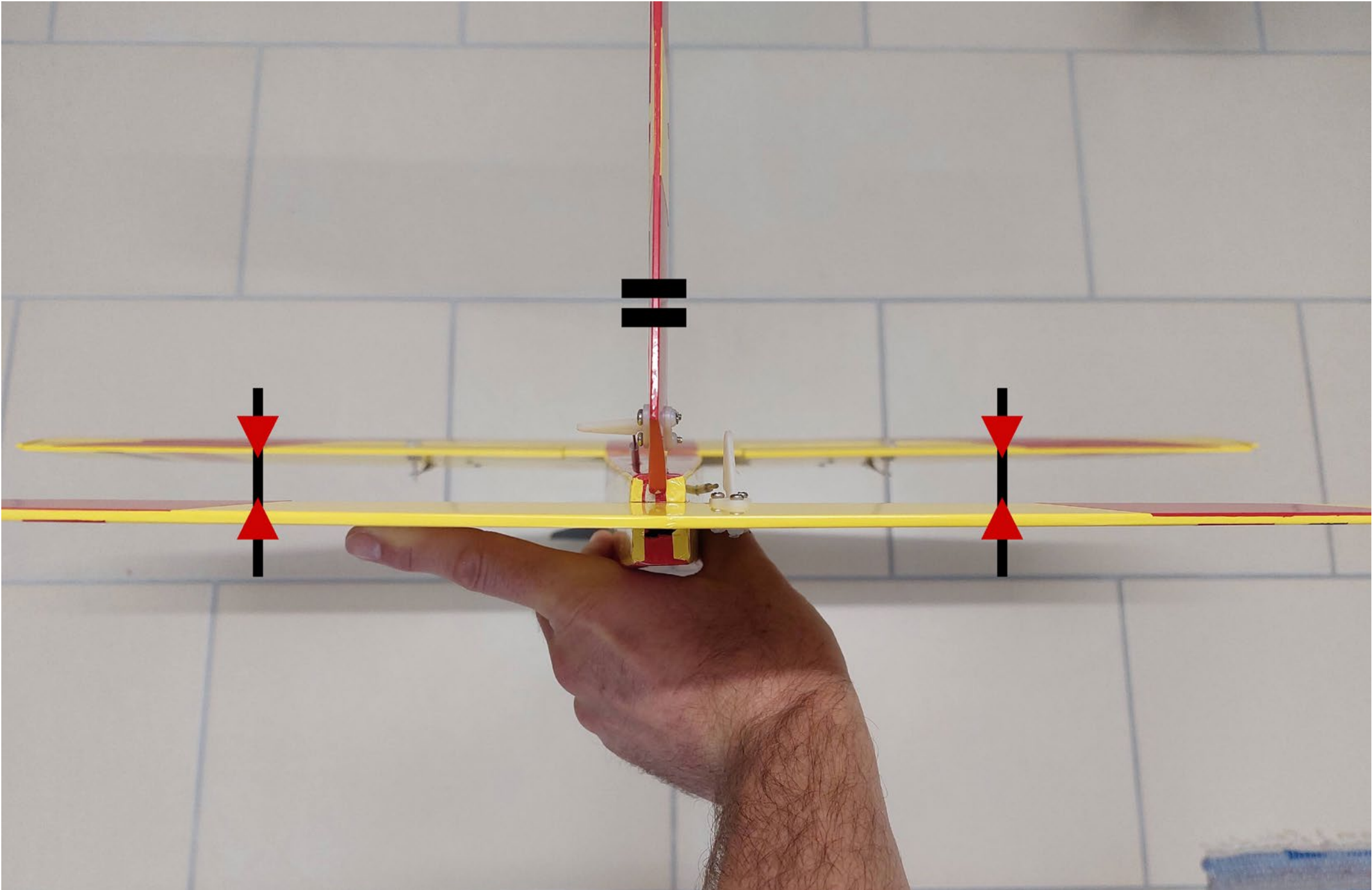
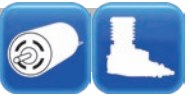





# Rasant

→ **robbe Rasant**

→ **robbe Rasant**

→ **robbe**





## Rudereinstellungen Rudder settings Réglages du gouvernail

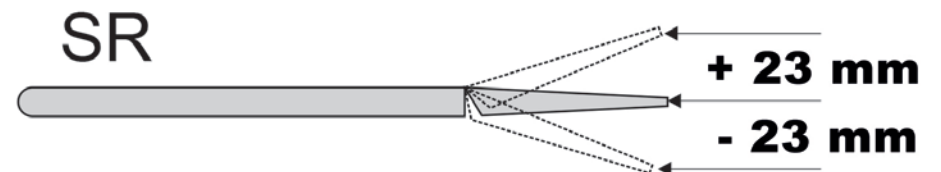
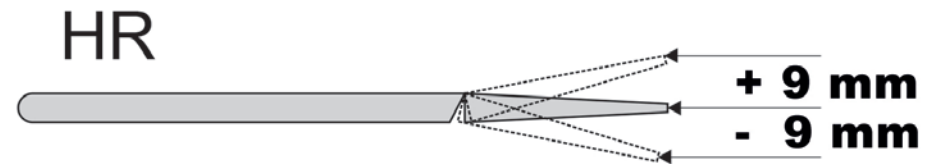
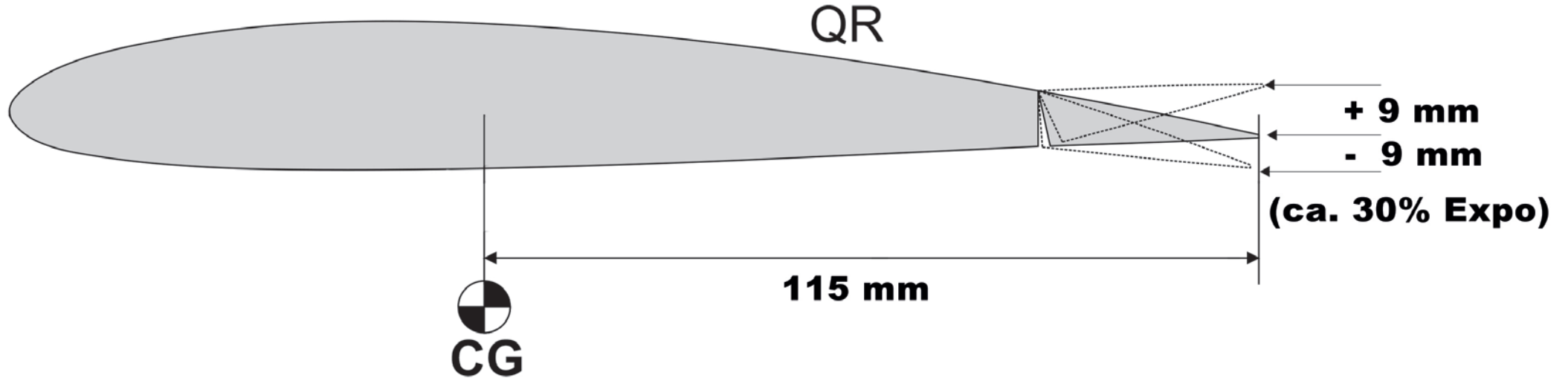



INVERKEHRBRINGER / DISTRIBUTOR / MISE SUR LE MARCHÉ

#### Robbe Modellsport

Industriestraße 10  
4565 Inzersdorf im Kremstal Österreich  
Telefon: +43(0)7582/81313-0  
Mail: info@robbe.com  
UID Nr.: ATU69266037

„robbe Modellsport“ ist eingetragenes  
Markenzeichen.  
Irrtum, Druckfehler und technische Änderun-  
gen vorbehalten.

#### Copyright 2021

Robbe Modellsport 2021  
Kopie und Nachdruck, auch  
auszugsweise, nur mit  
schriftlicher Genehmigung.

#### Service-Adresse

Über Ihren Fachhändler oder:  
Robbe Modellsport, Industriestraße 10,  
4565 Inzersdorf im Kremstal  
service@robbe.com +43(0)7582-81313-0

#### Robbe Modellsport

Industriestraße 10  
4565 Inzersdorf im Kremstal Austria  
Phone: +43(0)7582/81313-0  
Mail: info@robbe.com  
UID No.: ATU69266037

„robbe Modellsport“ is a registered  
Trademark.  
Errors, misprints and technical changes  
reserved.

#### Copyright 2021

Robbe Modellsport 2021  
Copy and reprint only  
with our permission.

#### Service-Address

Contact your Dealer or:  
Robbe Modellsport, Industriestraße 10,  
4565 Inzersdorf im Kremstal  
service@robbe.com, +43(0)7582-81313-0

#### Robbe Modellsport

Industriestraße 10  
4565 Inzersdorf im Kremstal Autriche  
Téléphone: +43(0)7582/81313-0  
Email: info@robbe.com  
UID Nr.: ATU69266037

„robbe Modellsport“ est une marque  
déposée.  
Sous réserve d'erreurs, de fautes d'impression  
et de modifications techniques.

#### Copyright 2021

Robbe Modellsport 2021  
Copie et réimpression, même partielle,  
uniquement avec autorisation écrite.

#### Service

Par l'intermédiaire de votre revendeur  
spécialisé ou :  
Robbe Modellsport, Industriestraße 10,  
4565 Inzersdorf im Kremstal  
service@robbe.com, +43 7582-81313-0



Made in China

+14