



# DECATHLON 60-85cc-3D

Code : SEA 314

## ASSEMBLY MANUAL

“Graphics and specifications may change without notice”.



### Specifications:

Wingspan----- 122.0 in (310.0 cm).  
Wing area----- 2487.8 sq.ins (160.5 sq.dm).  
Weight----- 26.4-27.4 lbs (12.5-13.0kg).  
Length----- 84.6 in (215.0 cm).  
Engine/Motor size----- 60-85cc gasoline.  
Radio----- 7 channels with 9 servos.

## INTRODUCTION

Thank you for choosing the **DECATHLON 60-85cc-3D** ARTF by **SG MODELS**. The **DECATHLON 60-85cc-3D** was designed with the intermediate/advanced sport flyer in mind. It is a semi scale airplane which is easy to fly and quick to assemble. The airframe is conventionally built using balsa, plywood to make it stronger than the average ARTF, yet the design allows the aeroplane to be kept light. You will find that most of the work has been done for you already. The motor mount has been fitted and the hinges are pre-installed. Flying the **DECATHLON 60-85cc-3D** is simply a joy.

This instruction manual is designed to help you build a great flying aeroplane. Please read this manual throughly before starting assembly of your **DECATHLON 60-85cc-3D**. Use the parts listing below to indentify all parts.

## WARNING

***Please be aware that this aeroplane is not a toy and if assembled or used incorrectly it is capable of causing injury to people or property. WHEN YOU FLY THIS AEROPLANE YOU ASSUME ALL RISK & REponsibility.***

If you are inexperienced with basic R/C flight we strongly recommend you contact your R/C supplier and join your local R/C model Flying Club. R/C Model Flying Clubs offer a variety of training procedures designed to help the new pilot on his way to successful R/C flight. They will also be able to advise on any insurance and safety regulations that may apply.

## KIT CONTENTS

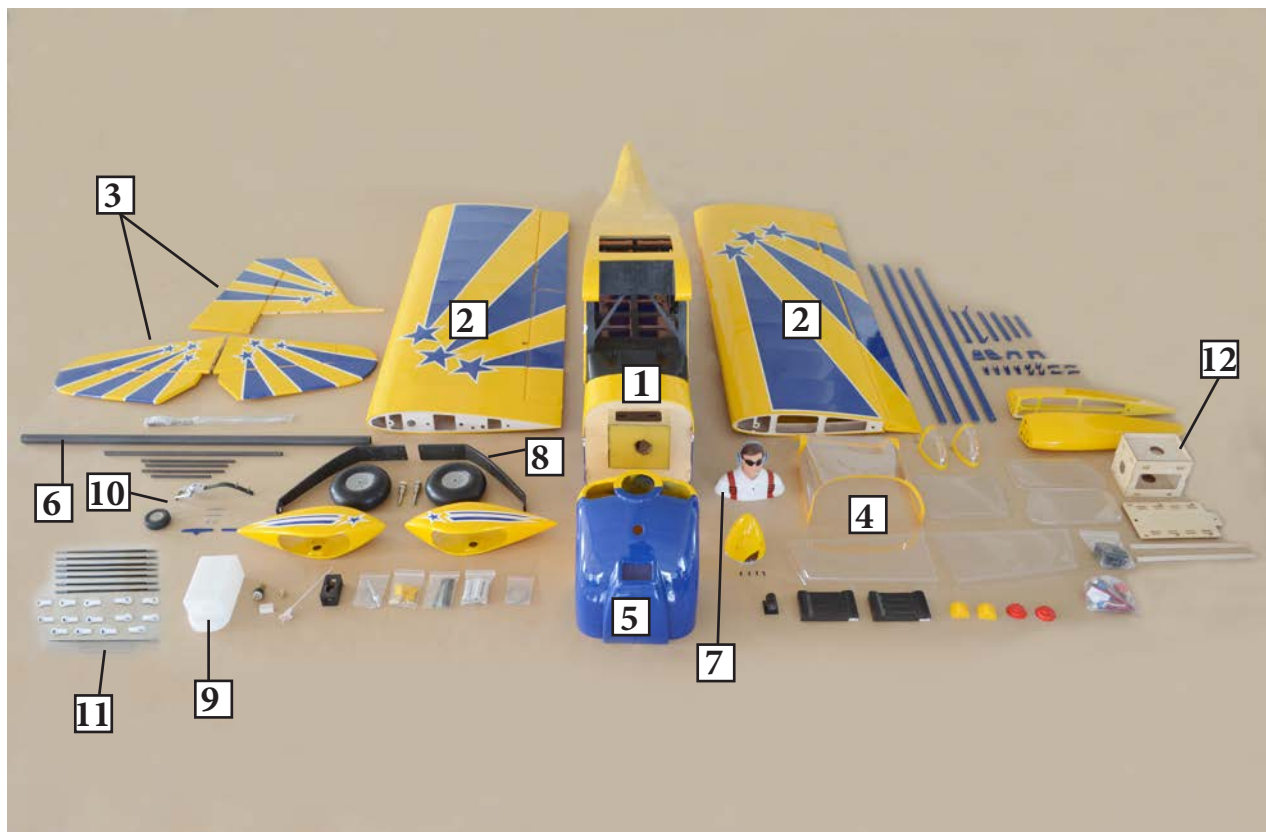

## KIT CONTENTS

### SEA314 DECATHLON 60-85cc-3D

1. Fuselage
2. Wing set (2)
3. Tail set (2)
4. Canopy
5. Cowling
6. Wing tube
7. Pilot
8. landing gear
9. Fuel tank
10. Tail wheel
11. Pushrod set
12. Ep Motor box

## ADDITIONAL ITEMS REQUIRED

- 60-85cc gasoline engine.
- Computer radio 7 channel with 9 servos.
- Glow plug to suit engine.
- Propeller to suit engine.
- Protective foam rubber for radio system.

## TOOLS & SUPPLIES NEEDED

- Thin cyanoacrylate glue.
- Medium cyanoacrylate glue.
- 30 minute epoxy.
- 5 minute epoxy.
- Hand or electric drill.
- Assorted drill bits.
- Modelling knife.
- Straight edge ruler.
- 2mm ball driver.
- Phillips head screwdriver.
- 220 grit sandpaper.
- 90° square or builder's triangle.
- Wire cutters.
- Masking tape & T-pins.
- Thread-lock.
- Paper towels.

## WINGTIP BULBS

Please see below pictures.

1.

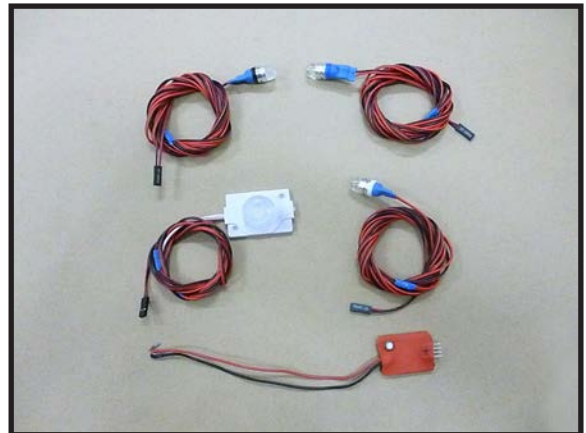

Two white lights for cowling and rudder, the green light for right wing tip, and the red light for left wing tip. They are designed to operate on voltages 12 volts. Connect four lights into switch circuit so that optional the different flashes mode.

2.



3.



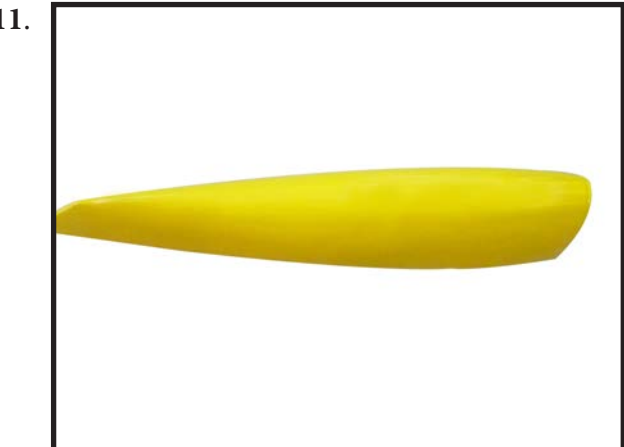
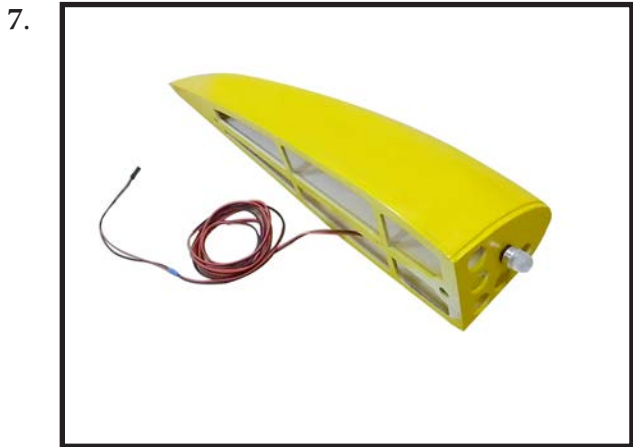
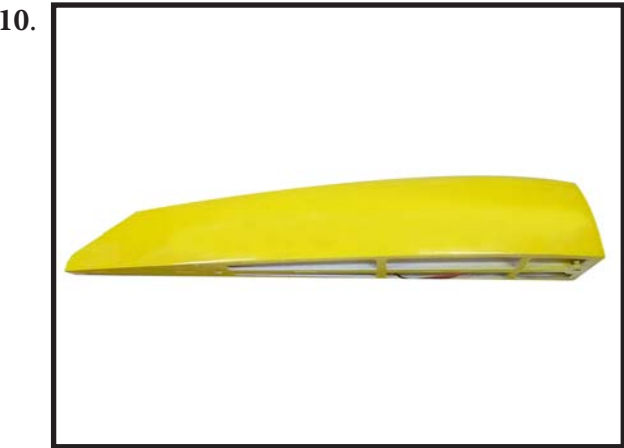
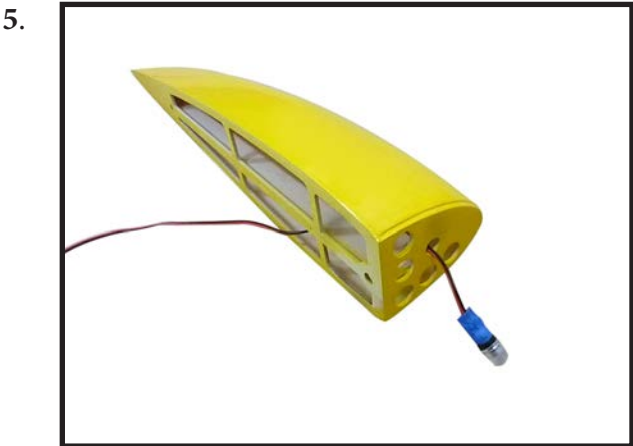
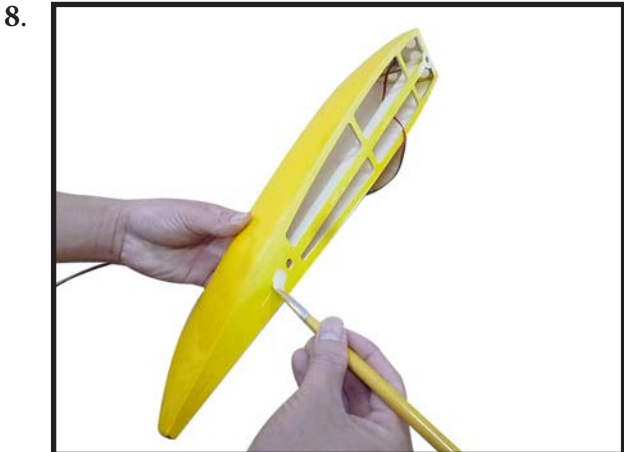
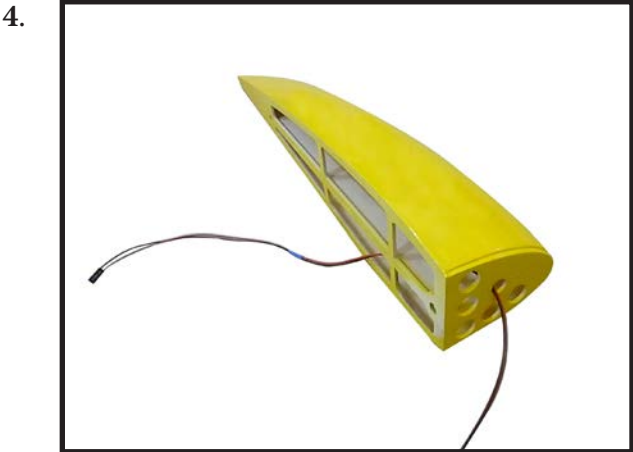

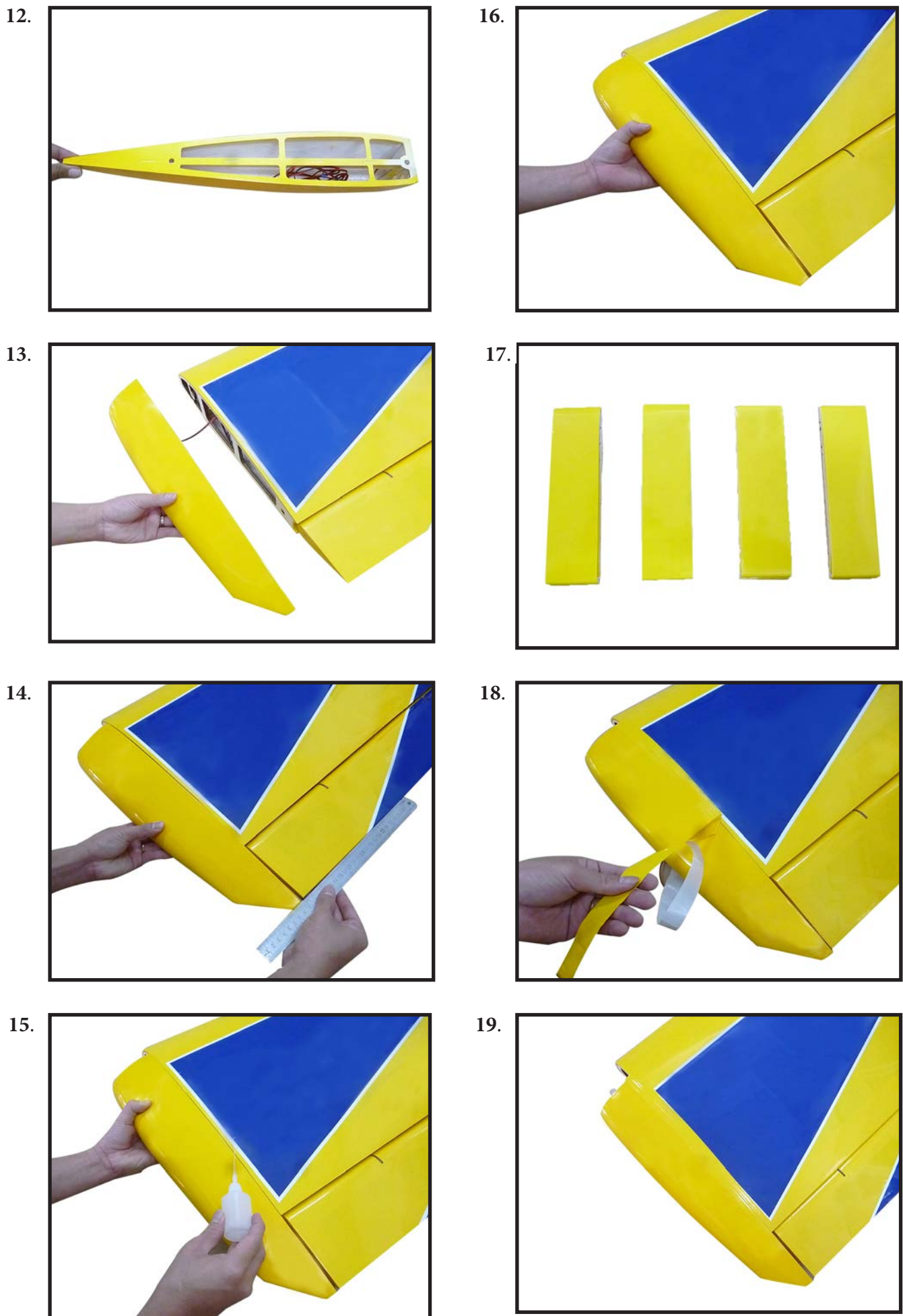



**INSTALL THE AILERONS CONTROL HORN**

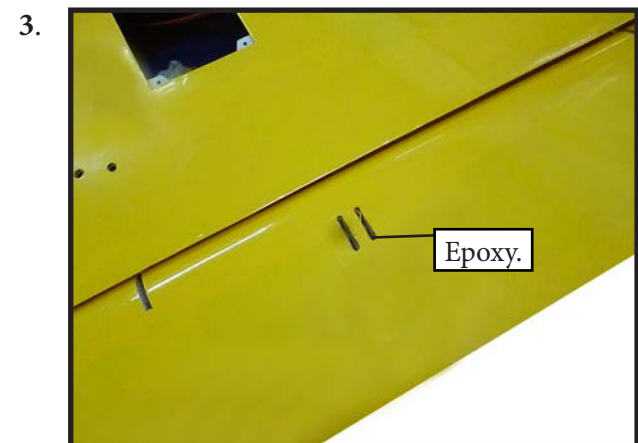
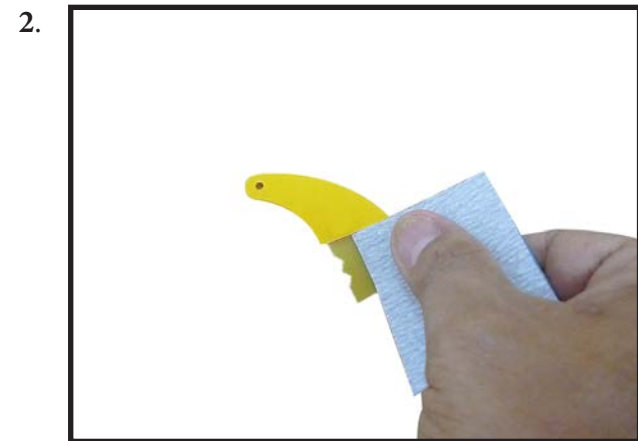
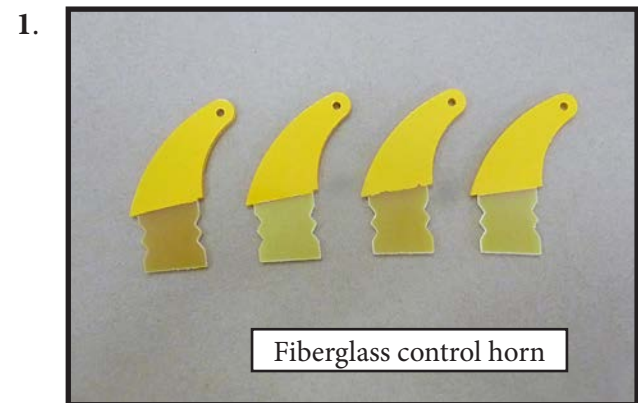

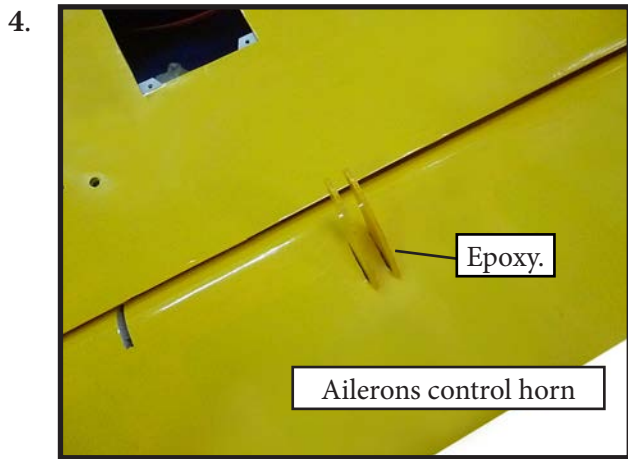

**INSTALLING THE AILERON SERVOS**

Place the servo between the mounting blocks and space it from the hatch. Use a pencil to mark the mounting hole locations on the blocks.

Use drill bit in a pin vise to drill the mounting holes in the blocks.

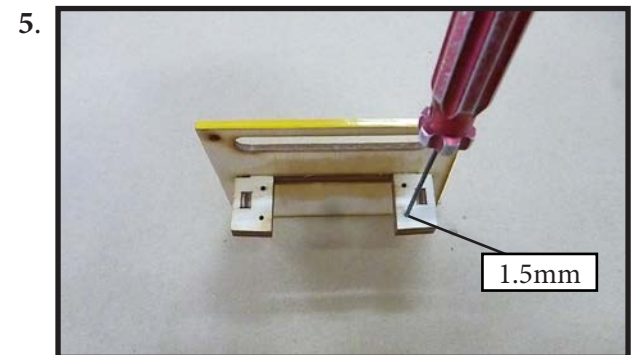
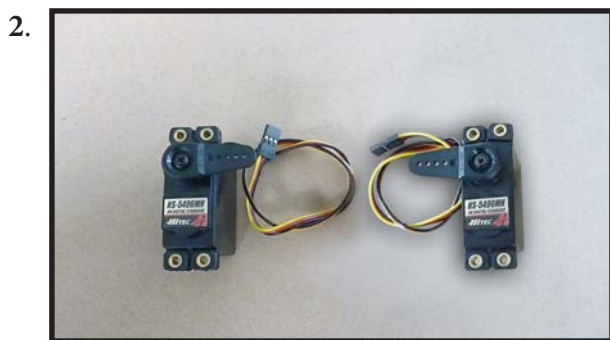
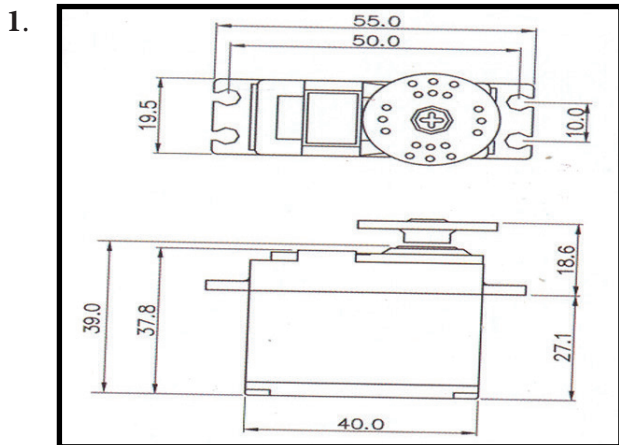
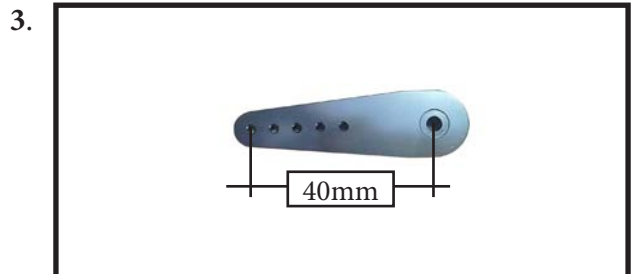

**Minimum servo spec.**  
**Torque :** 250 oz-in (18 kg-cm) @ 4.8V;  
 333 oz-in (24 kg-cm) @ 6.0V

Apply 2-3 drops of thin C/A to each of the mounting holes. Allow the C/A to cure without using accelerator.

Because the size of servos differ, you may need to adjust the size of the precut opening in the mount. The notch in the sides of the mount allow the servo lead to pass through.

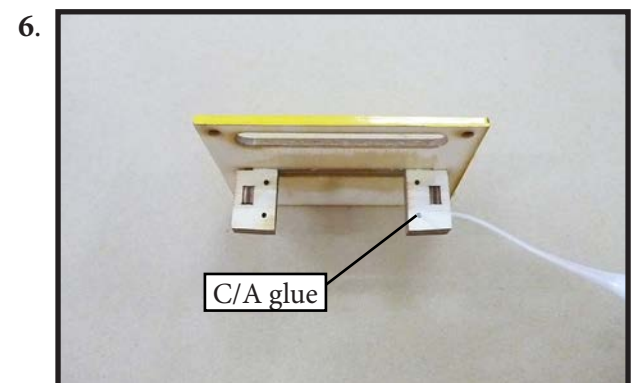

Use dental floss or heatshrink tube to secure the connection so they cannot become unplugged.

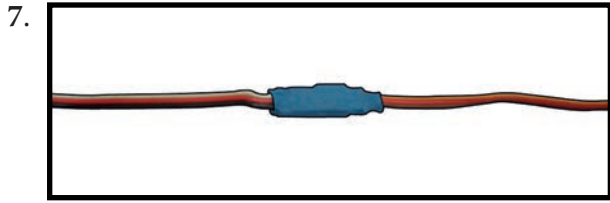

Secure the servo to the aileron hatch using Phillips screwdriver and the screws provided with the servo.

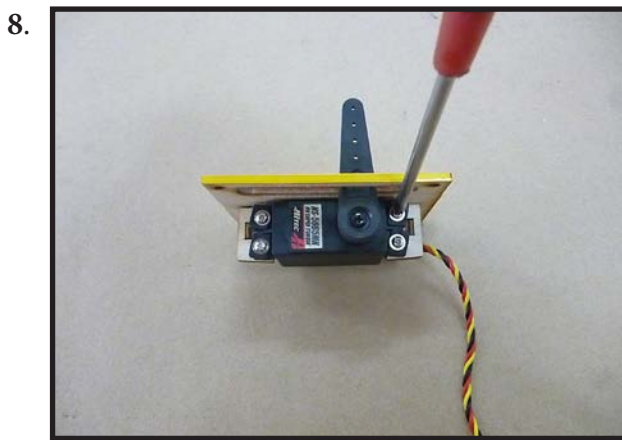

Apply 1-2 drops of thin C/A to each of the mounting tabs. Allow the C/A to cure without using accelerator.

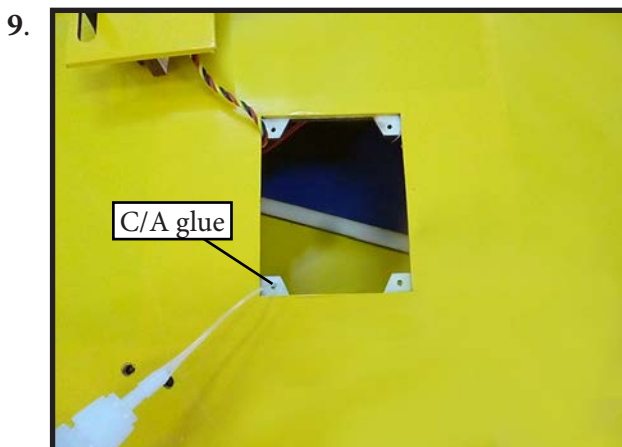

Remove the string from the wing at the servo location and use the tape to attach it to the servo extension lead. Pull the lead through the wing and remove the string.

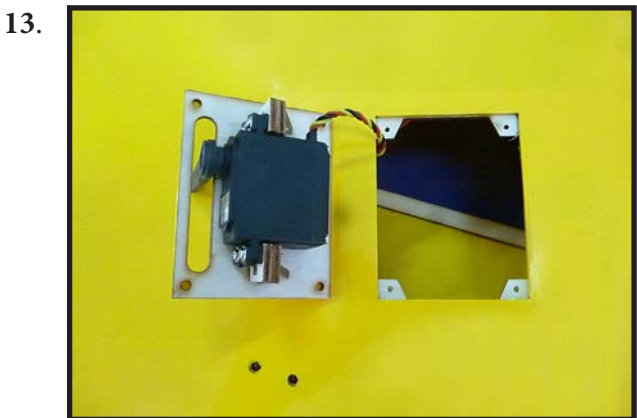
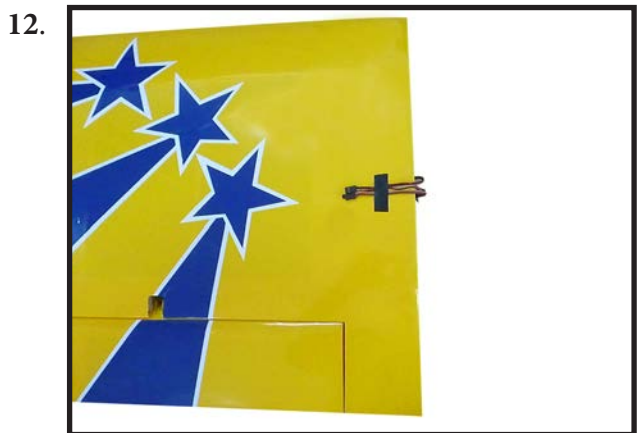
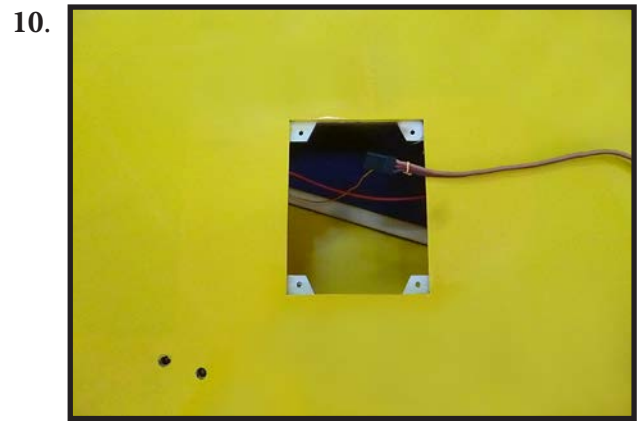

Set the aileron hatch in place and use a Phillips screw driver to install it with four wood screws.



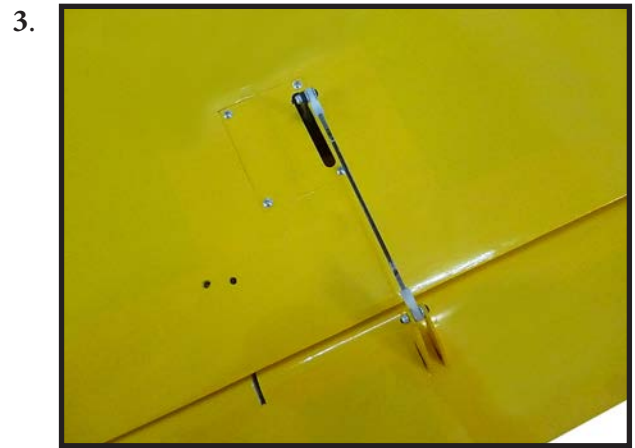
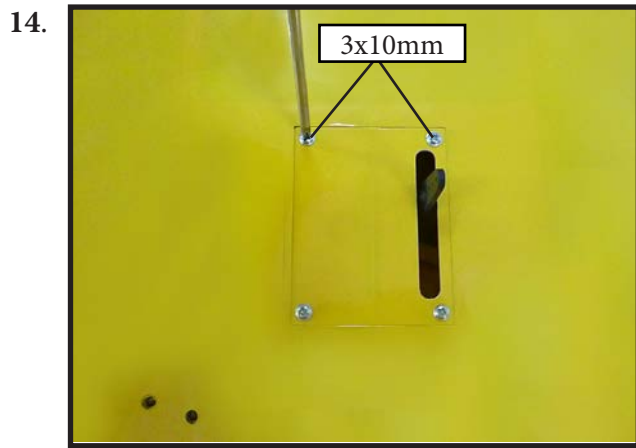

**INSTALLING THE FLAP PUSHROD**

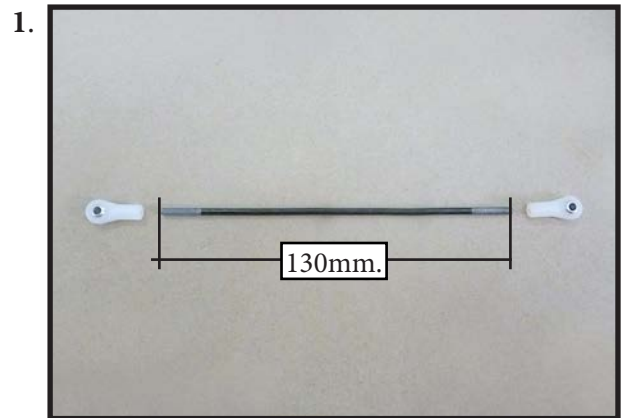

**AILERON PUSHROD INSTALLATION**

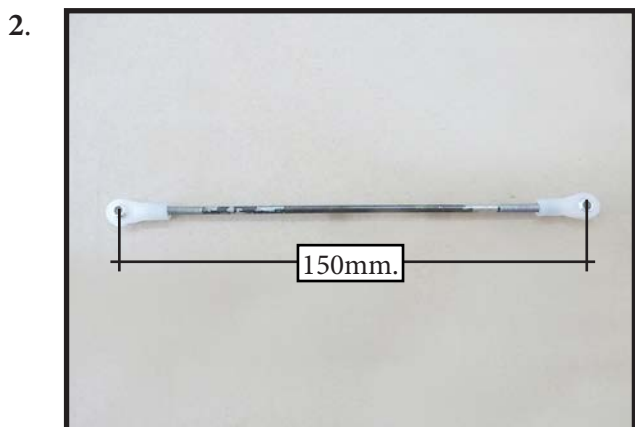
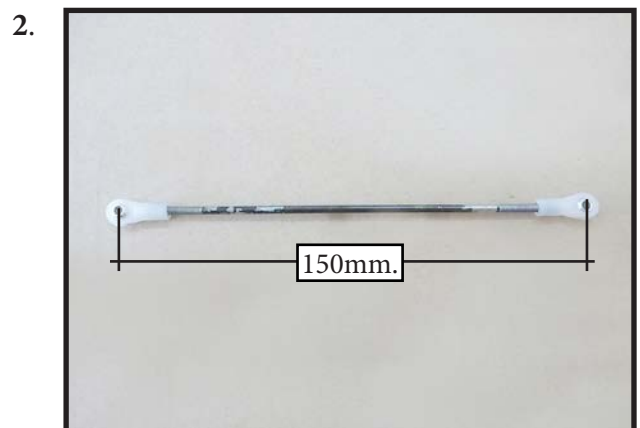
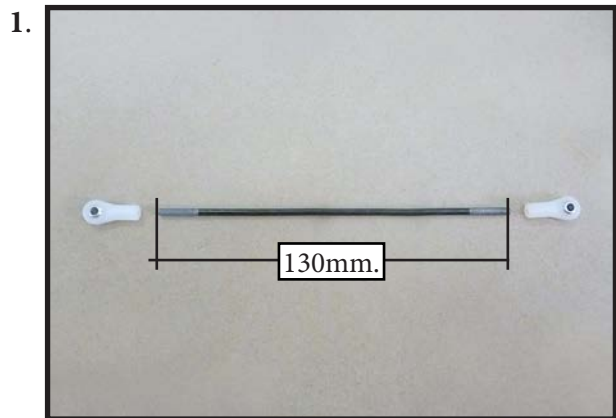

Attach the flap servo to the flap servo cover. Center the flap servo (or set the values to 0 for both up and down) and install the servo arm perpendicular to the servo centerline. The clevis will attach to the arm 13/16 inches (21mm) from the center of the arm.

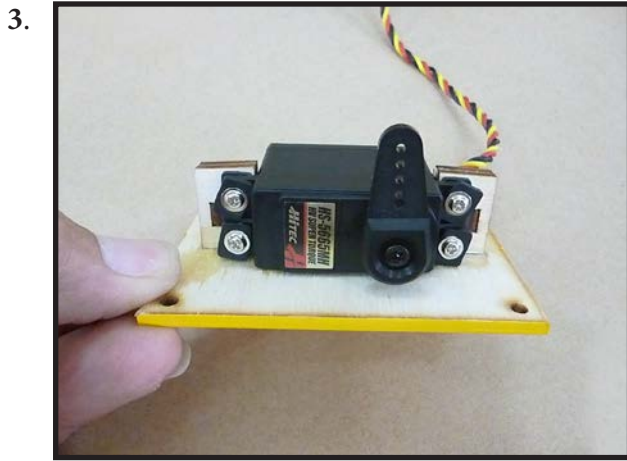

Use a pin vise and 3/32-inch (2mm) drill bit to clear the paint from the flap control horn.



Attach the flap linkage to the control horn. Slide the clevis retainer over the forks of the clevis.

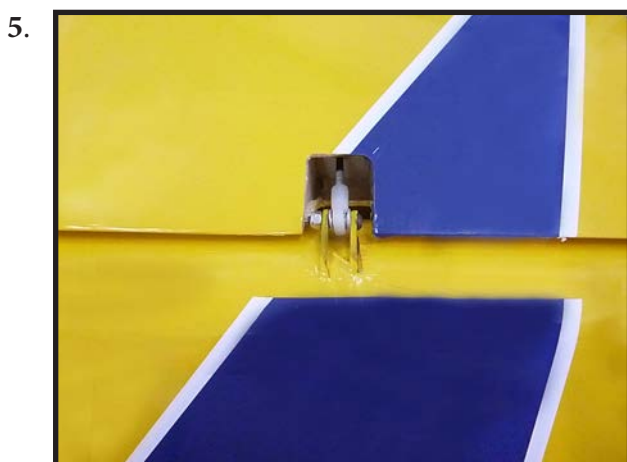

Attach the clevis to the flap servo arm.

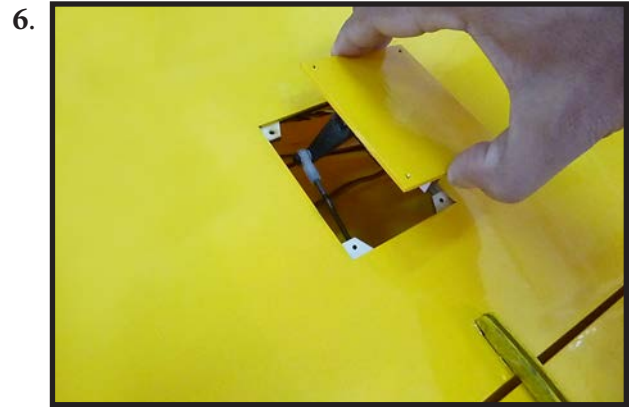

Route the servo lead for the flap servo out at the root of the wing. Connect the flap servo to the radio system. With the radio system on, place the flap servo into position.

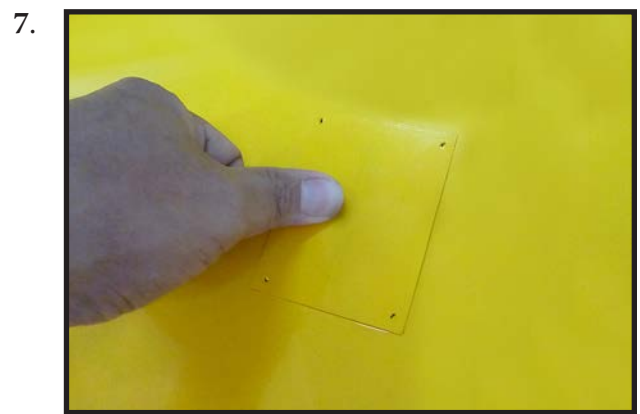

Adjust the linkage so the flap is in the mid-flap position. It may take a few tries to properly adjust the linkage.



Once adjusted, make sure all clevis retainers are in position. Apply a drop of threadlock near the clevis, then tighten the nut against the clevis to keep the linkage from changing length inside the wing.

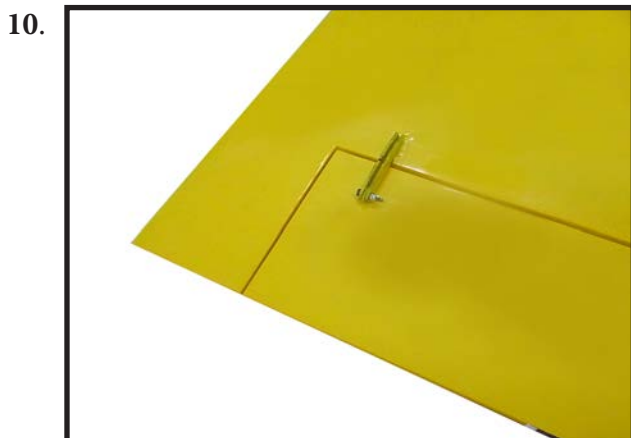
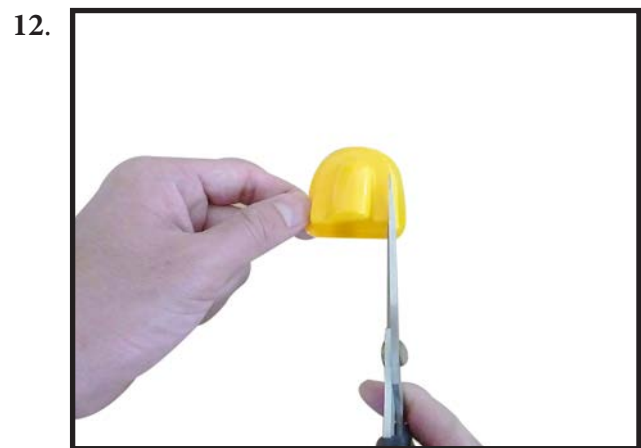
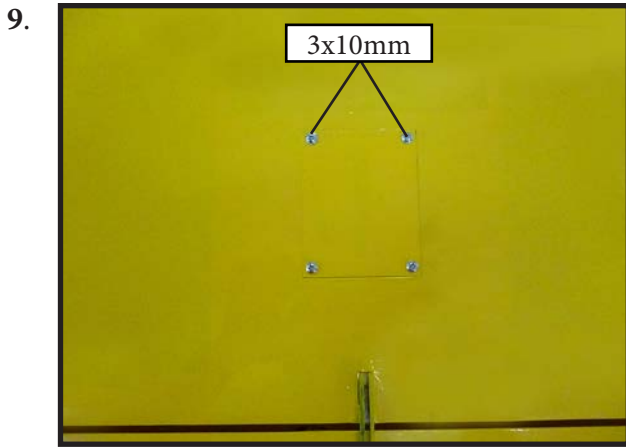

Set the flap control at the transmitter to the down flap position. Adjust the flap travel at the transmitter until it matches the control throws listed in this manual.

Fit the flap linkage cover into position. Check the operation of the flap to make sure the cover does not interfere with the flap linkage.

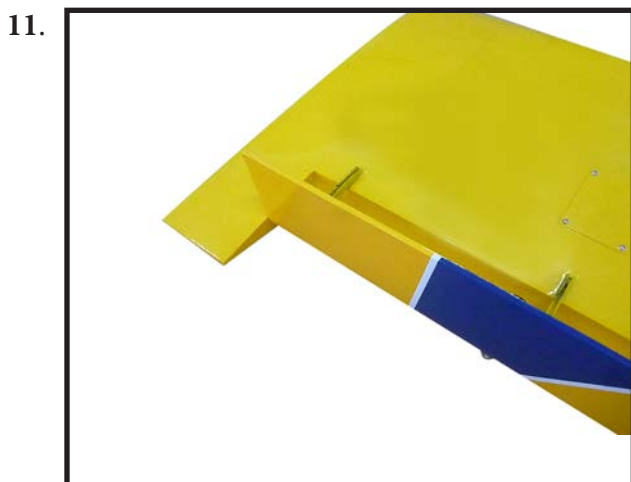

Trim the flap linkage cover using a hobby knife and hobby scissors.

Use canopy glue to attach the cover to the wing. Use low-tack tape to keep the cover in position until the adhesive fully cures.

15.



**INSTALLING LANDING GEAR**

Locate items necessary to install Sprin Landing Gear.

1.



2.



3.



4.

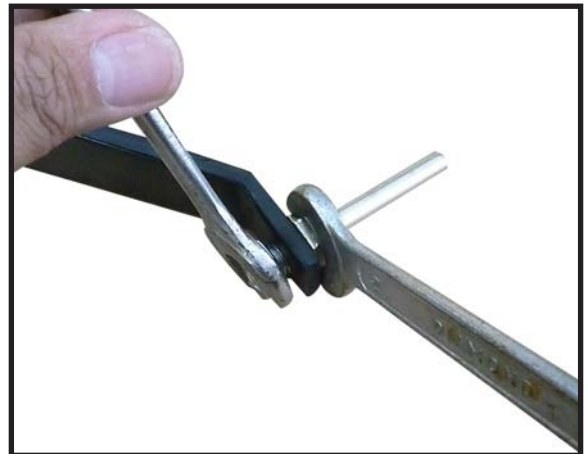

5.



6.

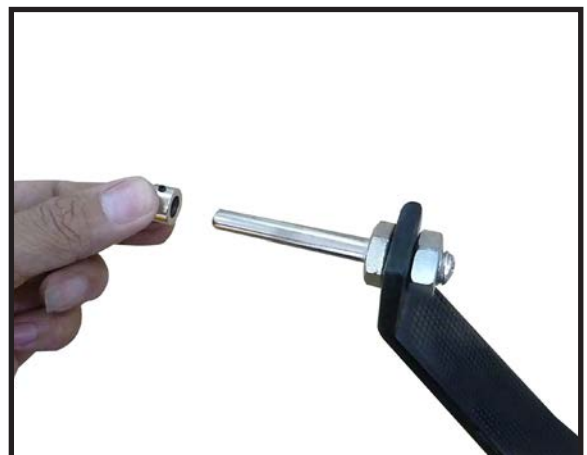

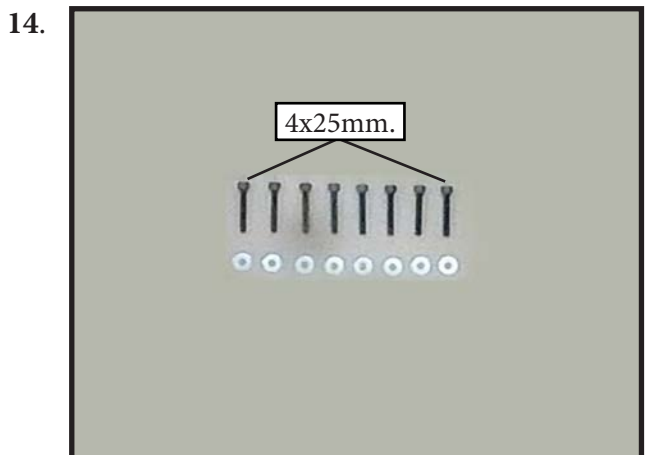
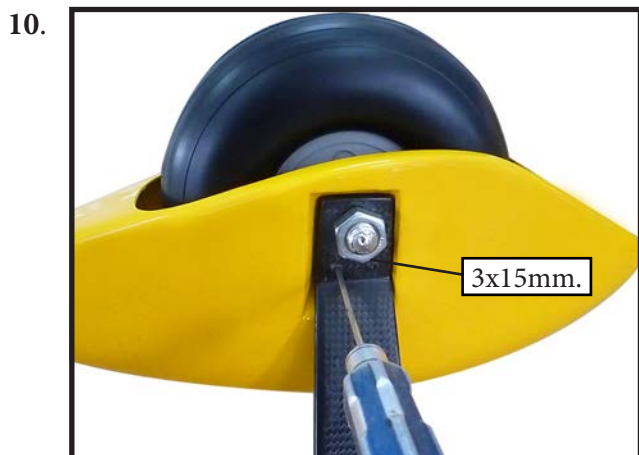
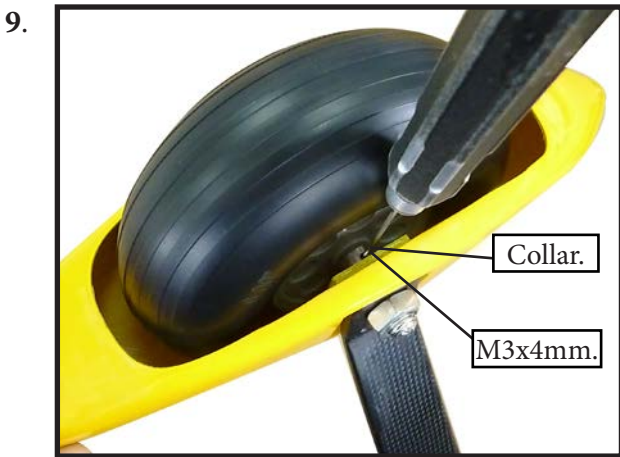

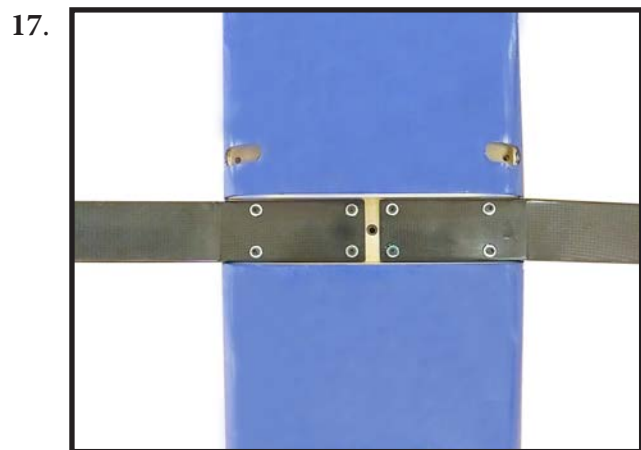
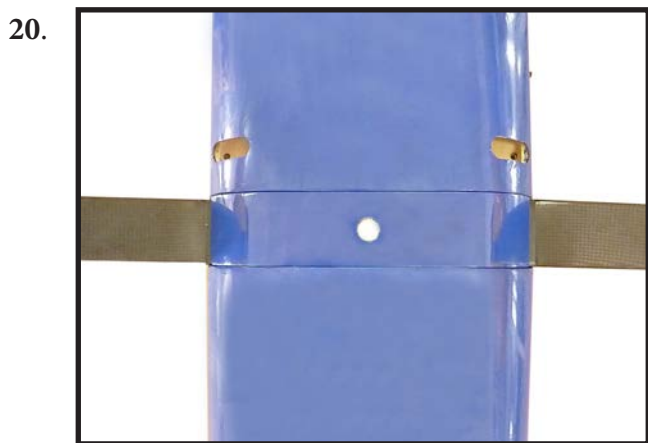
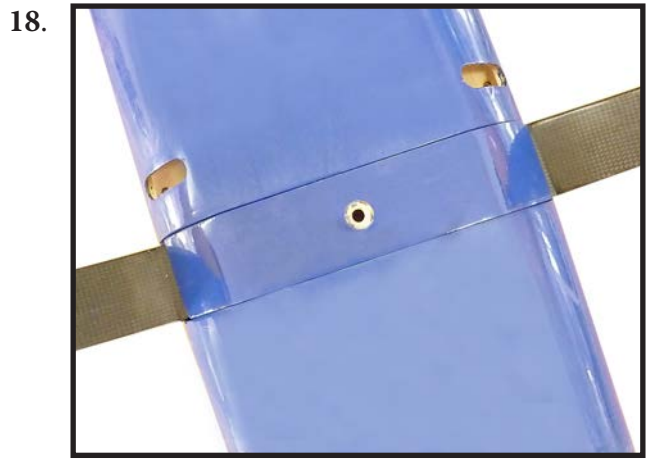
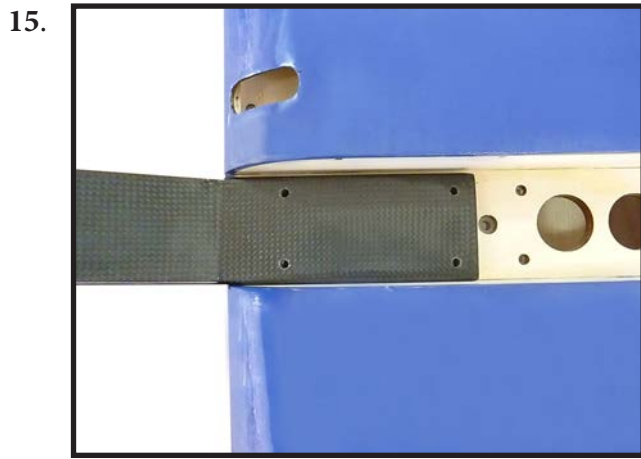

**INSTALLING THE FUSELAGE SERVOS**

 Because the size of servos differ, you may need to adjust the size of the precut opening in the mount. The notch in the sides of the mount allow the servo lead to pass through.

Install the rubber grommets and brass collets into all servos. Test fit the servos into the fuselage servo mounts.

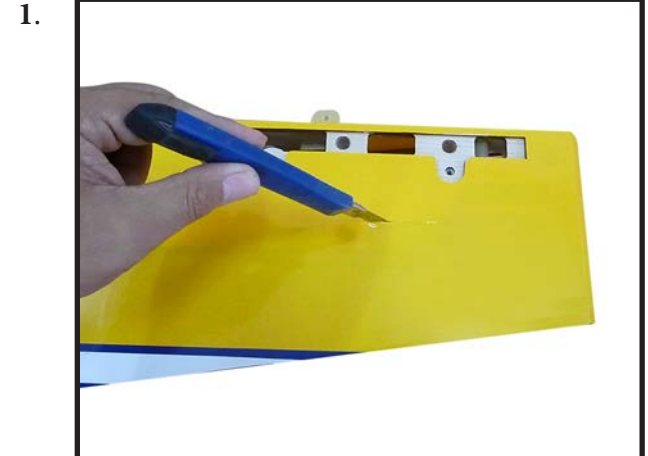

2.



6.

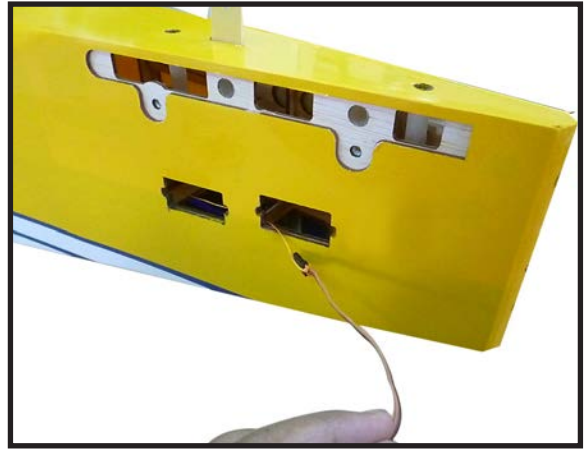

3.

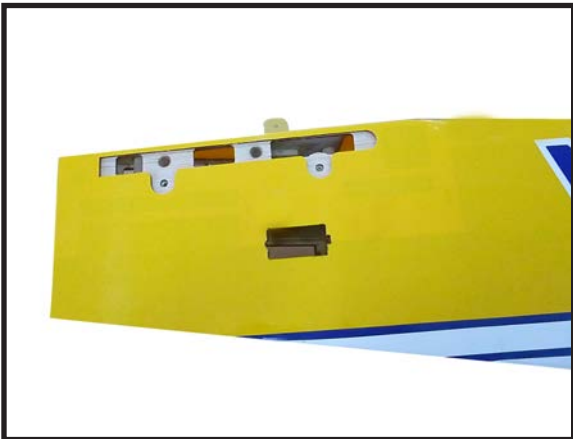

7.

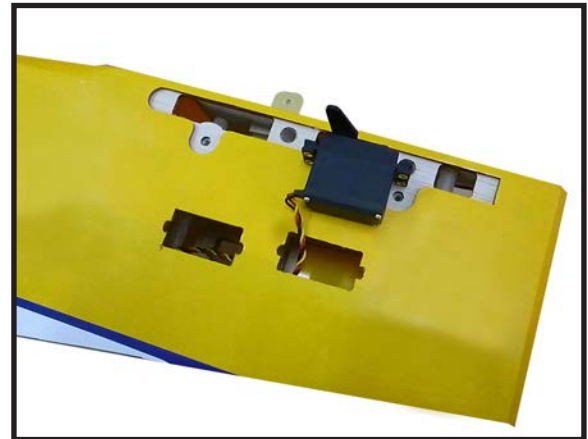

4.



8.



5.



9.

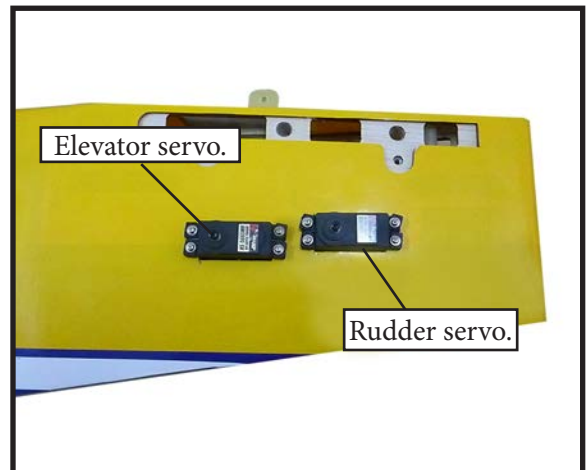

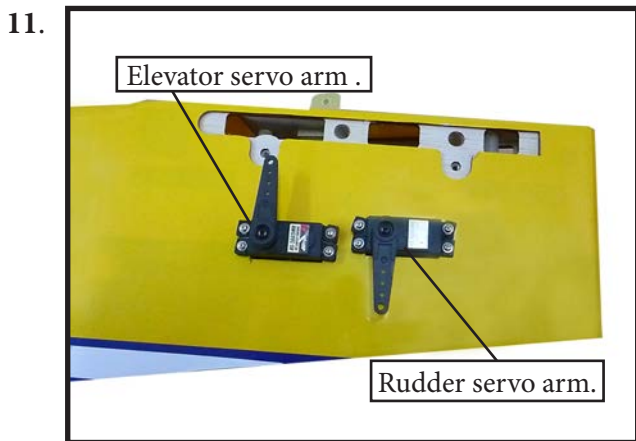
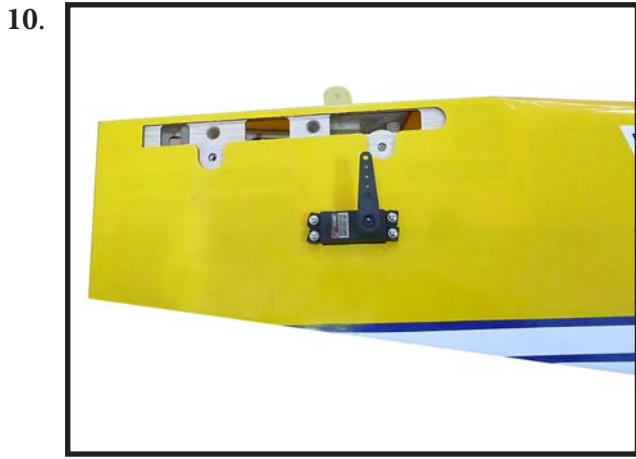

**INSTALLING THE RECEIVER SWITCH**

Install the switch into the precut hole in the side, in the fuselage.

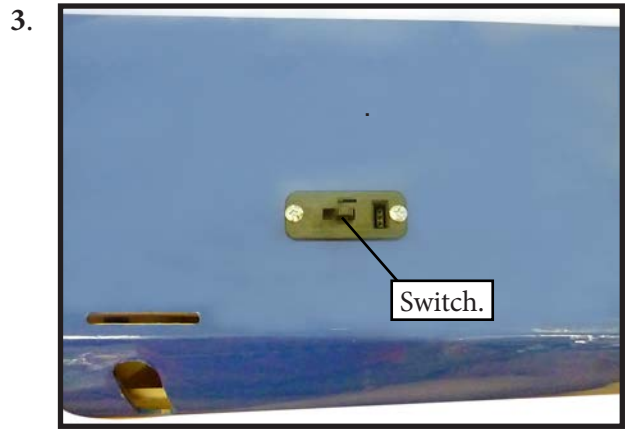
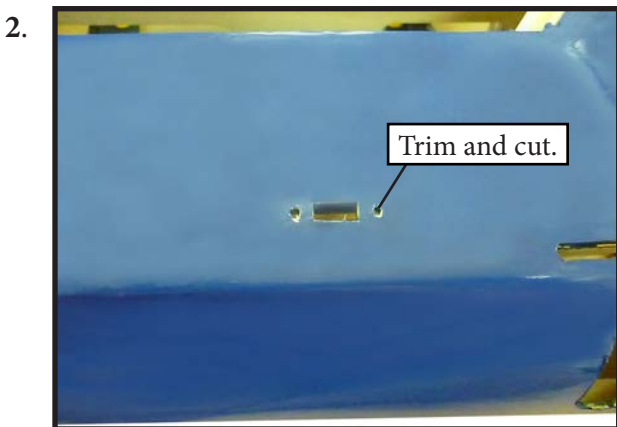
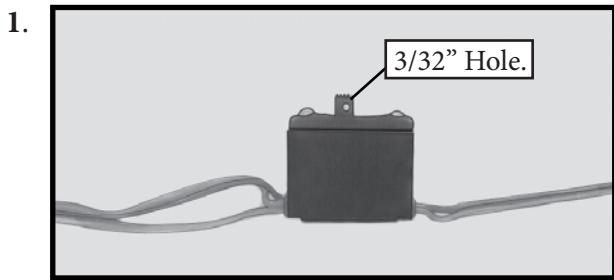

**INSTALLING THE ENGINE SWITCH**

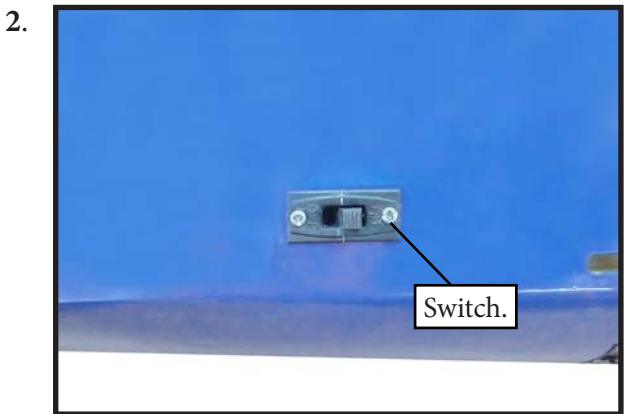
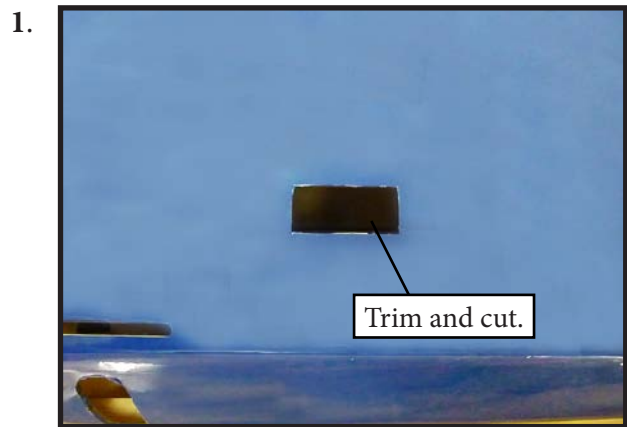

**INSTALLING THE STOPPER ASSEMBLY**

Using a modeling knife, carefully cut off the rear portion of one of the 3 nylon tubes leaving 1/2" protruding from the rear of the stopper. This will be the fuel pick up tube.



Using a modeling knife, cut one length of silicon fuel line. Connect one end of the line to the weighted fuel pick up and the other end to the nylon pick up tube.

1.

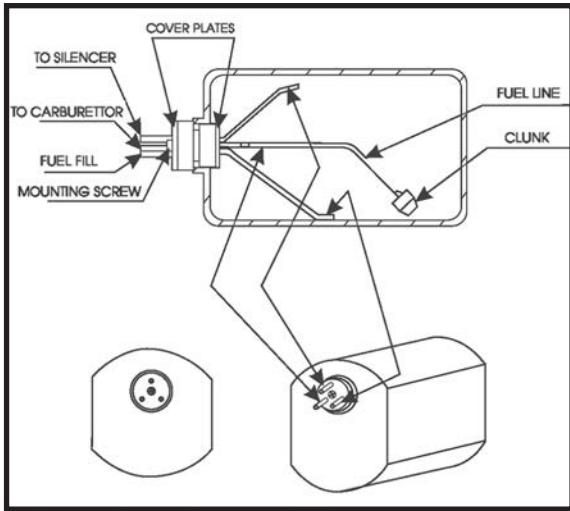

2.

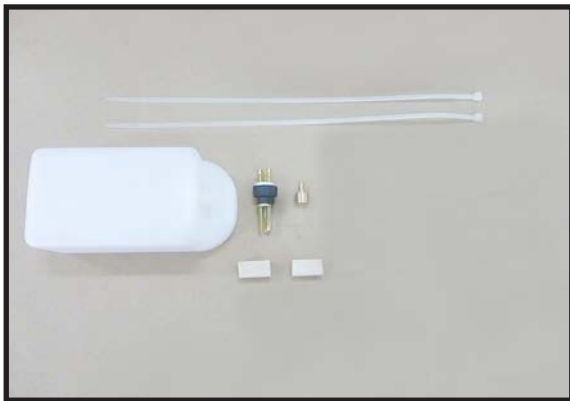

3.

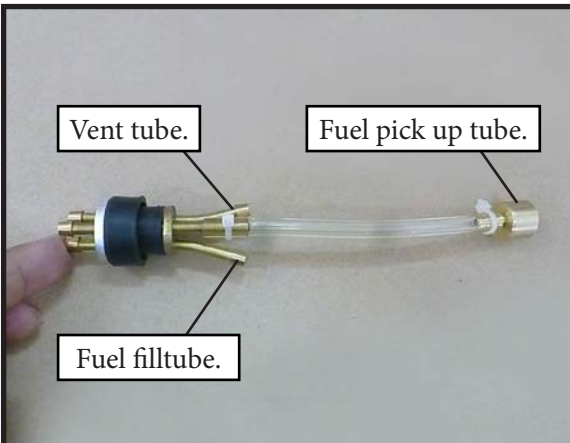

Carefully bend the second nylon tube up at a 45° angle. This tube is the vent tube.

Test fit the stopper assembly into the tank. It may be necessary to remove some of the flashing around the tank opening using a modeling knife. If flashing is present, make sure none falls into the tank.

With the stopper assembly in place, the weighted pick-up should rest away from the rear of the tank and move freely inside the tank. The top of the vent tube should rest just below the top of the tank. It should not touch the top of the tank.

When satisfied with the alignment of the stopper assembly tighten the 3x20mm machine screw until the rubber stopper expands and seals the tank opening. Do not overtighten the assembly as this could cause the tank to split.

## FUEL TANK INSTALLATION

1.



**⚠** You should mark which tube is the vent and which is the fuel pickup when you attach fuel tubing to the tubes in the stopper. Once the tank is installed inside the fuselage, it may be difficult to determine which is which.

Slide the fuel tank into the fuselage. Guide the lines from the tank through the hole in the firewall.

2.



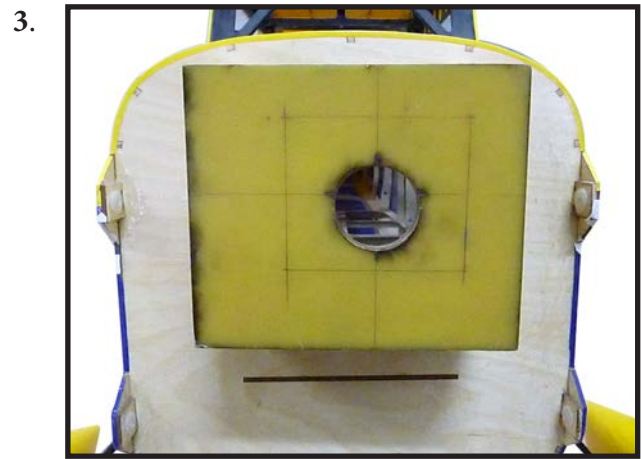
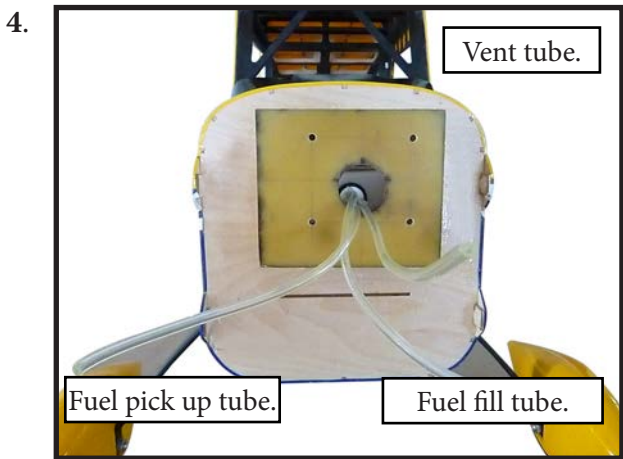
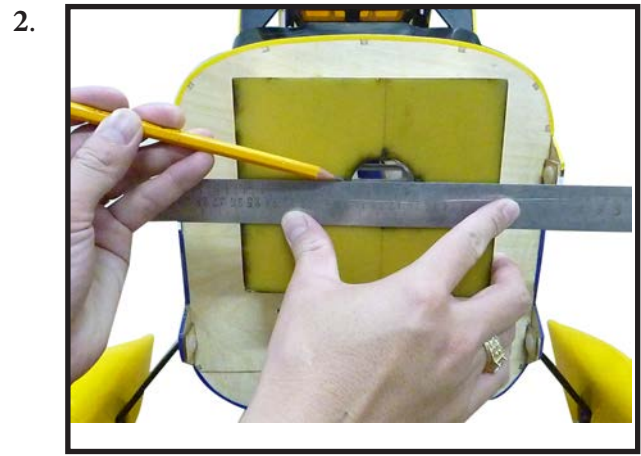
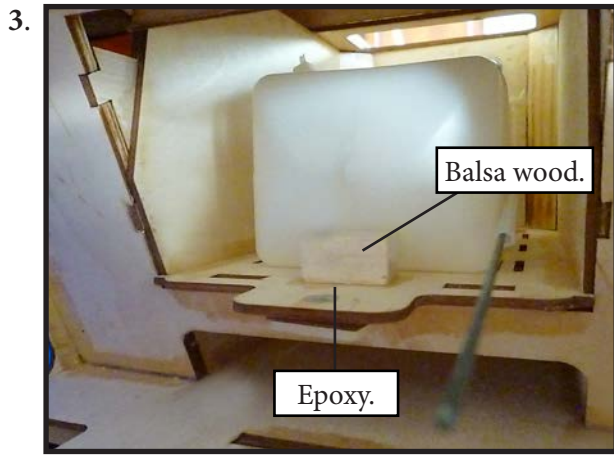

Connect the lines from the tank to the engine and muffler. The vent line will connect to the muffler and the line from the clunk to the carburetor.

**!** *Blow through one of the lines to ensure the fuel lines have not become kinked inside the fuel tank compartment. Air should flow through easily.*

**MOUNTING THE ENGINE**

Please see below pictures.

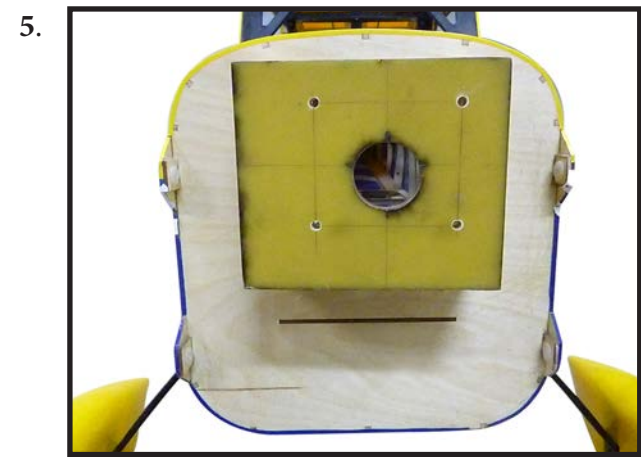
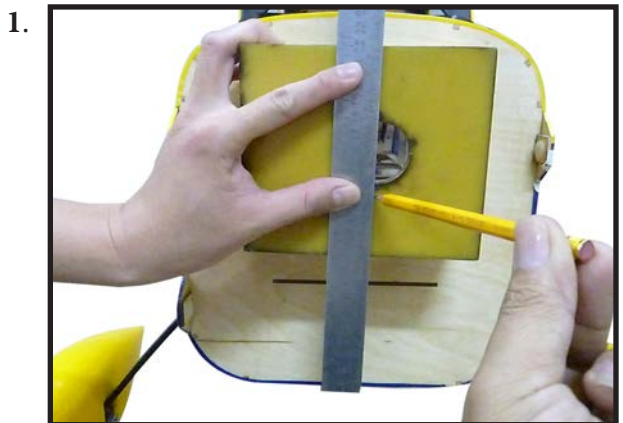
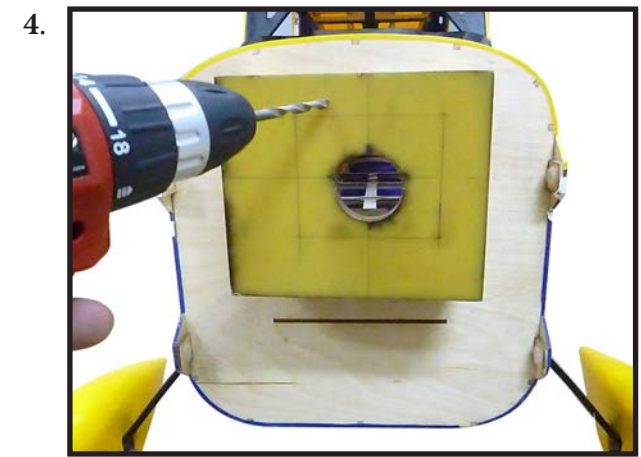

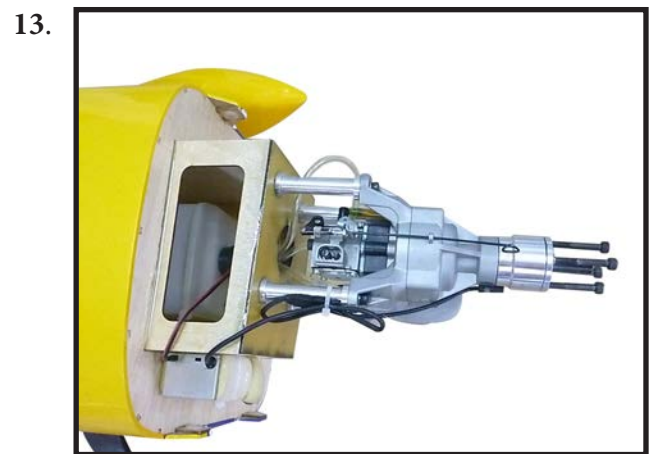
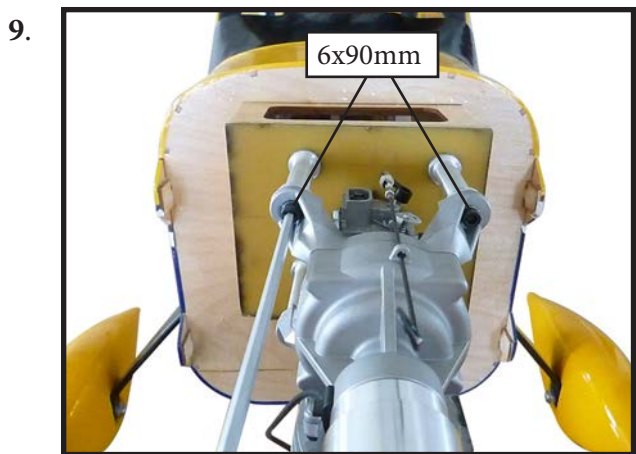
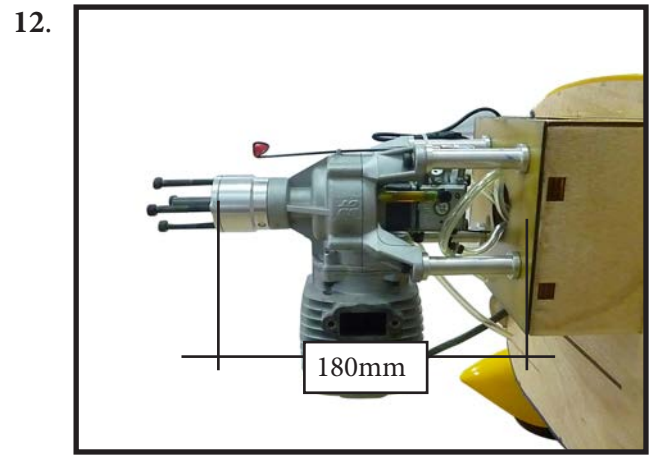
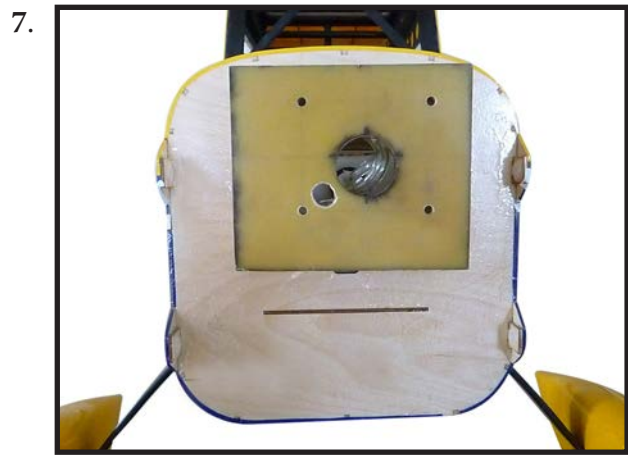
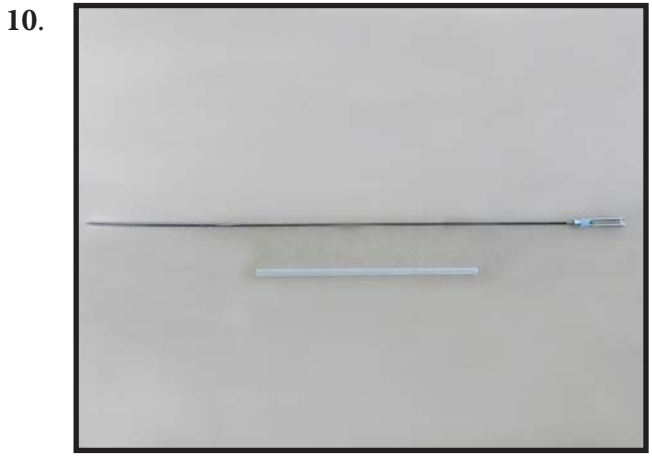
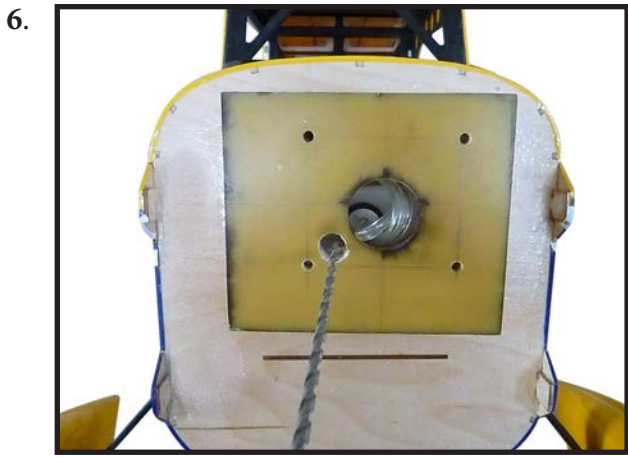

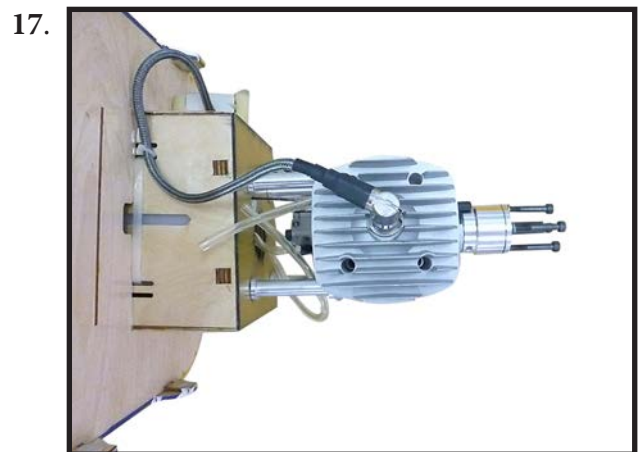
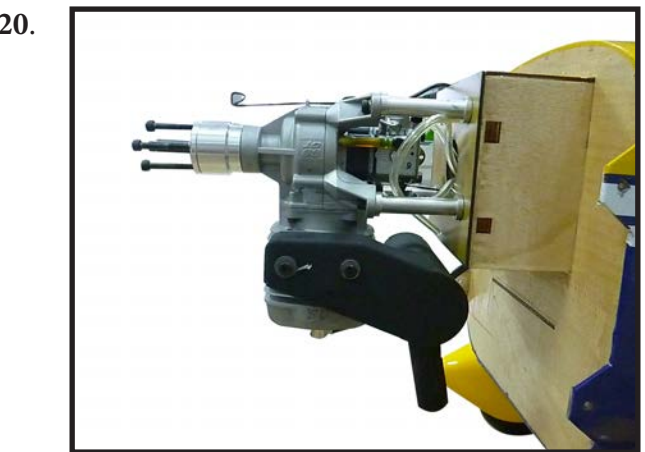
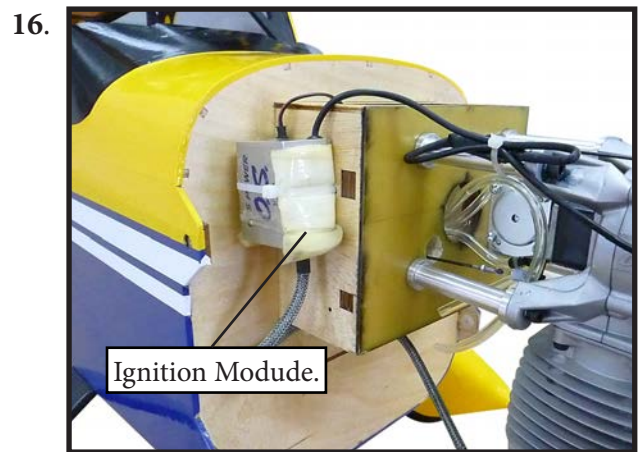
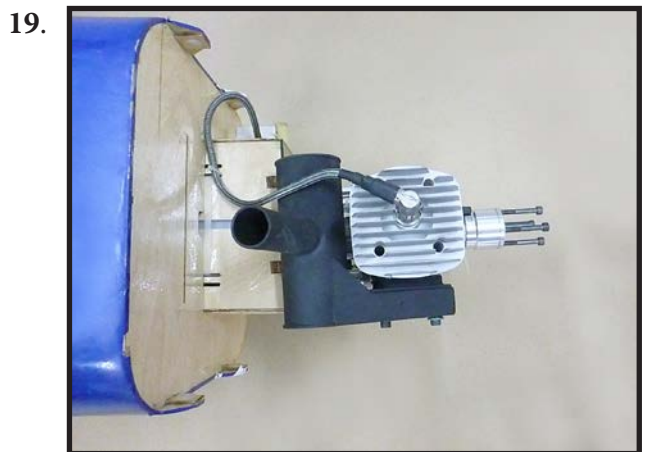
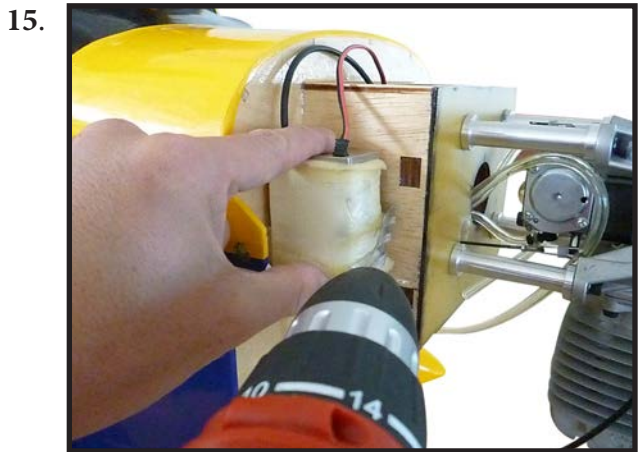
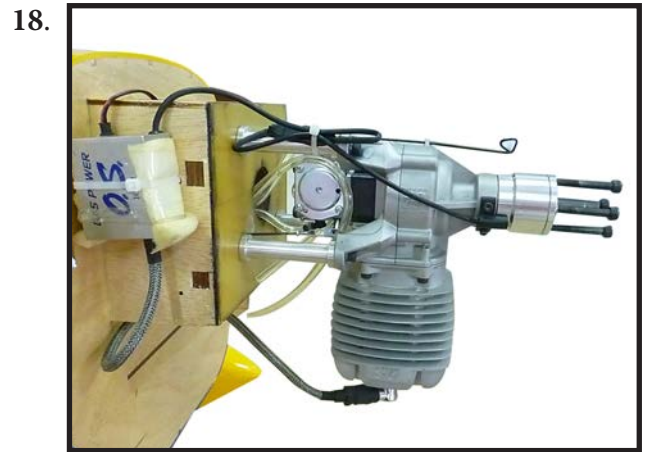
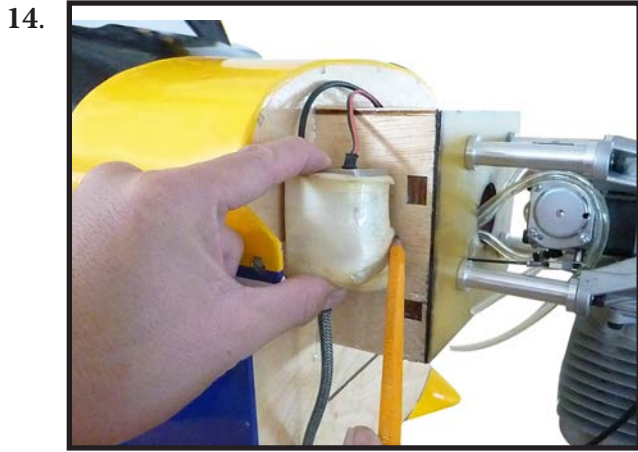

**THROTTLE SERVO ARM  
INSTALLATION**

Install adjustable servo connector in the servo arm as same as picture below:

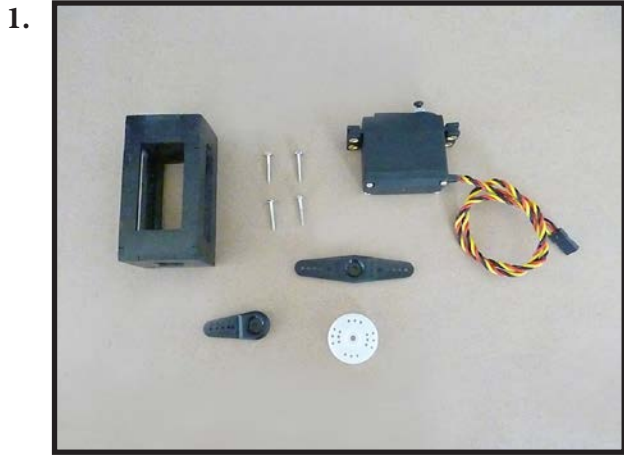

Move the throttle stick to the closed position and move the carburetor to closed. Use a 2.5mm hex wrench to tighten the screw that secures the throttle pushrod wire. Make sure to use threadlock on the screw so it does not vibrate loose.

Reinstall the servo horn by sliding the connector over the pushrod wire. Center the throttle stick and trim and install the servo horn perpendicular to the servo center line.

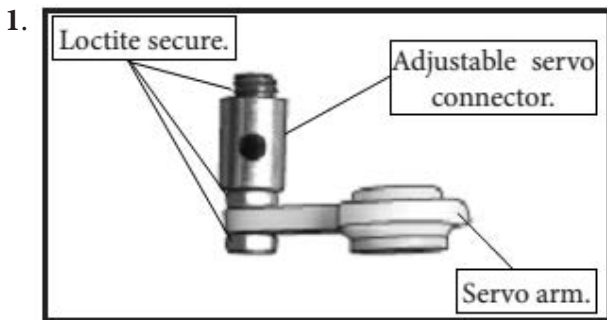

## COWLING

Please see below pictures.



2.

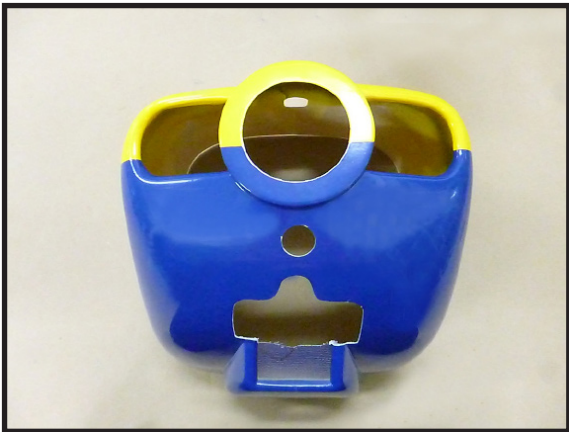

6.



3.



7.

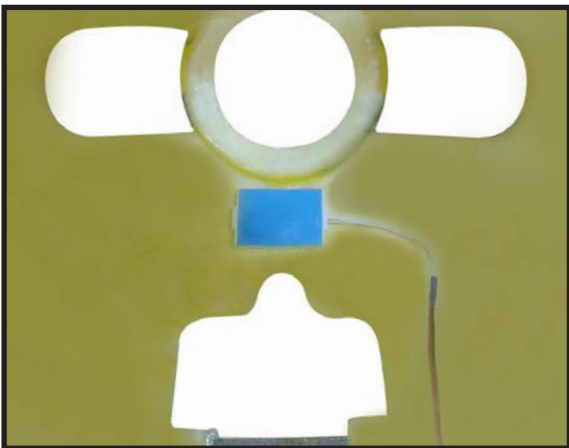

4.

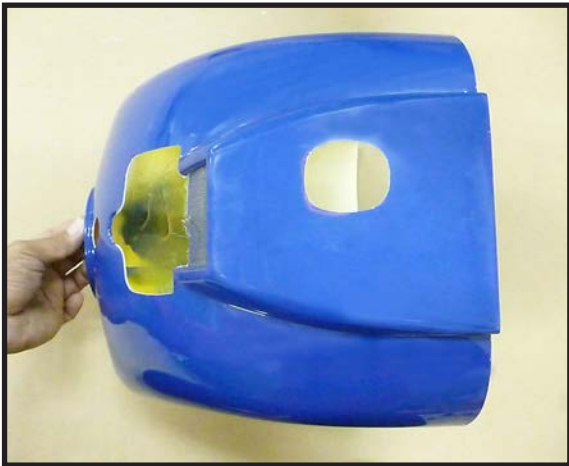

8.



5.



9.

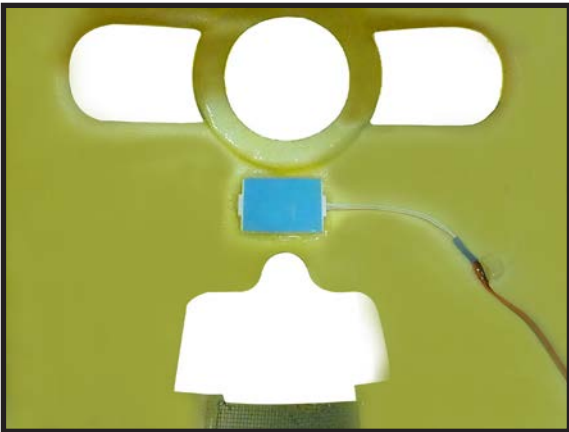



Tape the cowl to the fuselage using low-tack tape.



Use a drill and drill bit to drill the holes for the cowl mounting screws. Make sure the cowl position is correct before drilling each hole.



Install the muffler and muffler extension onto the engine and make the cutout in the engine for muffler clearance. Connect the fuel and pressure lines to the carburetor, muffler and fuel filter valve. Secure the cowl to fuselage using the M4x25mm socket head screws. Putting a small length of silicon fuel tube under the head of the screw helps with vibration.



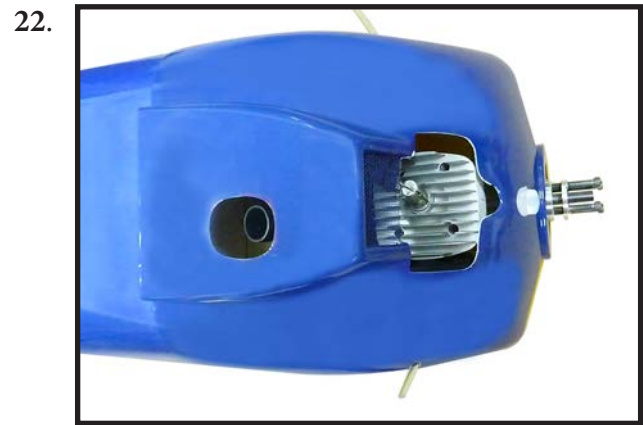
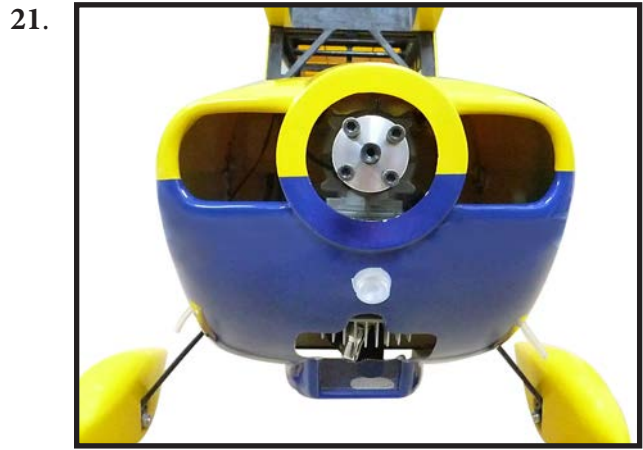
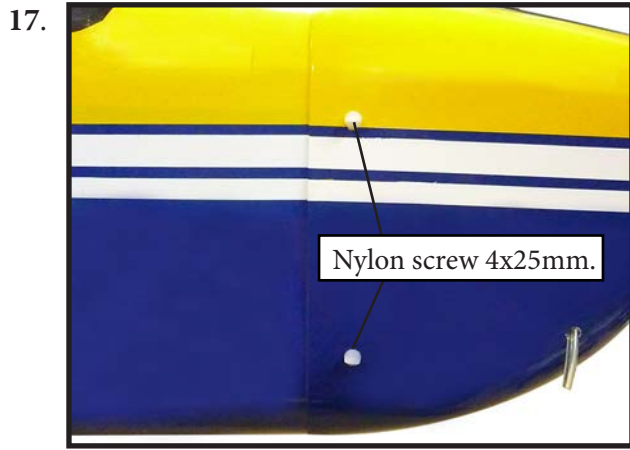

**ELECTRIC POWER CONVERSION**

Locate the items necessary to install the electric power conversion included with your model.



Recommend the items necessary to install the electric power conversion parts included with your model.



- Motor: 80cc - 195 KV
- Propeller: 27 x 10
- ESC: 200A
- 12S- 14S Lipo

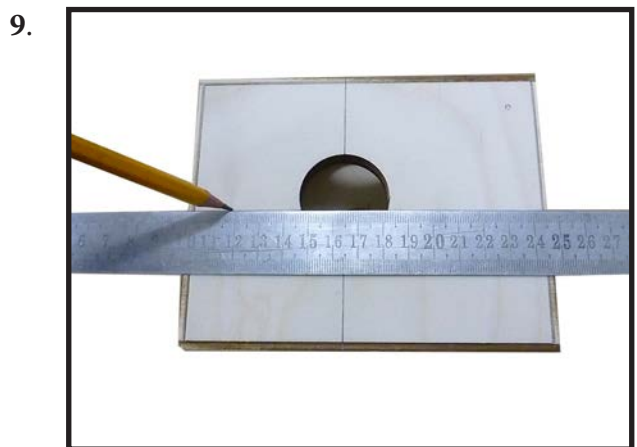
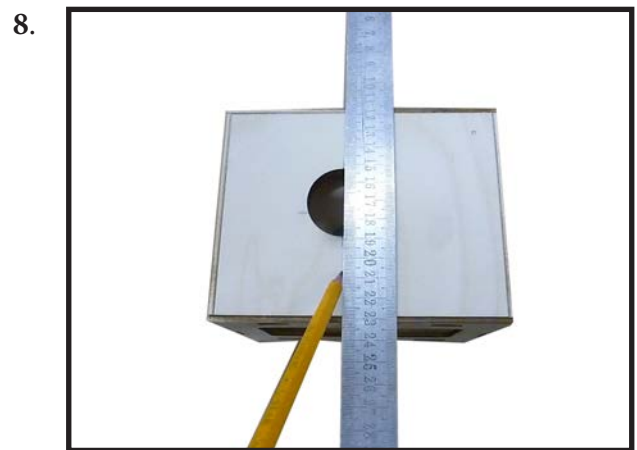
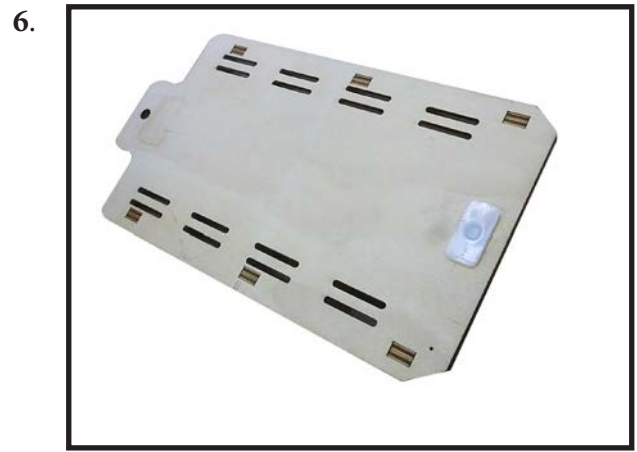
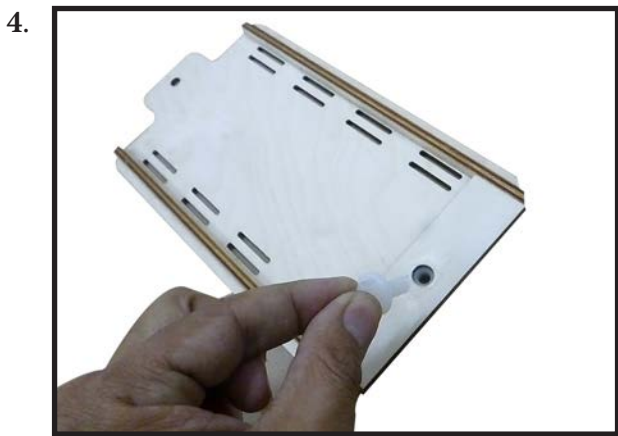
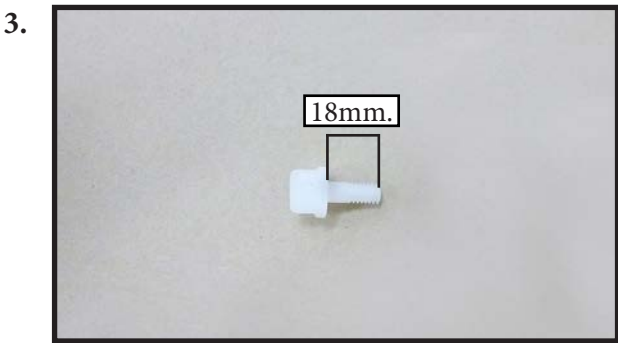

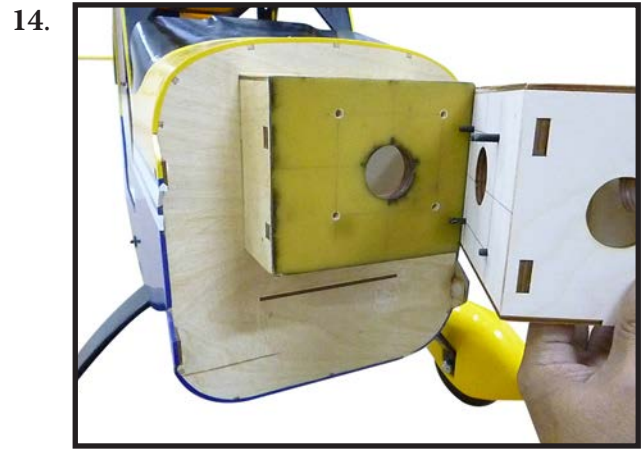
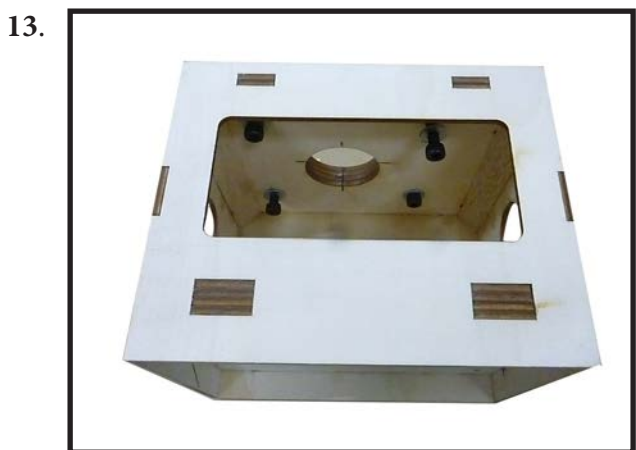
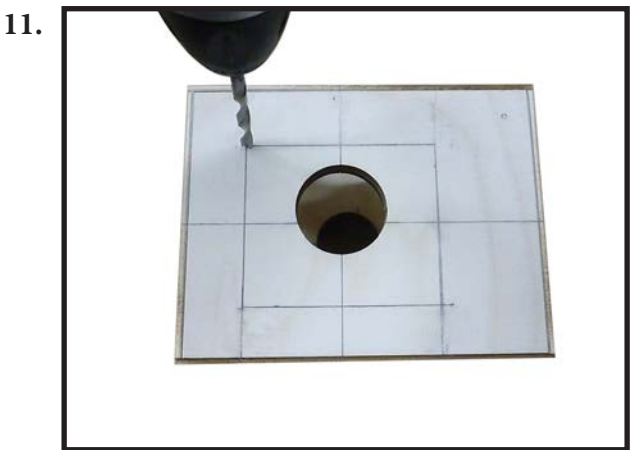

Attach the electric motor box to the firewall centered with the cross lines drawn on the electric motor box and firewall. Using M6x25mm to secure the motor box to the firewall. Please see pictures below.

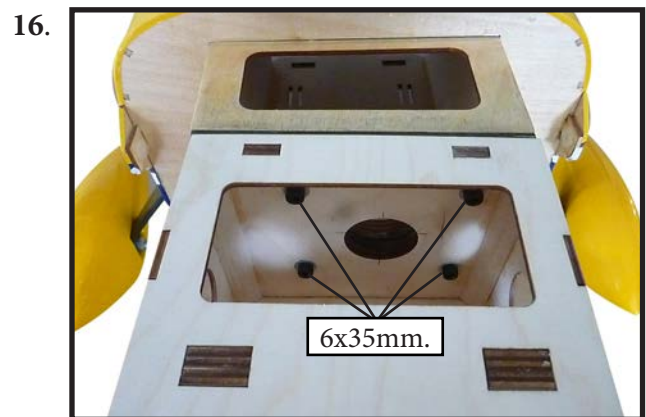

Attach the motor to the front of the electric motor box using four 4mm blind nut, four M6x35mm hex head bolts to secure the motor. Please see picture shown.

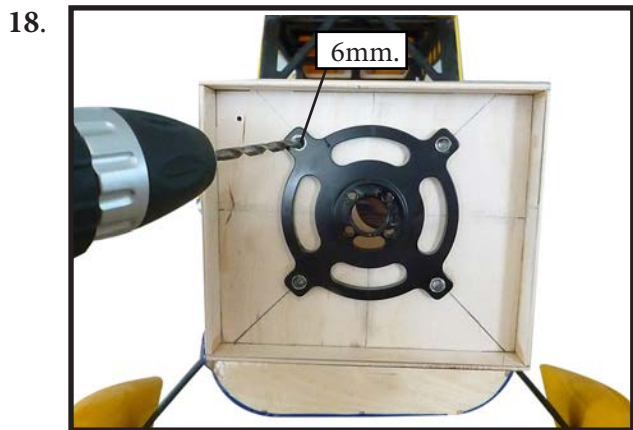

Then, use 8mm drill bit to enlarge the holes on the electric motor box.

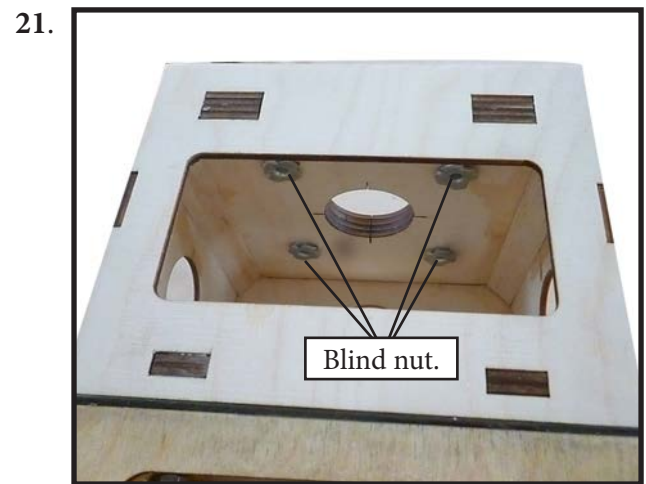
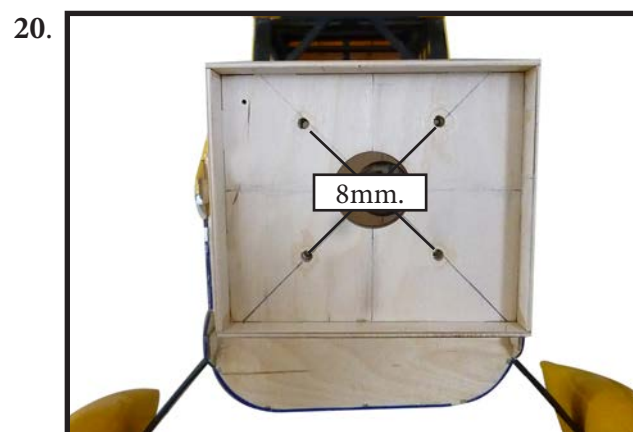

Attach the motor mount to the front of the electric motor box using four 4mm blind nut, four M6x25mm hex head bolts to secure the motor. Please see picture shown.

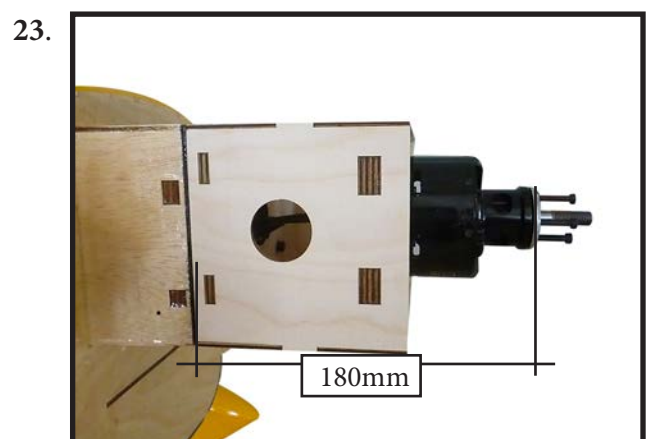
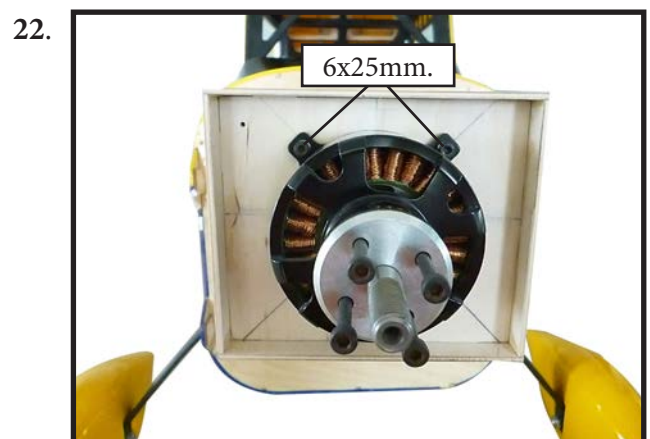

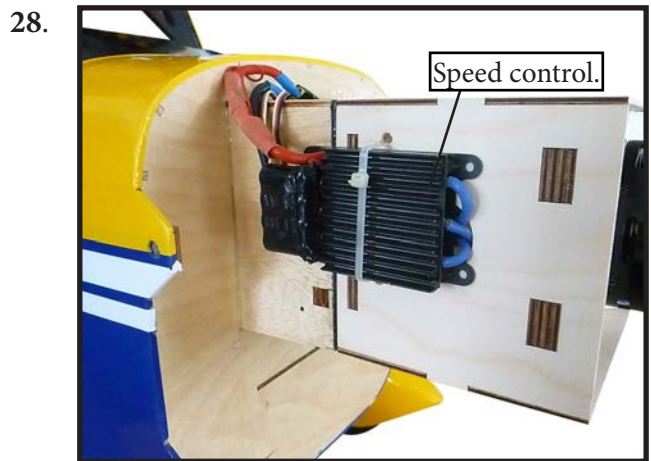
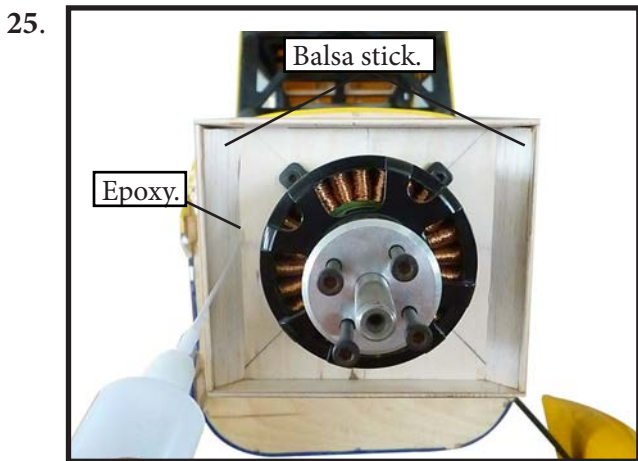
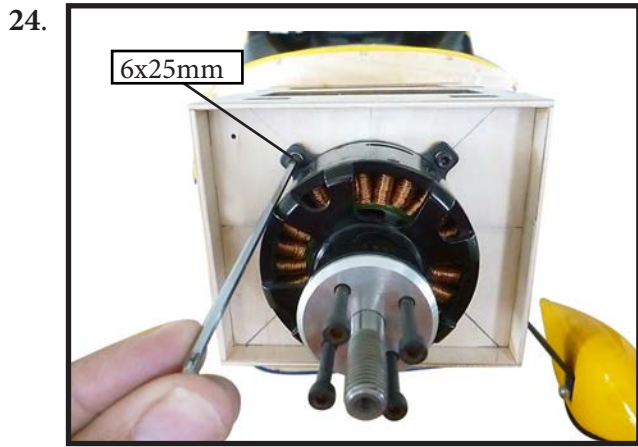

Attach the speed control to the side of the motor box using two-sided tape and tie wraps. Connect the appropriate leads from the speed control to the motor. Make sure the leads will not interfere with the operation of the motor.

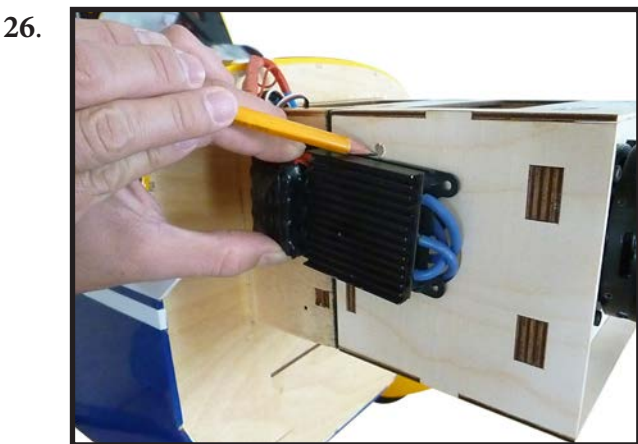

31.

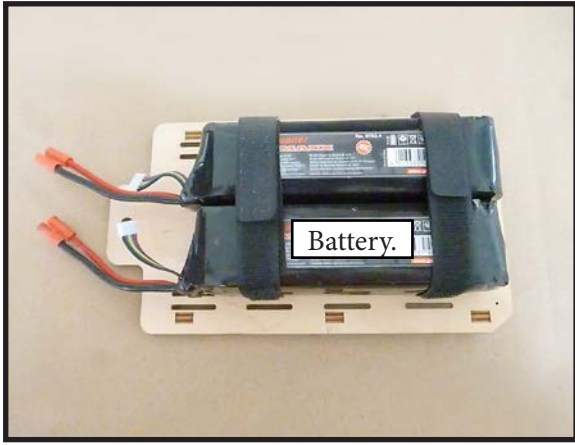

32.

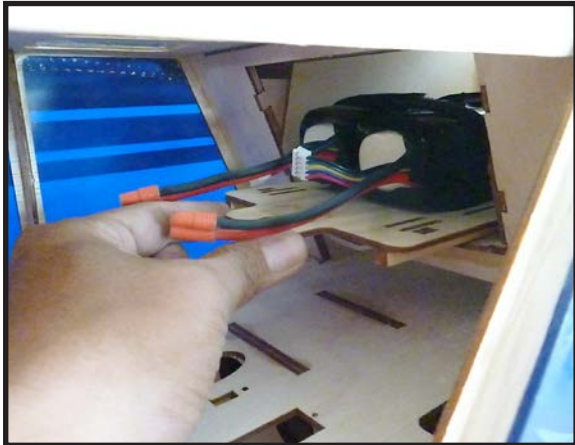

33.



34.

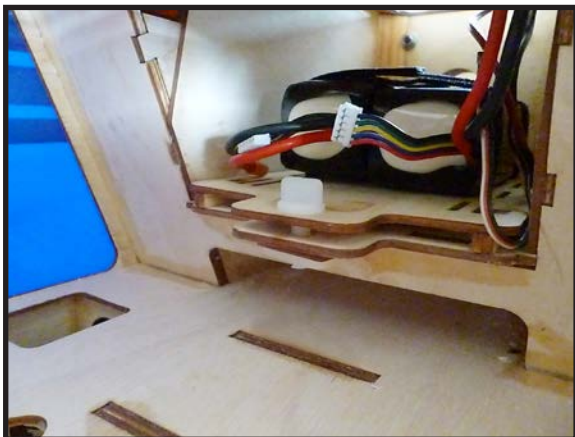

## INSTALLING THE SPINNER

Install the spinner backplate, propeller and spinner cone.

1.



⚠ The propeller should not touch any part of the spinner cone. If it does, use a sharp modeling knife and carefully trim away the spinner cone where the propeller comes in contact with it.

2.



## INSTALL NAIL HINGE ELEVATOR

Test fit the hinges into the elevator, and then the hinges into the tail. Ensure that the hinge pockets line up, and that the hinges move freely.

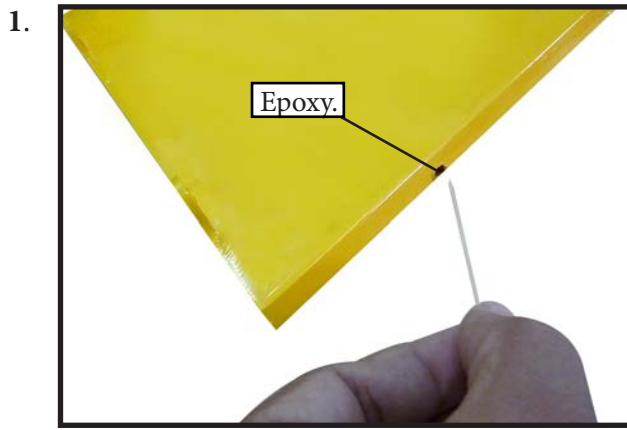

**INSTALL ELEVATOR CONTROL HORN**

Install the elevator control horn using the same method as same as the elevator control horns.

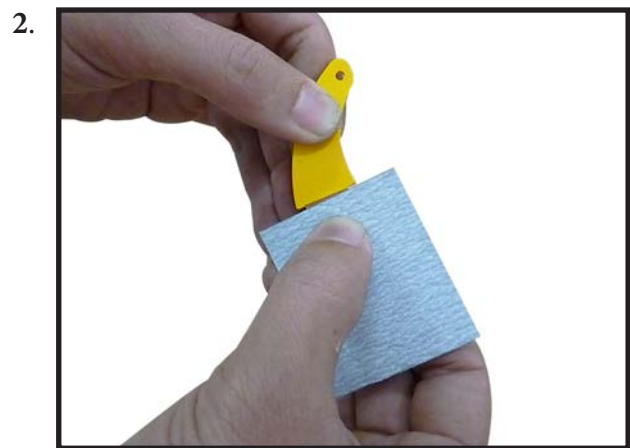
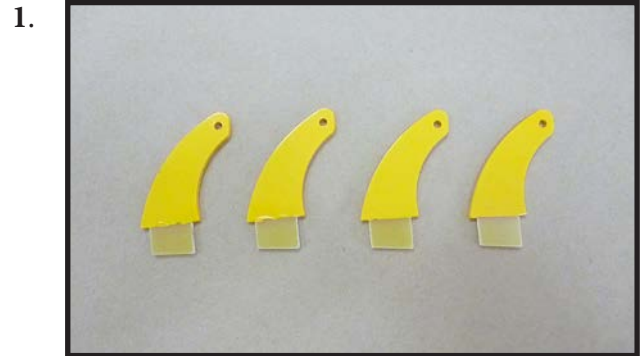

## INSTALL NAIL HINGE RUDDER

Test fit the hinges into the rudder, and then the hinges into the tail. Ensure that the hinge pockets line up, and that the hinges move freely.

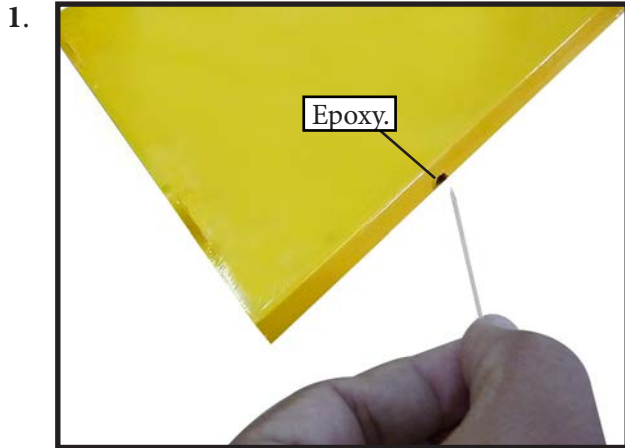

Plug in the power cord

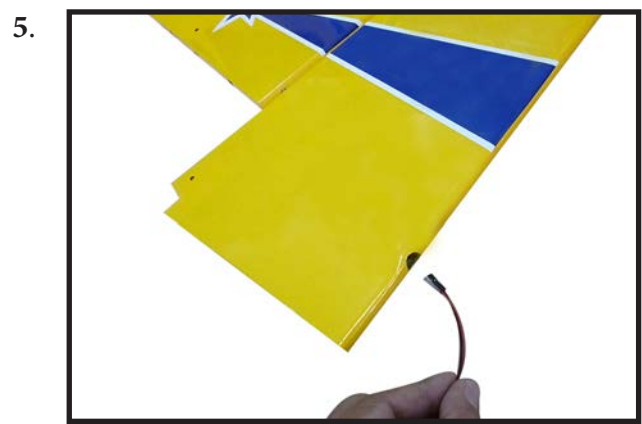

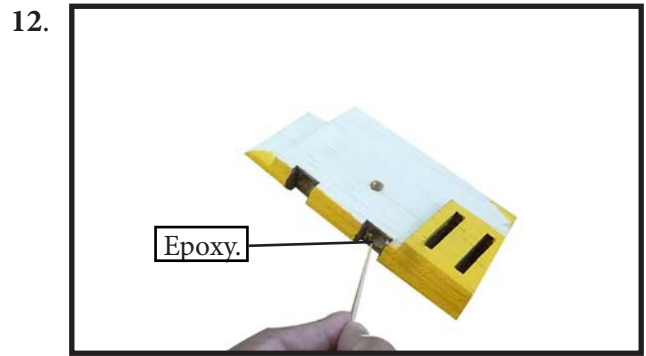
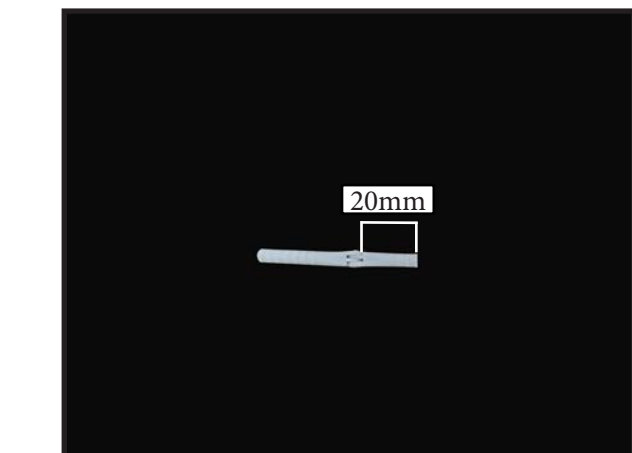
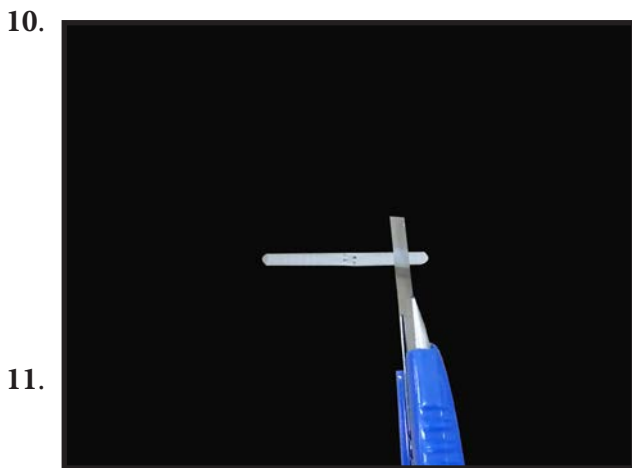
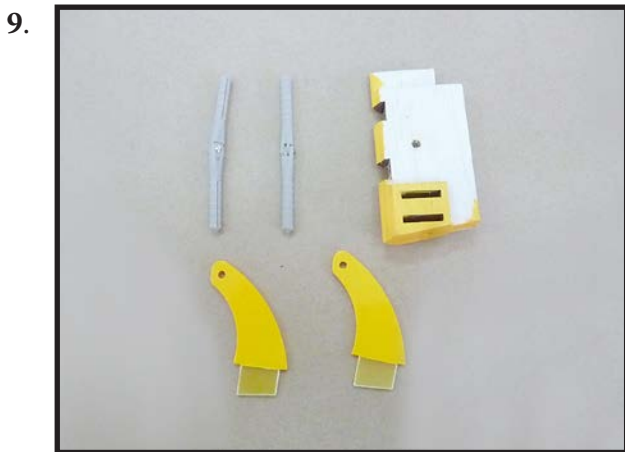

**INSTALL RUDDER CONTROL HORN**

Install the elevator control horn using the same method as same as the aileron control horns.





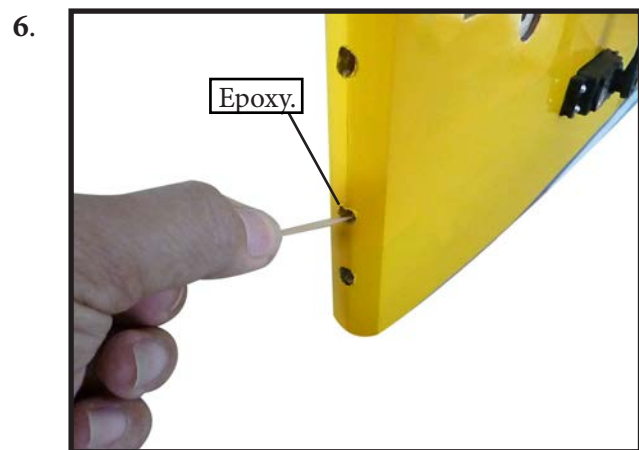
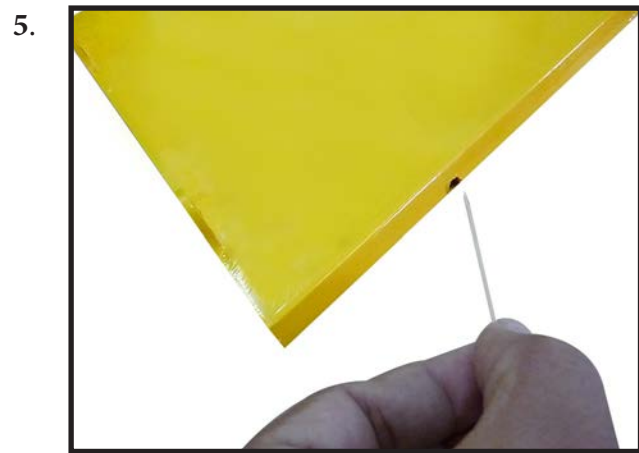
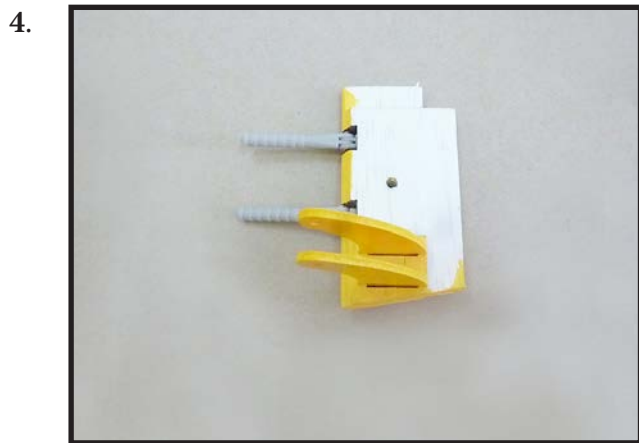

**INSTALLING WING TUBE VERTICAL STABILIZER**

Parts requirement. See pictures below.



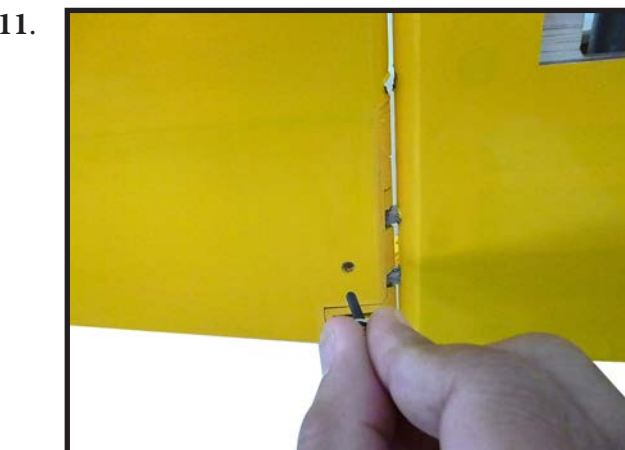
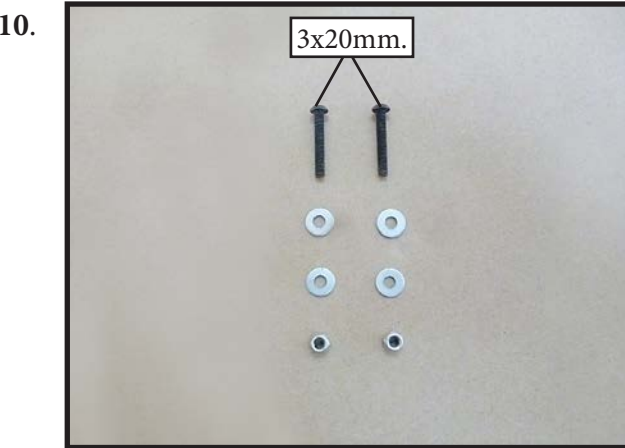

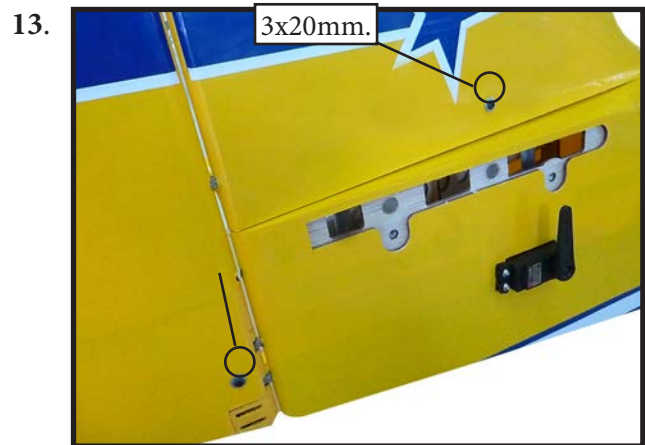
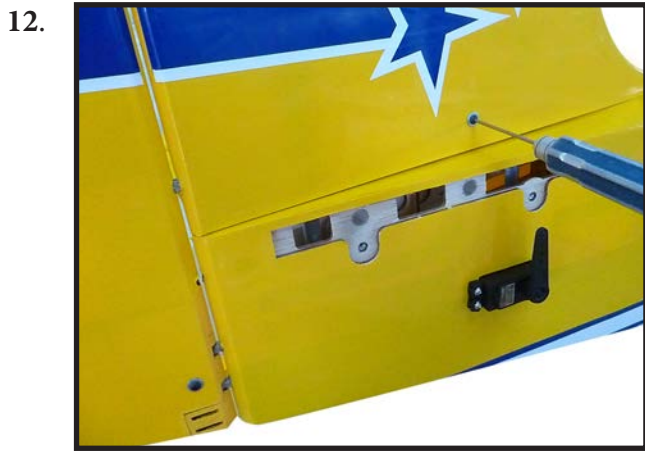

**INSTALLING HORIZONTAL STABILIZER**

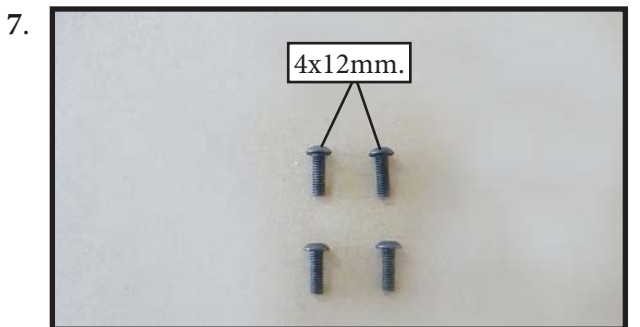
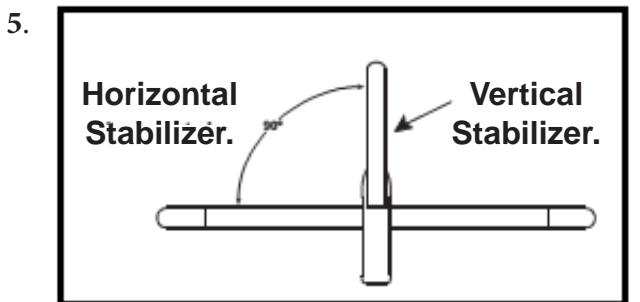

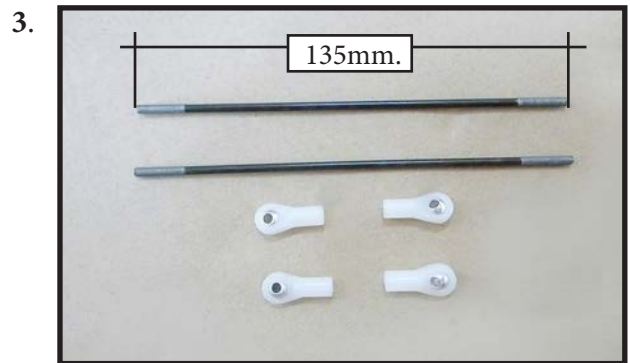
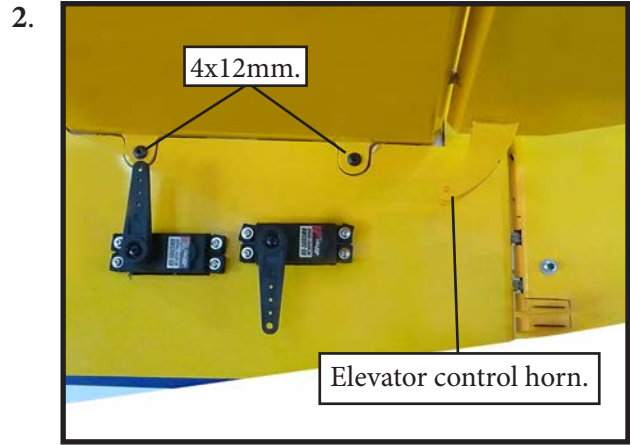
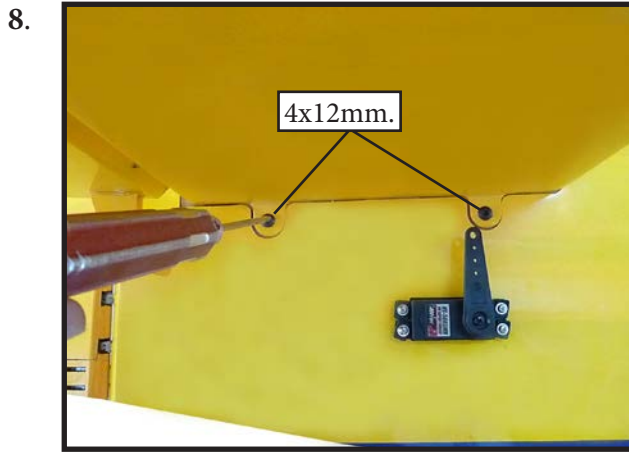

**ELEVATOR PUSHROD HORN  
INSTALLATION**

Install the elevator control horn using the same method as with the aileron control horns.

Position the elevator control horn on the both side of elevator.

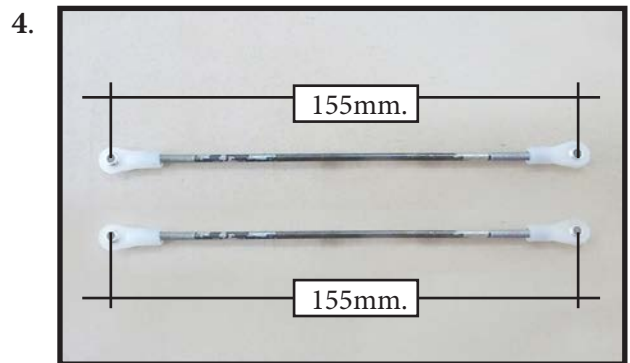

**RUDDER PUSHROD INSTALLATION**

Repeat steps as same as steps done for elevator.

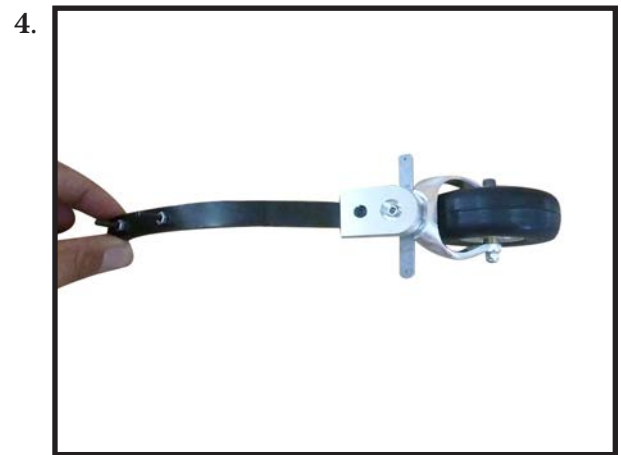
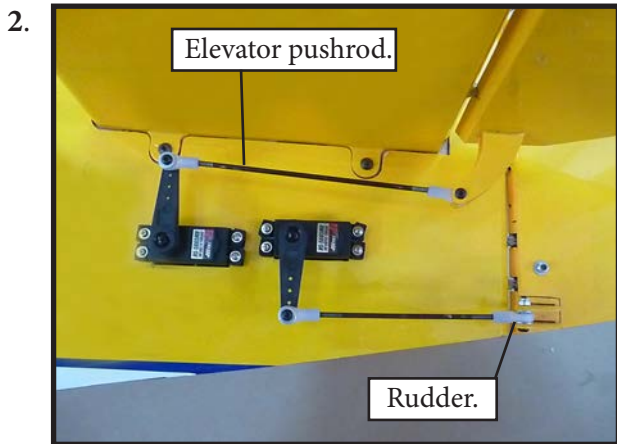
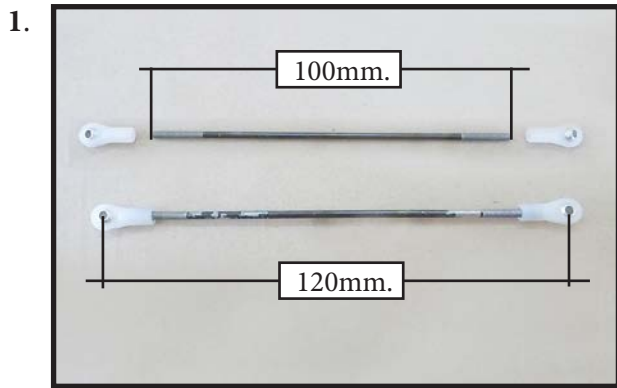

**MOUNTING THE TAIL WHEEL**

Locate items necessary to install tail wheel.

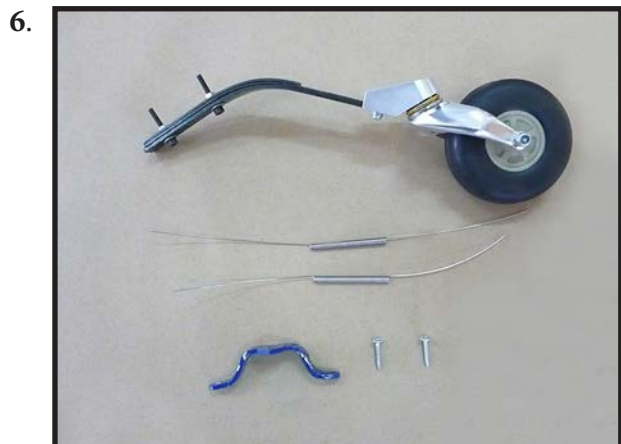
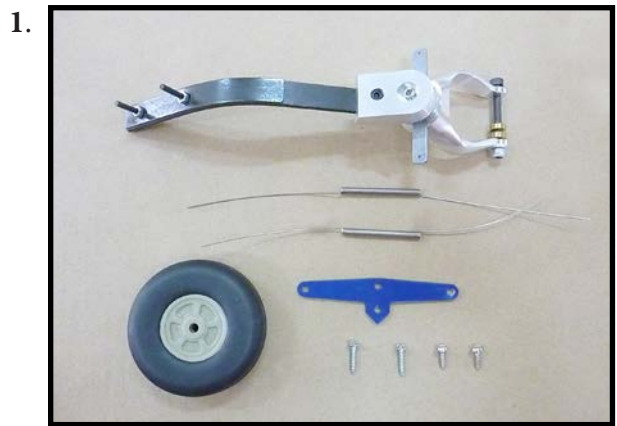

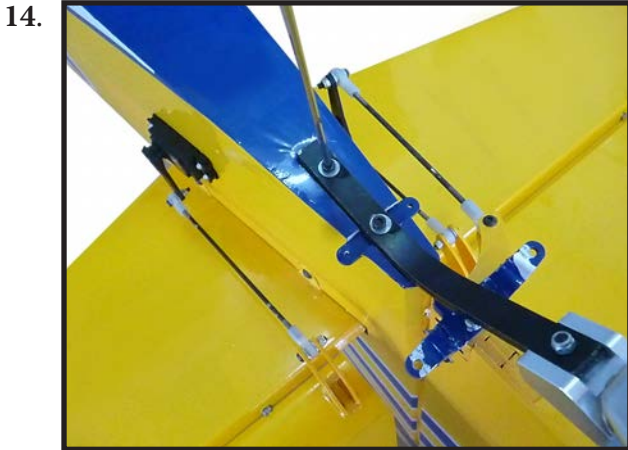
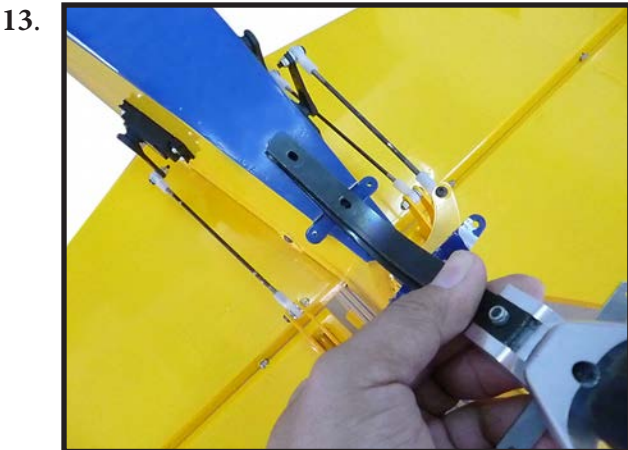
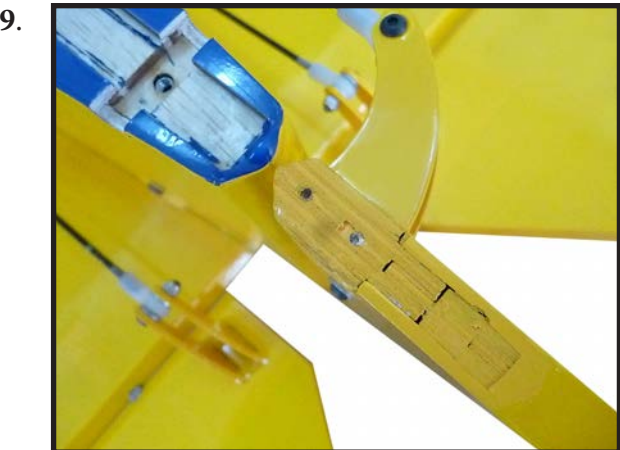
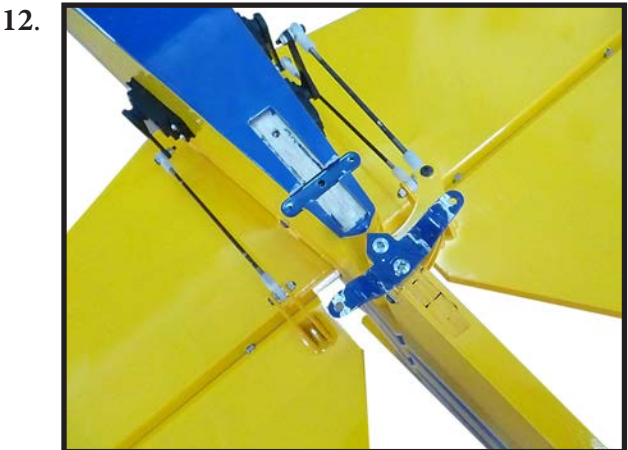
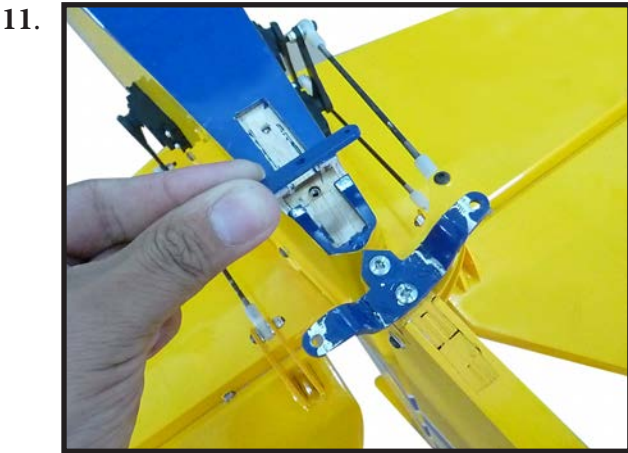

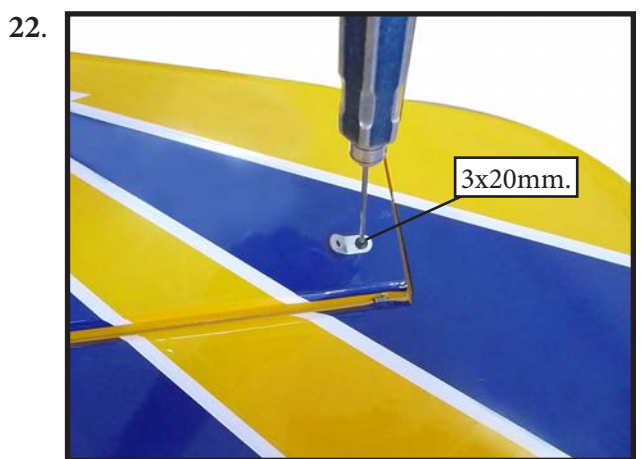
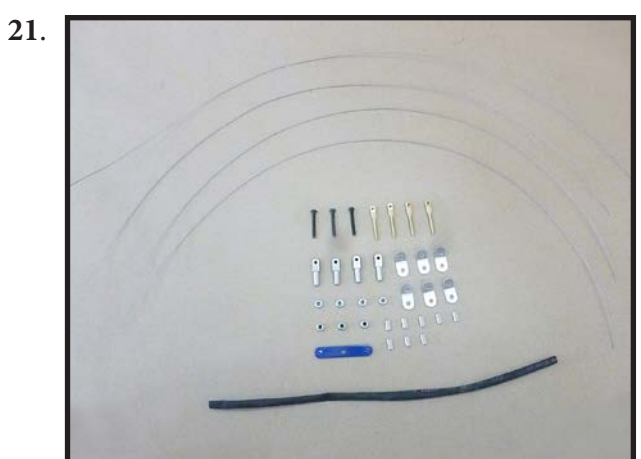
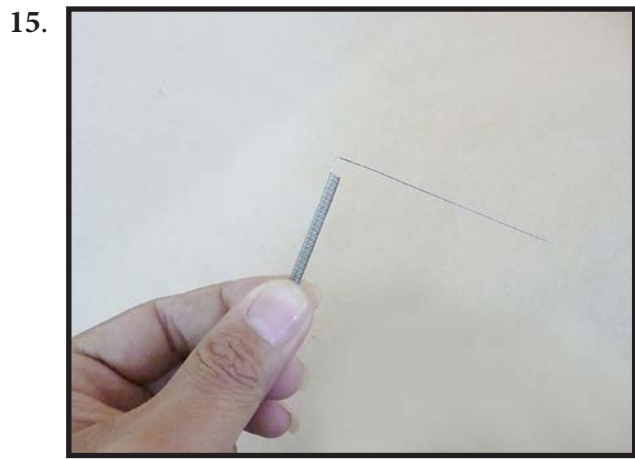

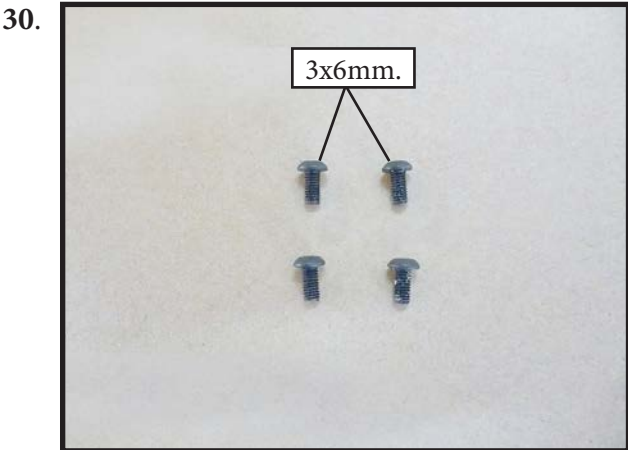
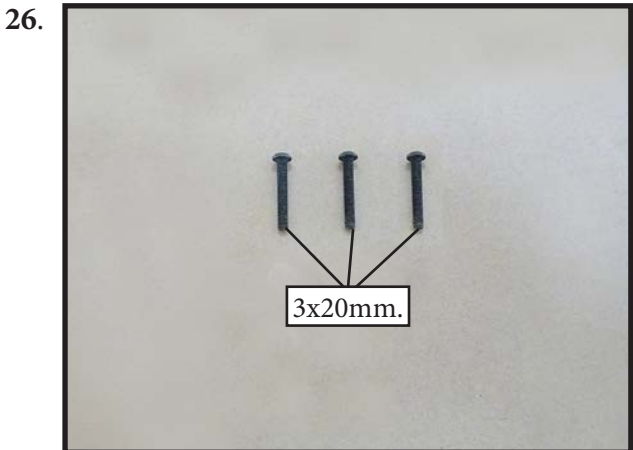
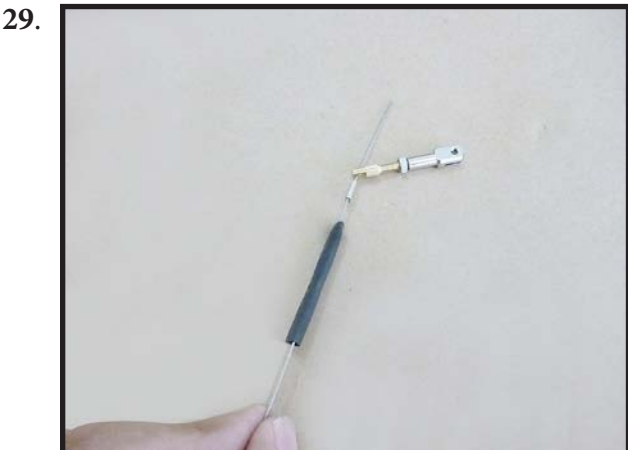



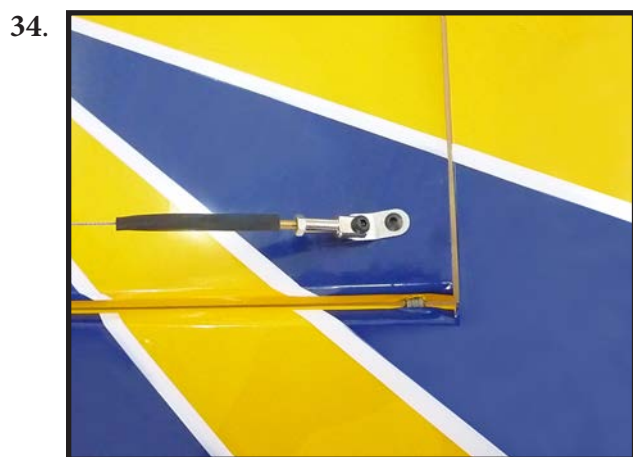
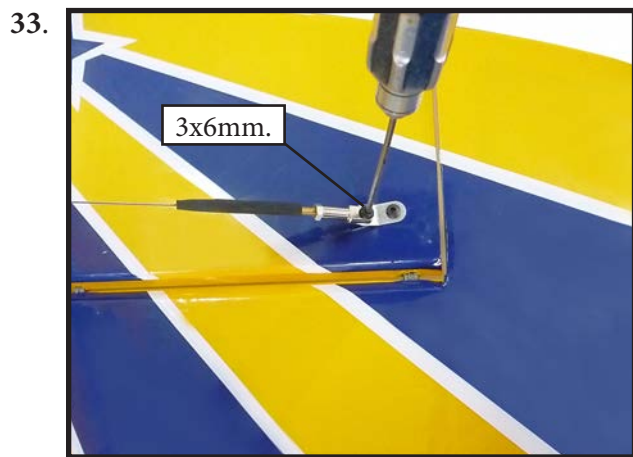
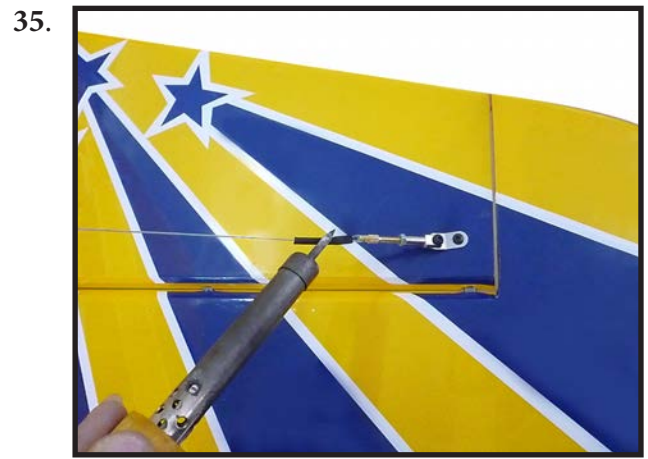

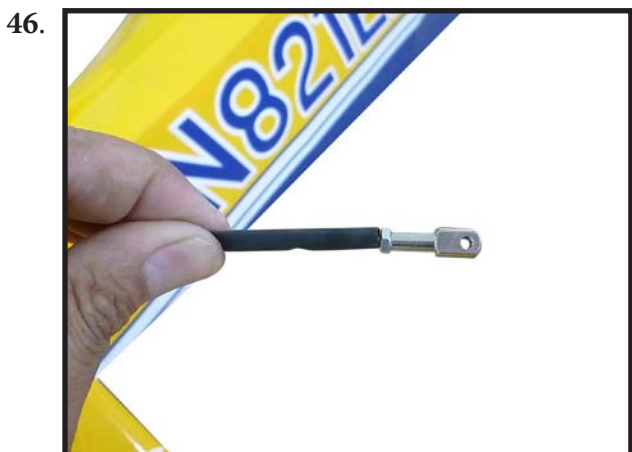
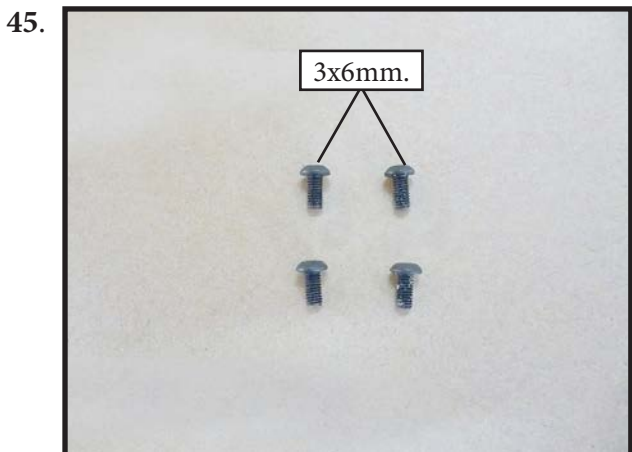
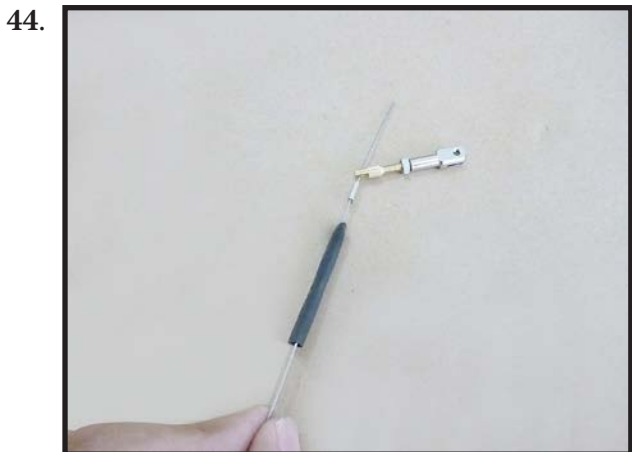

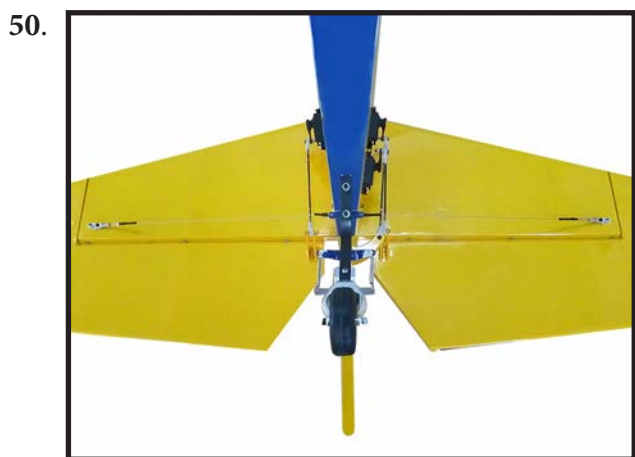
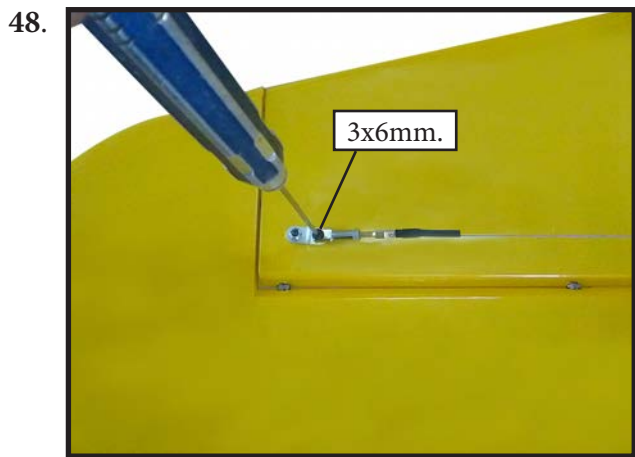

**INSTALLING THE WING STRUT**

Parts requirement. See pictures below.

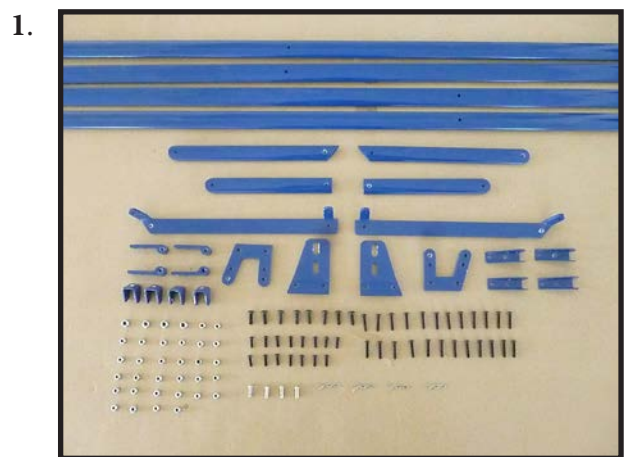

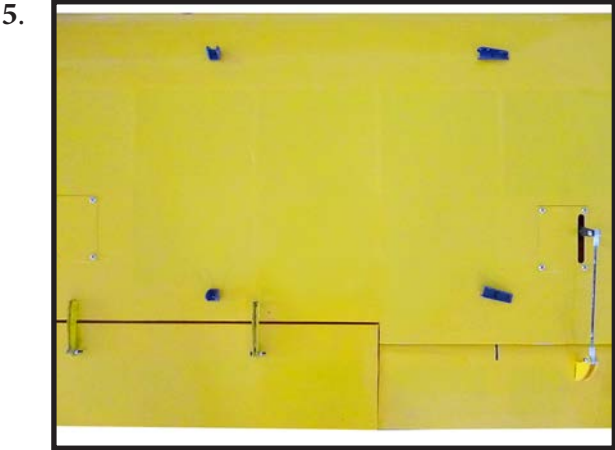
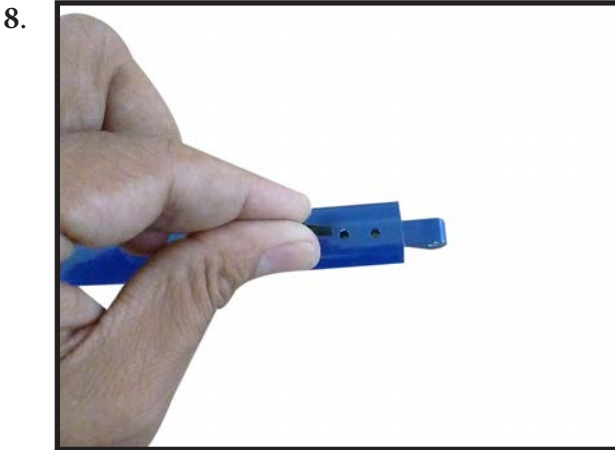
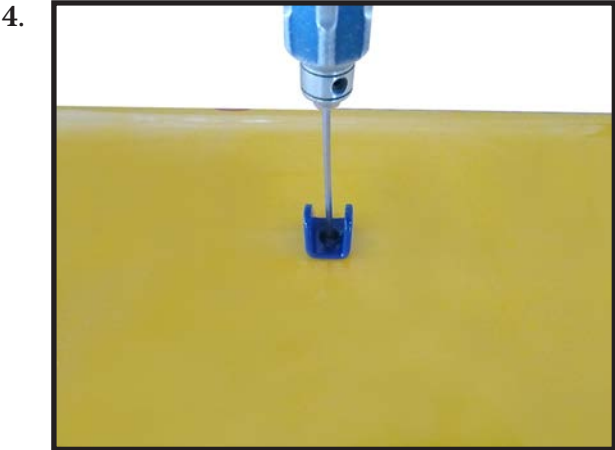
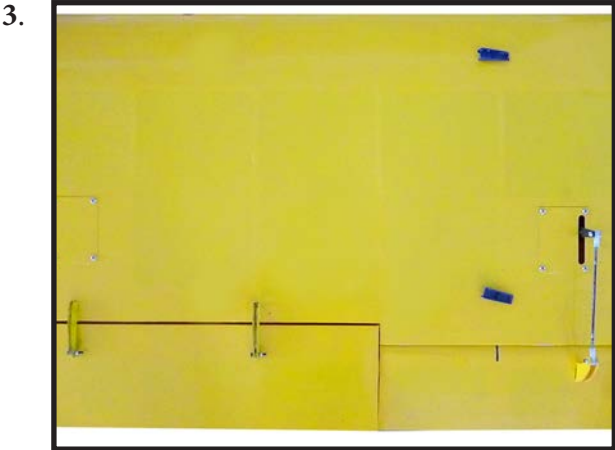
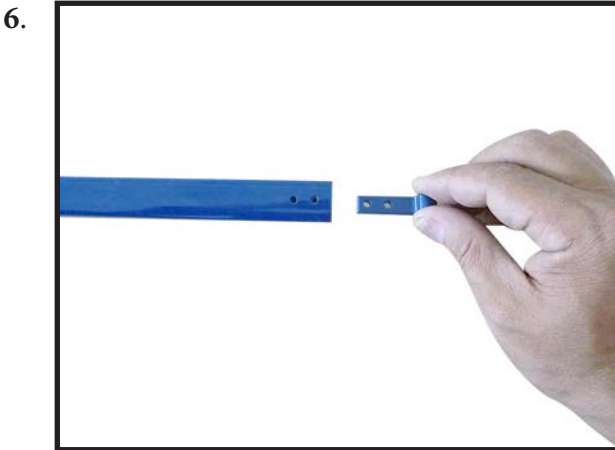
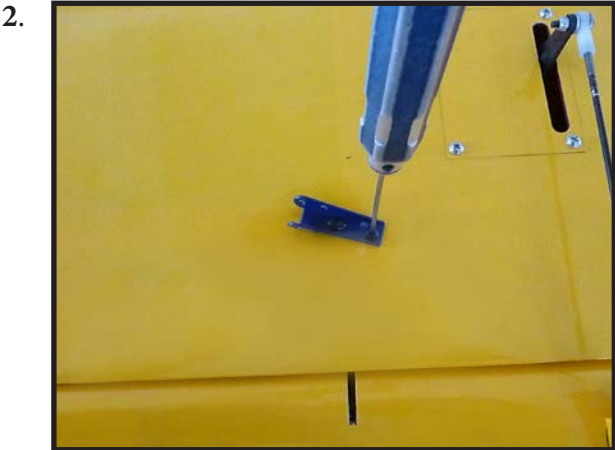

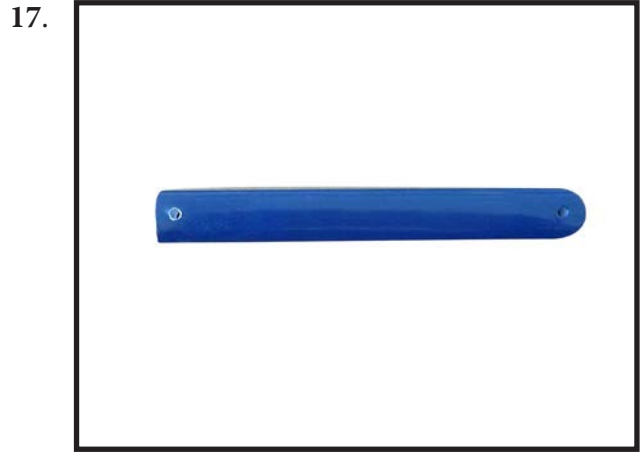
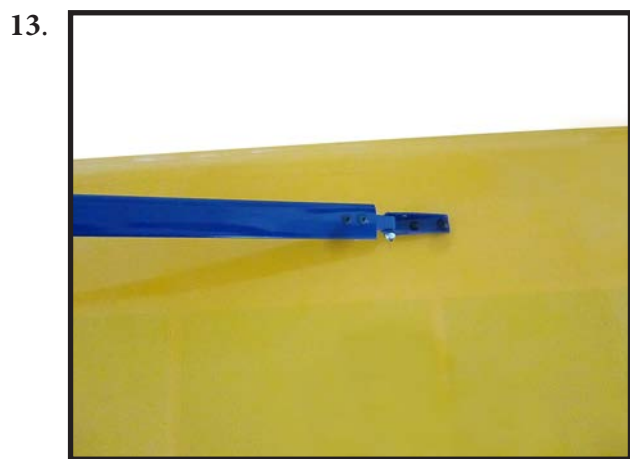
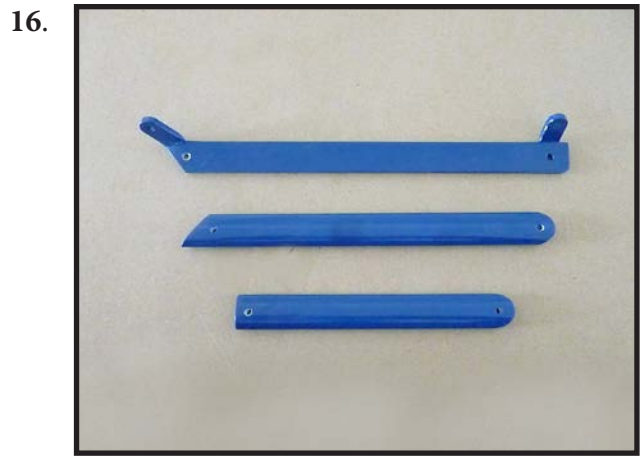
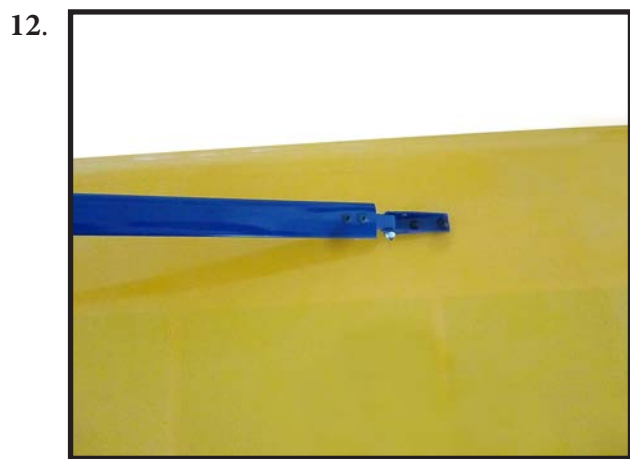
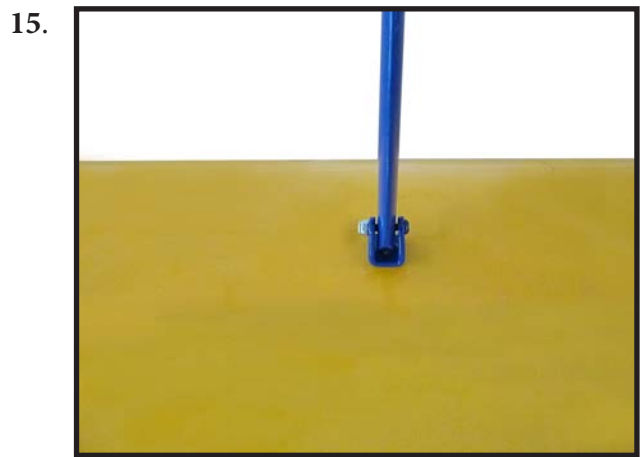
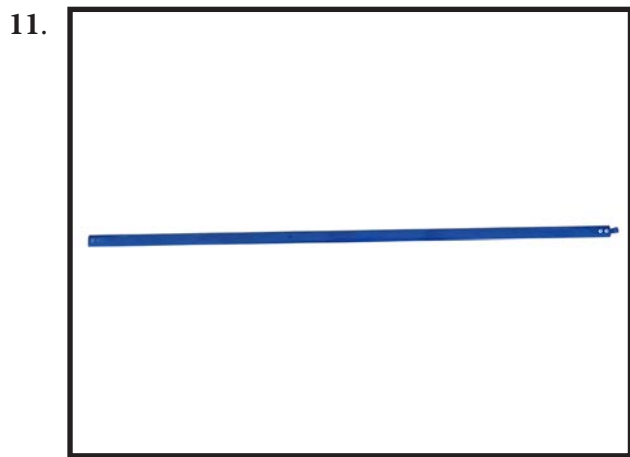
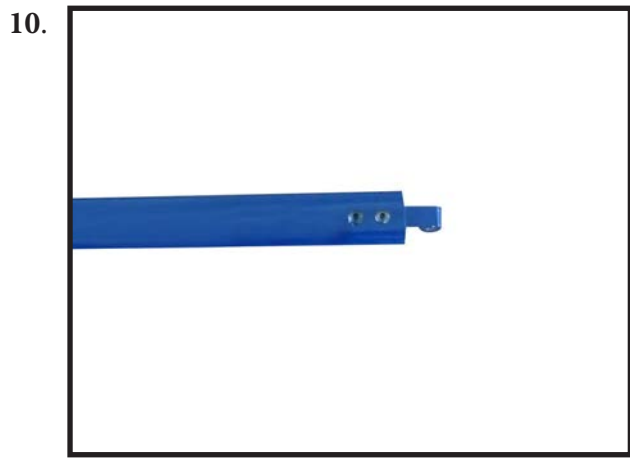

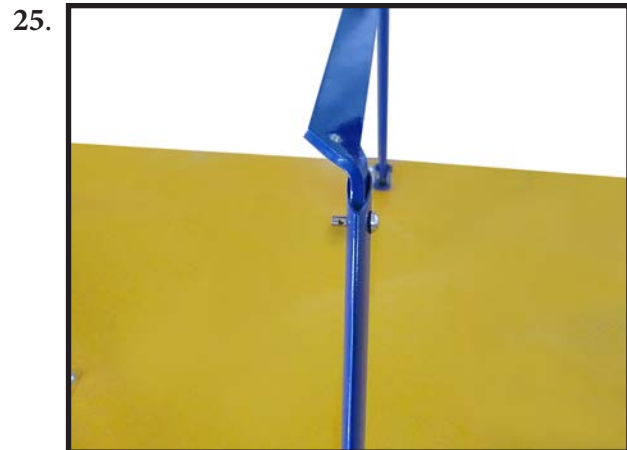
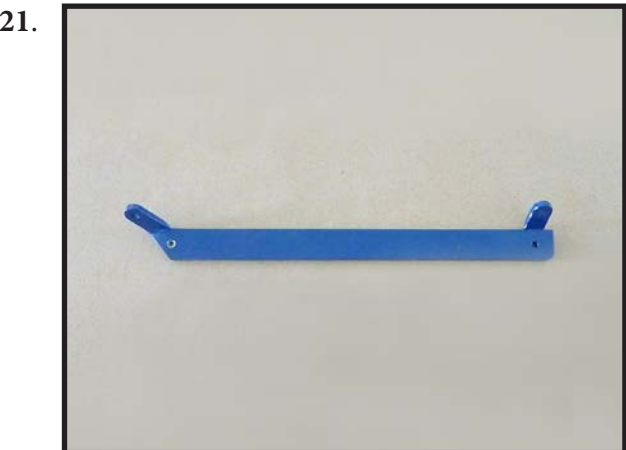
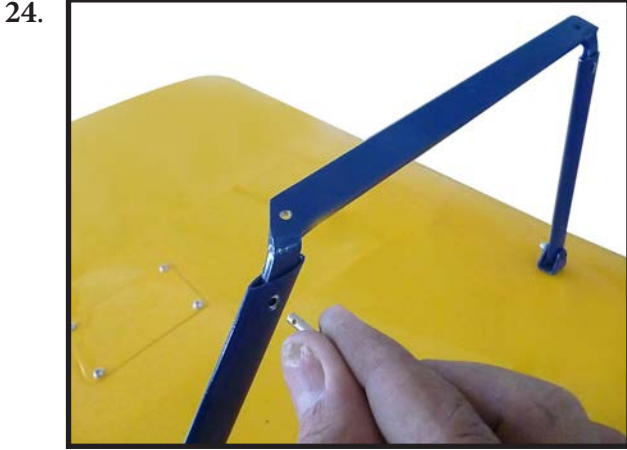
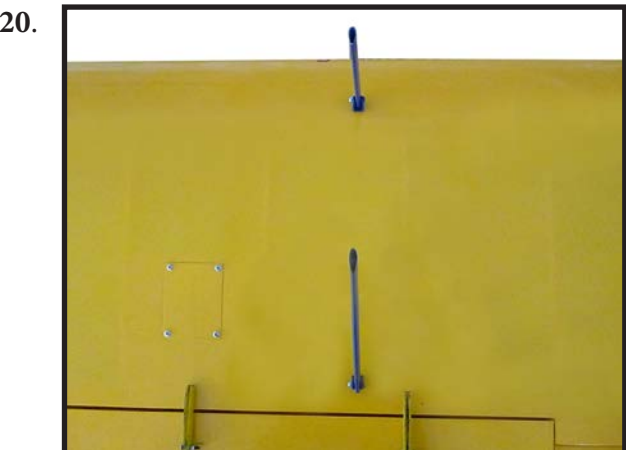
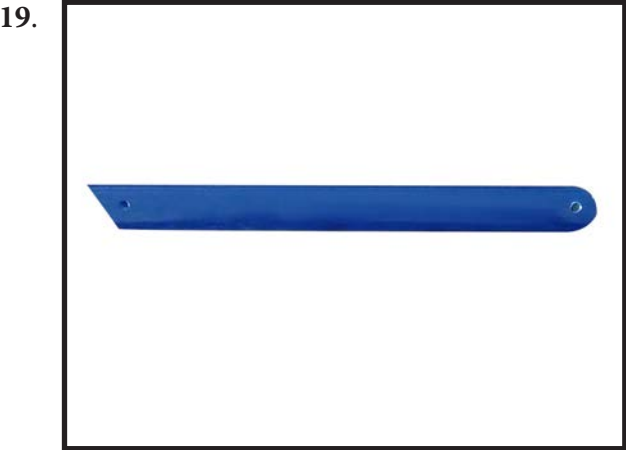
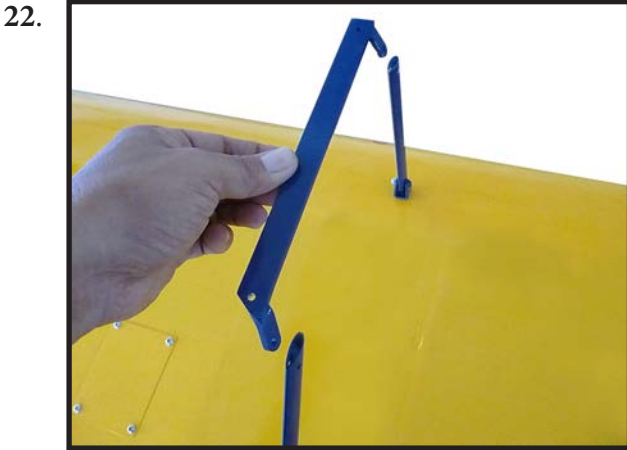

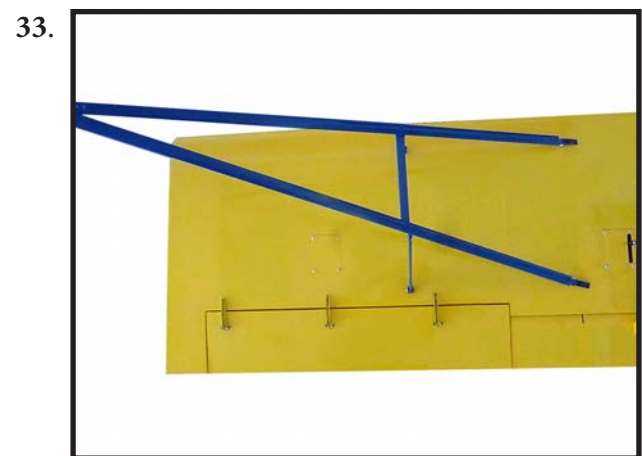
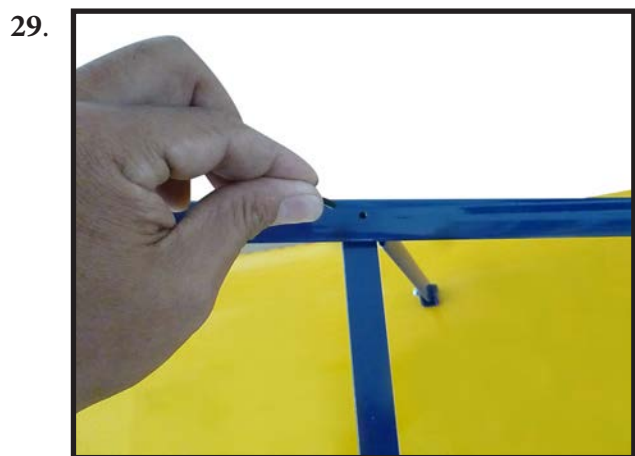
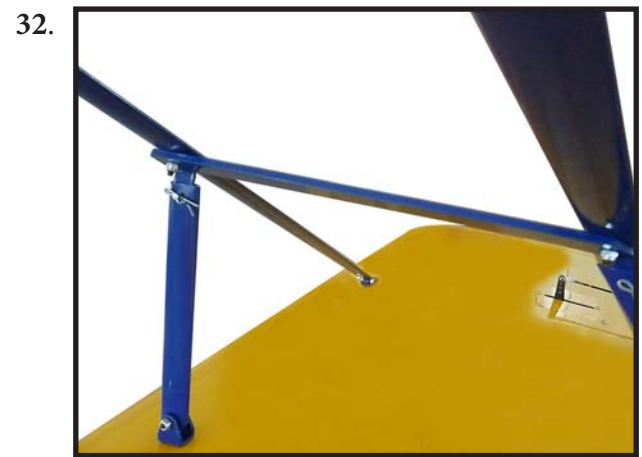

34.

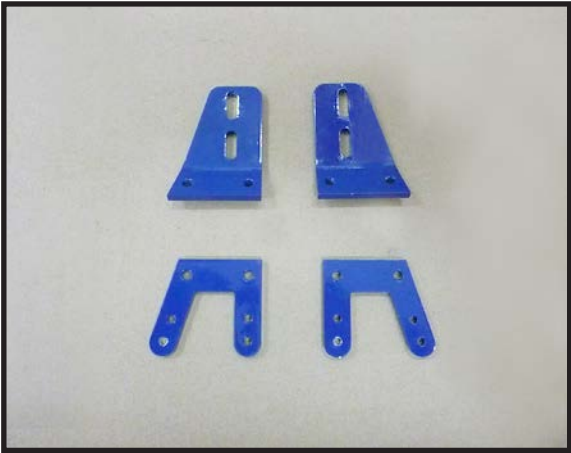

38.

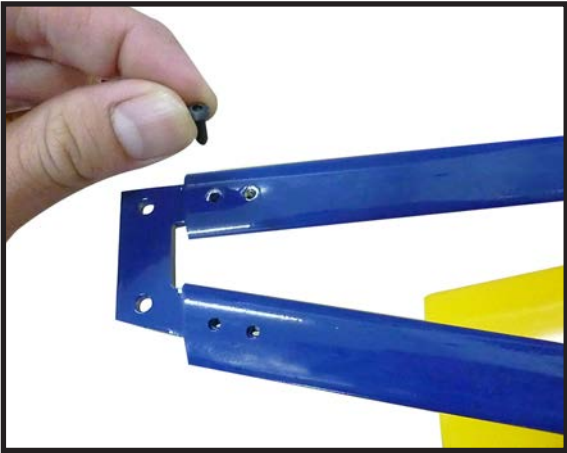

35.



39.



36.



40.



37.



41.





42.



46.

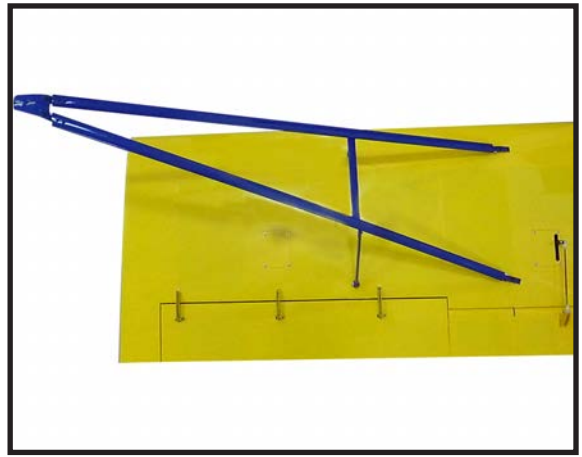

43.

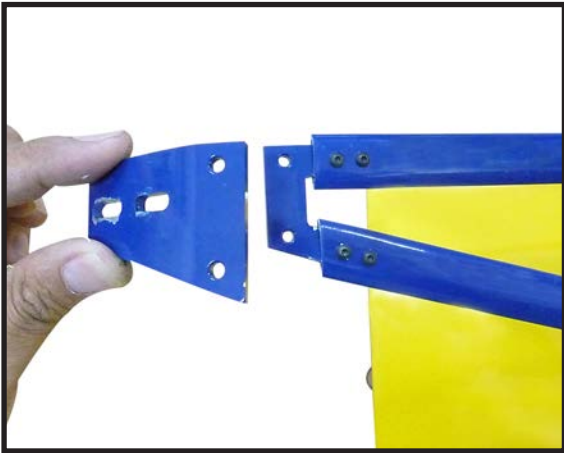

44.

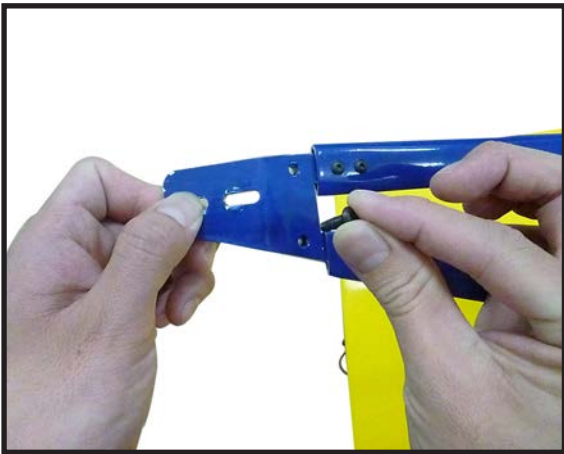

45.



**INSTALL THE WINDOW**

Parts requirement. See pictures below.

1.



2.

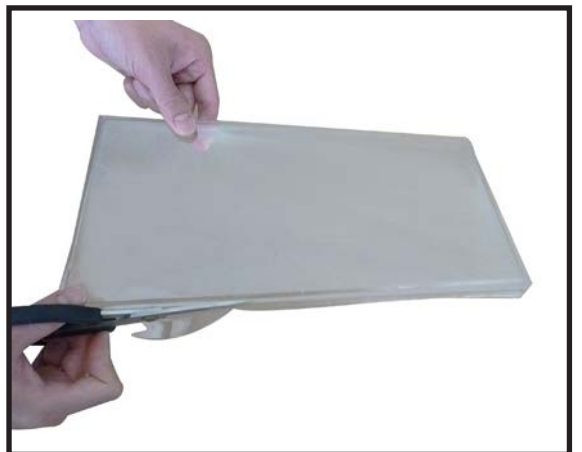

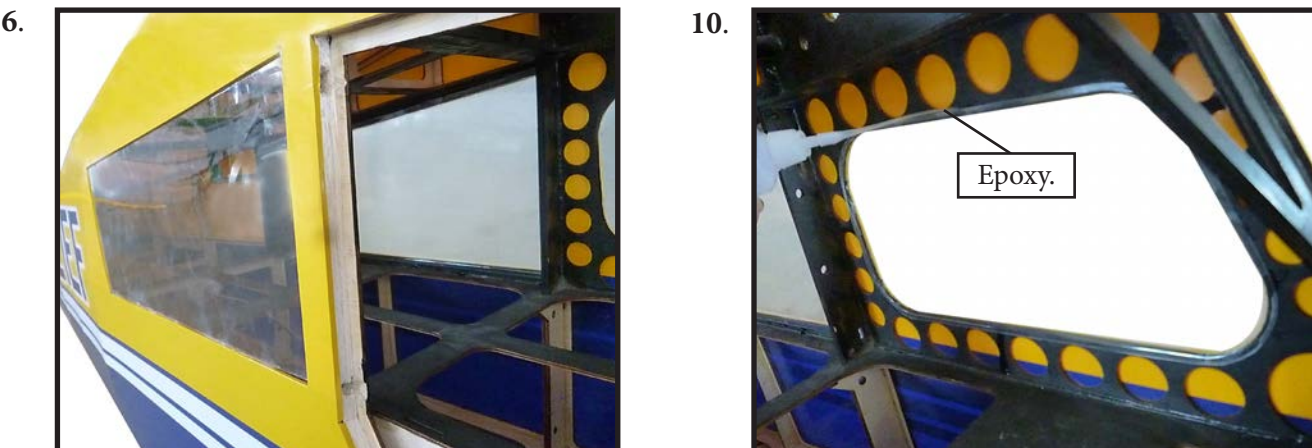
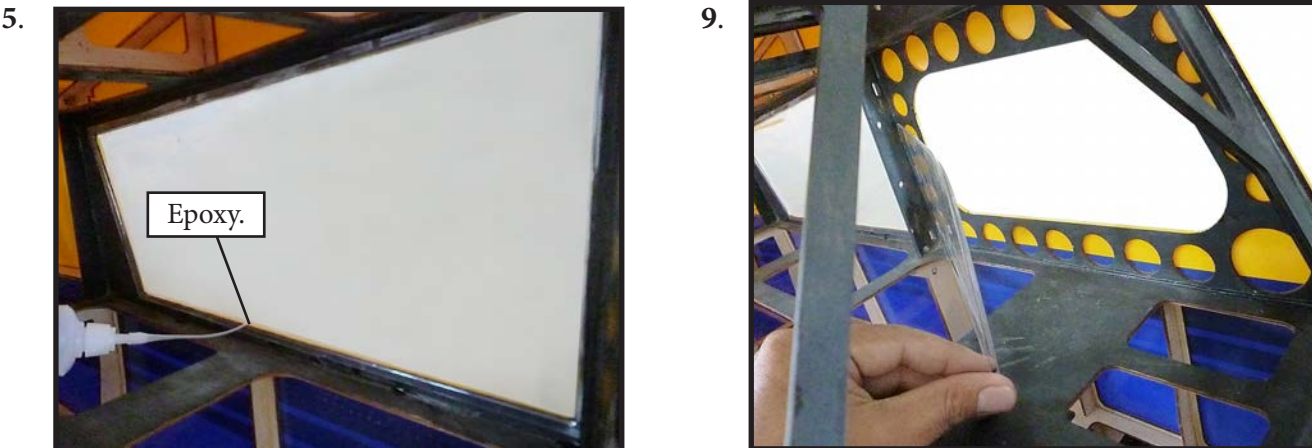
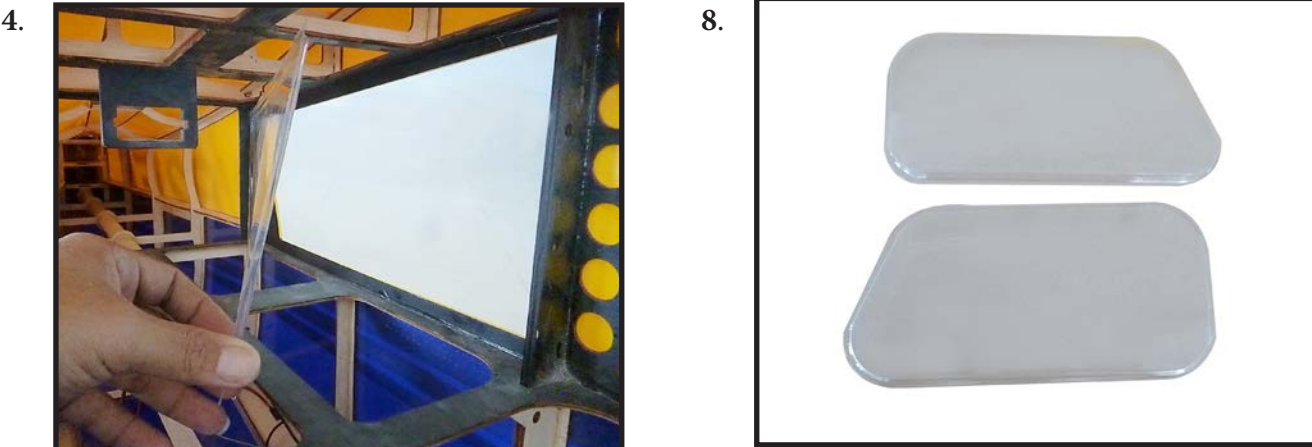
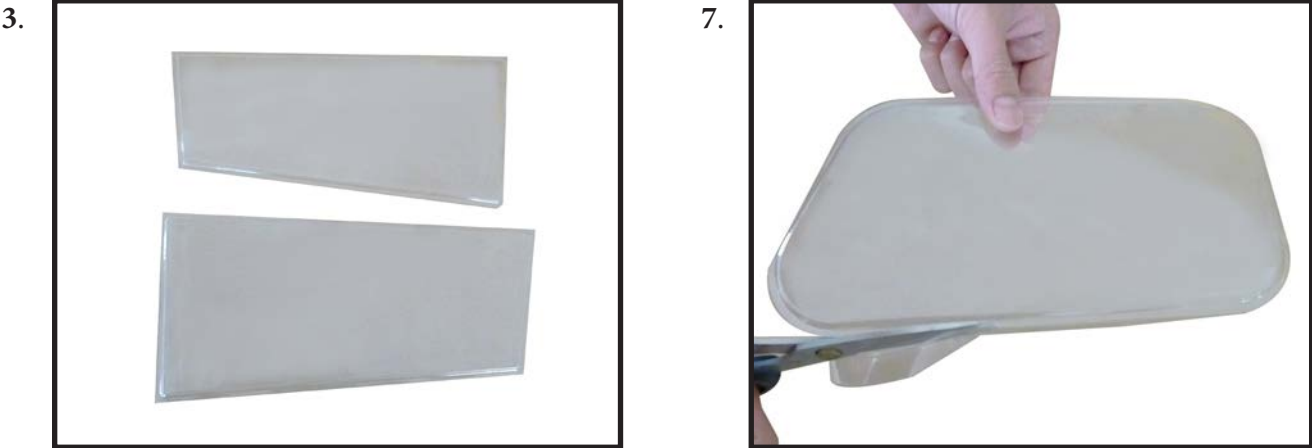

11.



15.



12.



16.



13.



17.



14.



18.



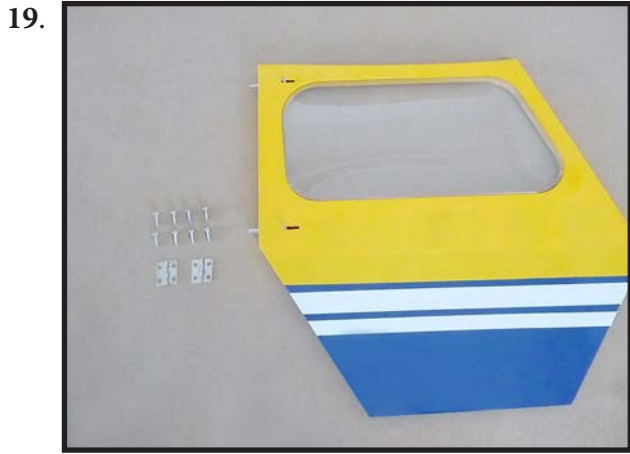

**INSTALLATION PILOT AND CANOPY**

Locate items necessary to install pilot and canopy.

1.



A scale pilot is included with this ARF. The Pilot included fitting well to the cockpit. (or you can order others scale pilot figures made by SG Models. They are available at SG Models distributors.)

If you are going to install a pilot figure, please use a sanding bar to sand the base of the figure so that it is flat.

Position the pilot figure on the canopy floor as show. Locate the oval shaped on the canopy floor and remove the covering. Use epoxy to glue this into the base of the pilot figure and glue the cockpit panel in place with C/A glue, please see pictures as shown.

2.



3.

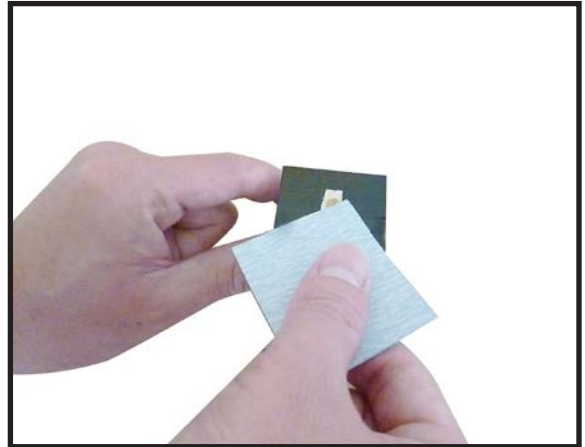

4.

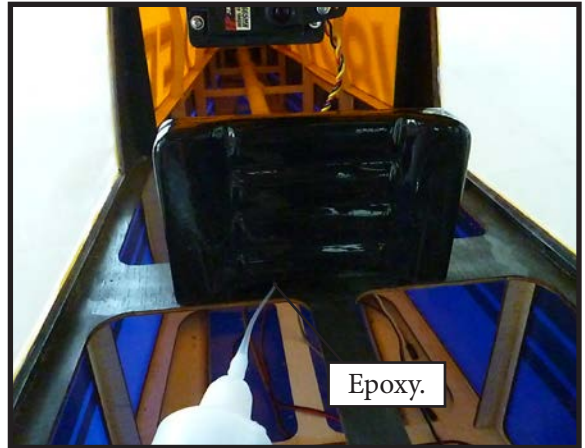

5.

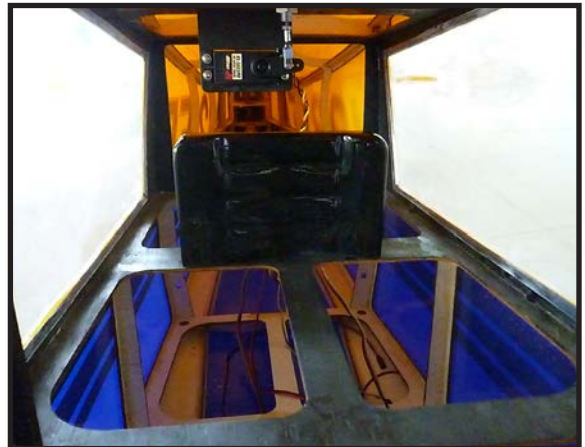

6.



7.



11.

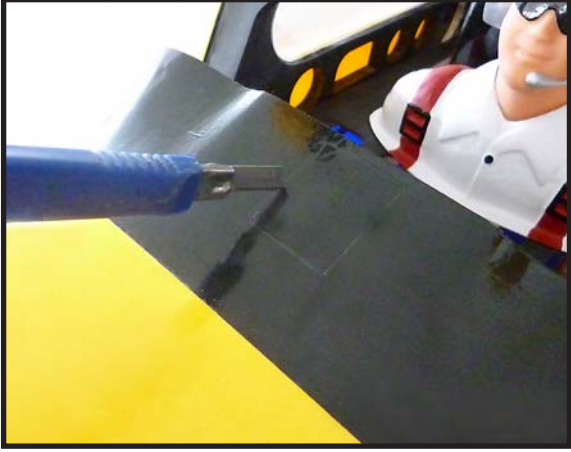

8.



12.



9.



13.



10.

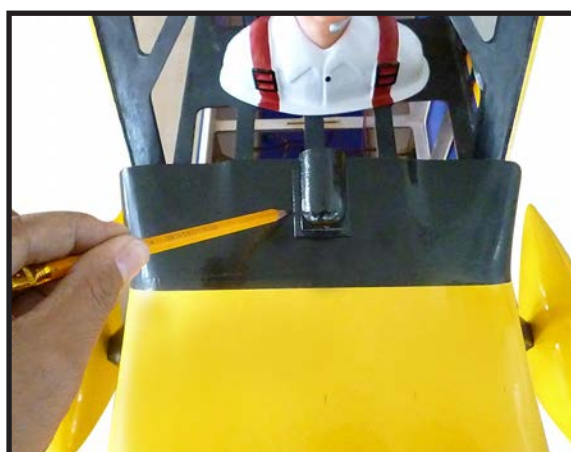

14.





Epoxy canopy onto the fuselage. Trace around the canopy and onto the fuselage using a epoxy.

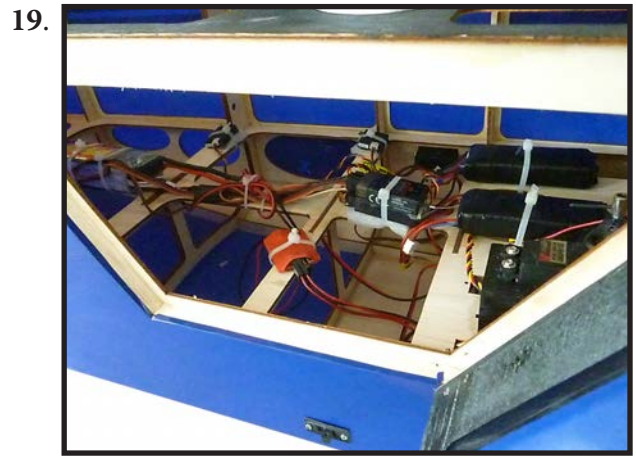
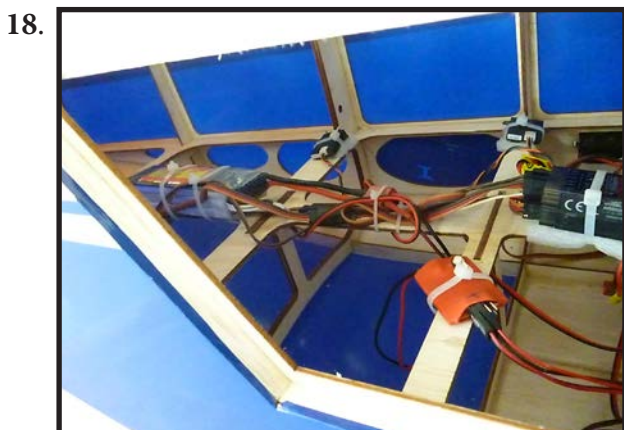

**ATTCHMENT WING-FUSELAGE**

Attach the aluminiu, thube into fuselage.



3.



7.



4.

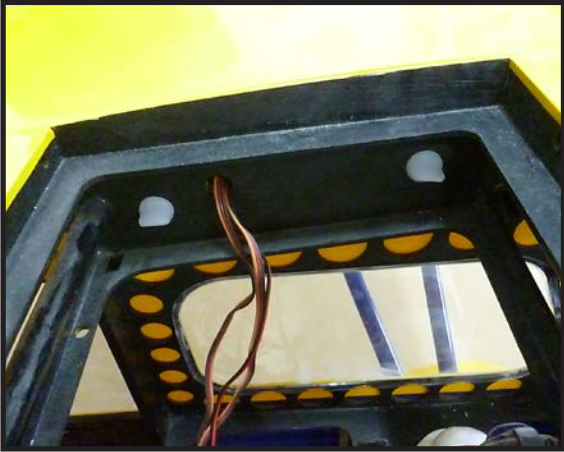

8.



5.



9.

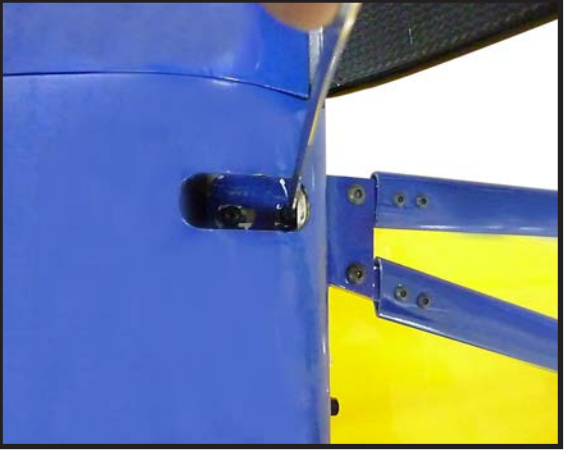

6.



10.

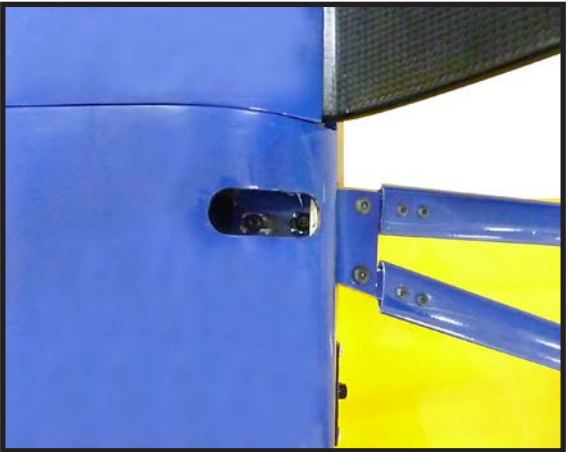



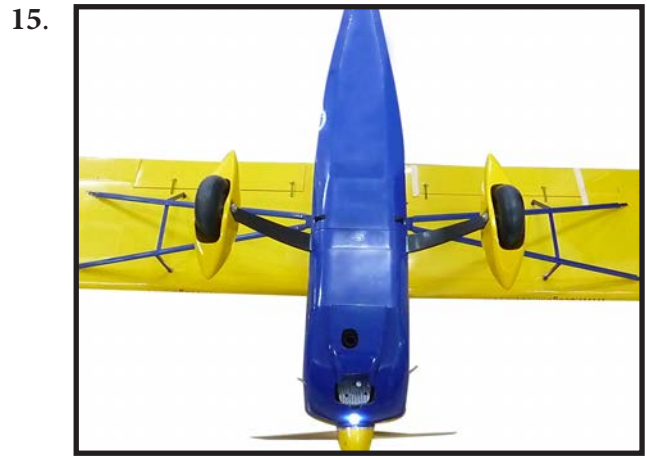
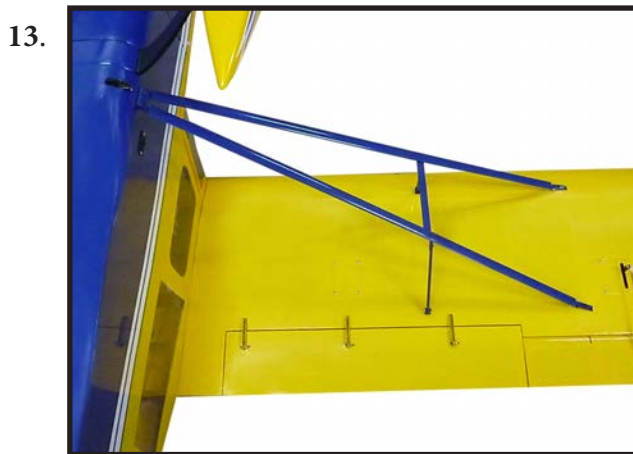
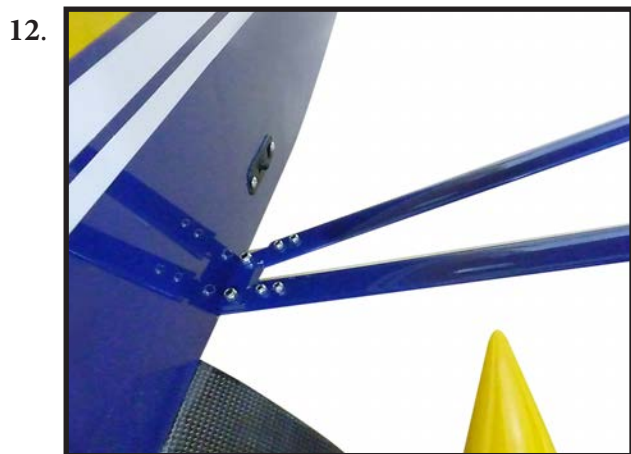

**INSTALLING TOW RELEASE FOR  
SAIL PLANE.**

Screw the aero-tow mechanism into the hole just behind the canopy, and apply thread-lock fluid to prevent the coupling and nut from working loose.

The aluminium part must be shortened enough so that the clevis can move freely, adjust the rods accordingly

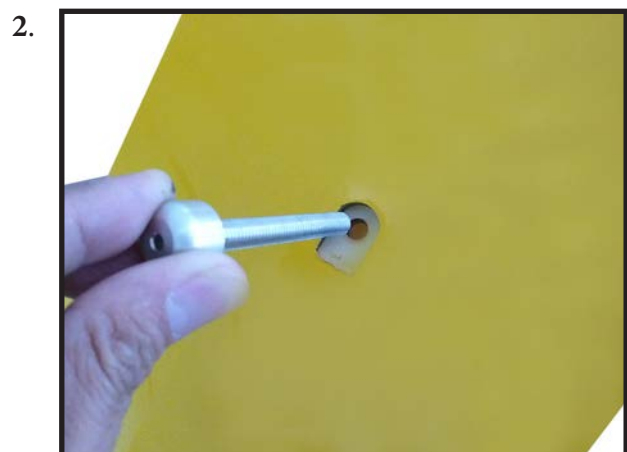

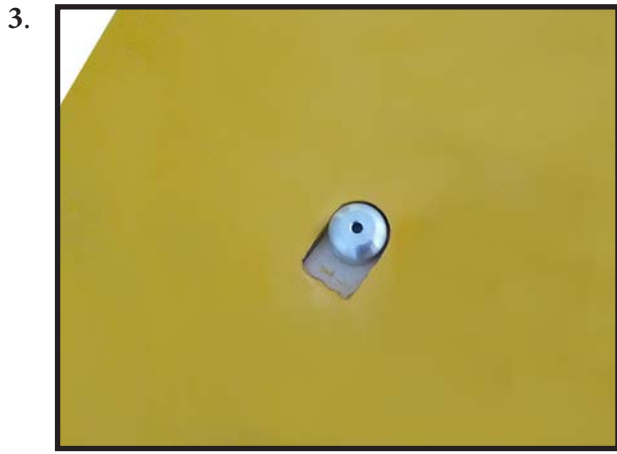

It is best to operate the aero-tow release mechanism using a momentary switch mounted on the joystick. Th servo travel must be set accordingly.

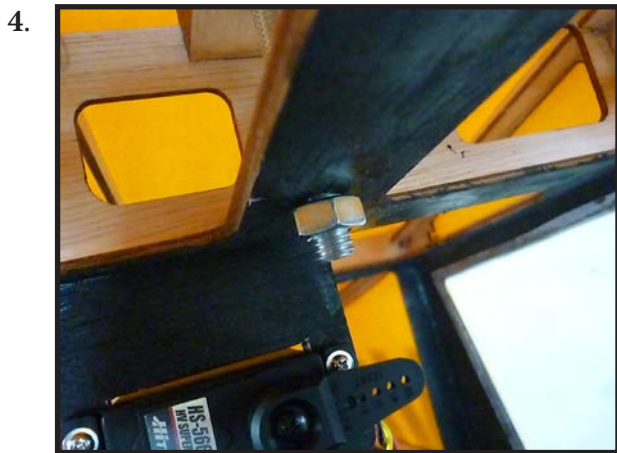

**INSTALLING NEEDED ANTEN**

Parts requirement. See pictures below.

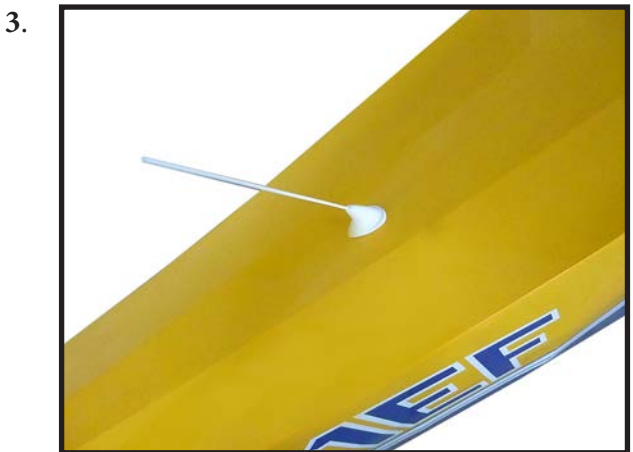
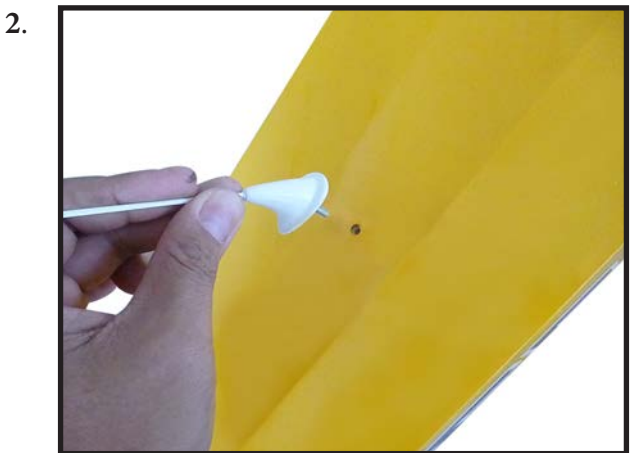
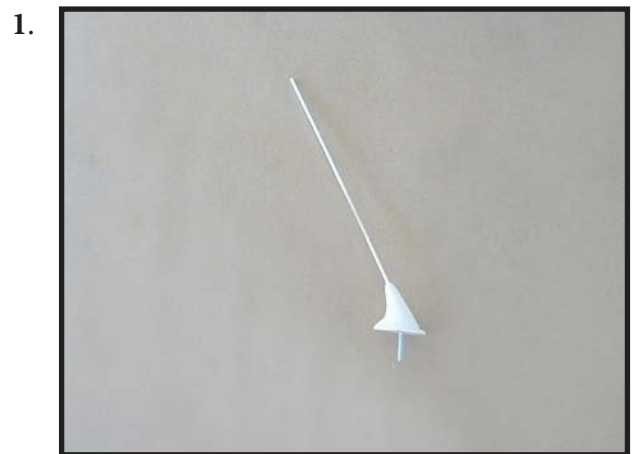

## APPLY THE DECALS

If all the decals are precut and ready to stick. Please be certain the model is clean and free from oily fingerprints and dust. Position decal on the model where desired, using the photos on the box and aid in their location.

If all the decals are not precut, please use scissors or a sharp hobby knife to cut the decals from the sheet. Please be certain the model is clean and free from oily fingerprints and dust. Position decal on the model where desired, using the photos on the box and aid in their location.

## BALANCING

It is critical that your airplane be balanced correctly. Improper balance will cause your plane to lose control and crash. THE CENTER OF GRAVITY IS LOCATED **170MM** BACK FROM THE LEADING EDGE OF THE WING AT THE WING ROOT.

Mount the wing to the fuselage. Place a piece of masking tape on the top of each wing 170mm back from the leading edge at the wing root.

With the model inverted, place your fingers on the masking tape and carefully lift the plane. This is the point at which your model should balance for your first flights. Later, you may wish to experiment by shifting the balance up to 10mm forward or back to change the flying characteristics. Moving the balance forward may improve the smoothness and arrow-like tracking, but it may then require more speed for take off and make it more difficult to slow down for landing. Moving the balance aft makes the model more agile with a lighter and snappier "feel". In any case, please start at the location we recommend.

\*If possible, first attempt to balance the model by changing the position of the receiver battery and receiver. If you are unable to obtain good balance by doing so, then it will be necessary to add weight to the nose or tail to achieve the proper balance point.

With the wings attached to the fuselage, all parts of the model installed ( ready to fly), and empty fuel tanks, hold the model at the marked balance point with the stabilizer level.

Lift the model. If the tail drops when you lift, the model is "tail heavy" and you must add weight\* to the nose. If the nose drops, it is "nose heavy" and you must add weight\* to the tail to balance.

1.

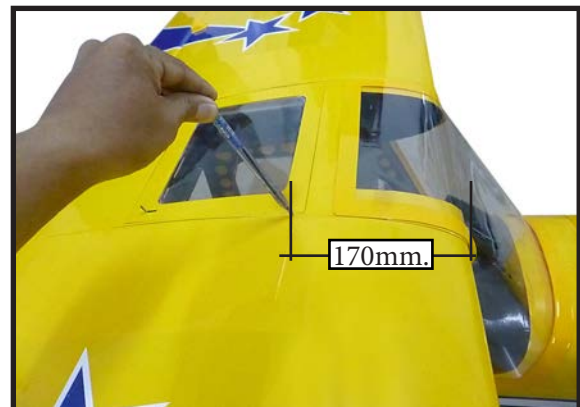

## CONTROL THROWS

### Ailerons:

High Rate :

Up : 40 mm

Down : 40 mm

Low Rate :

Up : 70 mm

Down : 70 mm

### Elevator:

High Rate :

Up : 60 mm

Down : 60 mm

Low Rate :

Up : 100 mm

Down : 100 mm

### Rudder:

High Rate :

Right : 50 mm

Left : 50 mm

Low Rate :

Right : 70 mm

Left : 70 mm

### Flap:

Mid : 40mm

Full : 140 mm

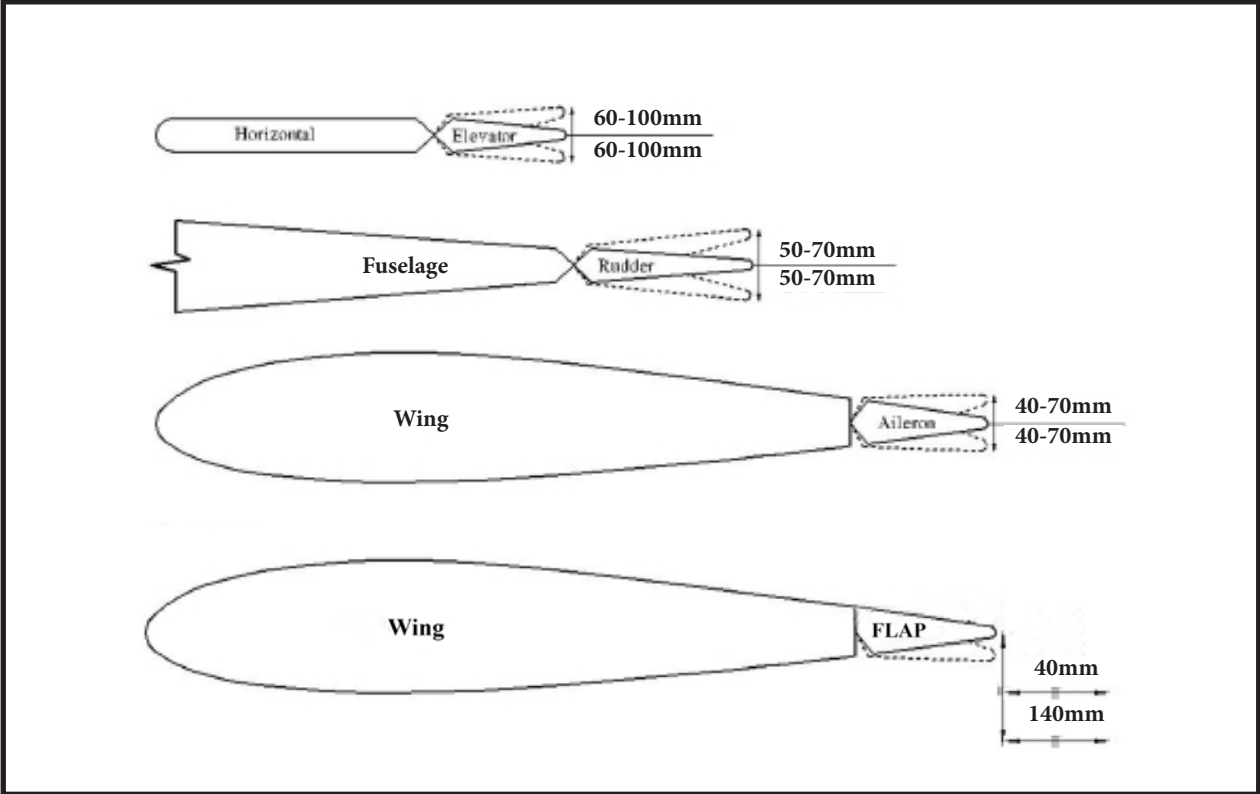

## FLIGHT PREPARATION

Check the operation and direction of the elevator, rudder, ailerons and throttle.

- A) Plug in your radio system per the manufacturer's instructions and turn everything on.
- B) Check the elevator first. Pull back on the elevator stick. The elevator halves should move up. If they do not, flip the servo reversing switch on your transmitter to change the direction.
- C) Check the rudder. Looking from behind the airplane, move the rudder stick to the right. The rudder should move to the right. If it does not, flip the servo reversing switch on your transmitter to change the direction.
- D) Check the throttle. Moving the throttle stick forward should open the carburetor barrel. If it does not, flip the servo reversing switch on your transmitter to change the direction.
- E) From behind the airplane, look at the aileron on the right wing half. Move the aileron stick to the right. The right aileron should move up and the other aileron should move down. If it does not, flip the servo reversing switch on your transmitter to change the direction.

## PREFLIGHT CHECK

- 1) Completely charge your transmitter and receiver batteries before your first day of flying.
- 2) Check every bolt and every glue joint in the **DECATHLON 60-85cc-3D** to ensure that everything is tight and well bonded.
- 3) Double check the balance of the airplane. Do this with the fuel tank empty.
- 4) Check the control surfaces. All should move in the correct direction and not bind in any way.
- 5) If your radio transmitter is equipped with dual rate switches double check that they are on the low rate setting for your first few flights.
- 6) Check to ensure the control surfaces are moving the proper amount for both low and high rate settings.
- 7) Check the receiver antenna. It should be fully extended and not coiled up inside the fuselage.
- 8) Properly balance the propeller. An out of balance propeller will cause excessive vibration which could lead to engine and/or airframe failure.

*We wish you many safe and enjoyable flights  
with your DECATHLON 60-85cc-3D .*

*If you have any queries, or are interested in our products,  
please feel free to contact us*

**Factory :** 12/101A - Hamlet 4 - Le Van Khuong Street - Dong Thanh Ward -  
Hoc Mon District - Ho Chi Minh City - Viet Nam.

**Office :** 62/8 Ngo Tat To Street - Ward 19 - Binh Thanh District - Ho Chi Minh  
City - Viet Nam

**Phone :** 848 - 86622289 or 848- 36018777

**Website :** [www.SeagullModels.com](http://www.SeagullModels.com)

**Email :** [Sales@seagullmodels.com](mailto:Sales@seagullmodels.com)

**Facebook :** [www.facebook.com/SeaGullModels](http://www.facebook.com/SeaGullModels).